

AD-A142 508

S JUN 21 1984 D
A

Reproduced From
Best Available Copy

Approved for public release; No
limitation on distribution

20000803096

ADA142508

PREFACE

This Weapons File has been prepared by AD/XRP to provide unclassified technical data on air launched weapons and munitions. The file is broken into four major categories: Air-to-Air Missiles, Guided Weapons, Unguided Weapons and Submunitions. A more detailed classified Weapons Catalogue is also available which provides performance data.

The data under AIRCRAFT indicates a typical loadout as configured for the Nonnuclear Armament Plan (NAP).

This file has been computerized for easy updating and it is our intent to expand and update this file on an annual basis; therefore, your comments on improvements would be appreciated, and should be directed to Mr Larry Roesler or Mr Lynn Deibler, AD/XRPT, Eglin AFB, FL 32542.

SEARCHED
SERIALIZED
JUN 21 1984
A

This document has been approved for public release and sale; its distribution is unlimited.

TABLE OF CONTENTS

I. AIR-TO-AIR MISSILES	PAGE
AIM-4F (FALCON)	1
AIM-4G (FALCON)	2
AIM-7E-2 (SPARROW)	3
AIM-7F (SPARROW)	4
AIM-7M (SPARROW)	5
AIM-9L (SIDEWINDER)	6
AIM-9M (SIDEWINDER)	7
AIM-54 (PHOENIX)	8
AIM-120 (AMRAAM)	9
ASRAAM	10
EMRAAT	11
II. GUIDED WEAPONS	
AGM-12C (BULLPUP)	12
AGM-45 (SHRIKE)	13
AGM-53A (CONDOR)	14
AGM-62B (WALLEYE II)	15
AGM-65A/B (MAVERICK)	16
AGM-65D (MAVERICK)	17
AGM-65F (MAVERICK)	18
AGM-78 (STANDARD ARM)	19
AGM-84 (HARPOON)	20
AGM-88 (HARM)	21
AGM-109H (MRASM)	22
AGM-109I (MRASM)	23
AGM-130A	24
AGM-130B	25
ASSAULT BREAKER	26
AXE	27
BACKBREAKER	28
HELLFIRE	29
JTACMS	30
LSD	31
LOCUST	32
ACW	33
SPW	34
GBU-10C/D (LGB)	35



II. GUIDED WEAPONS (CONT'D)	PAGE
GBU-12B/B (LGB)	36
GBU-15 (V) 1/B	37
GBU-15 (V) 2/B	38
GBU-15 (V) 3/B	39
GBU-20 (V) 2/B (PWW)	40
GBU-22 (LLLGB)	41
GBU-24 (LLLGB)	42
HTW	43
LLGB (AAJB)	44
III. UNGUIDED WEAPONS	
MK-20 (ROCKEYE)	45
MK-82	46
MK-82 (BSU-49)	47
MK-84	48
MK-84 (BSU-50)	49
MK-84 (IMPROVED)	50
M-117	51
M-118	52
CBU-52	53
CBU-58	54
CBU-59 (APAM)	55
CBU-71B	56
CBU-72/B (FAE)	57
CBU-87/B (CEM)	58
CBU-89/B (GATOR)	59
CBU-90/B (ACM)	60
CBU-92/B (ERAM)	61
DURANDAL	62
GPU-5A	63
GAU-8 (STABILIZED)	64
SUU-30A/B	65
SUU-54	66
SUU-65/B	67
WASP POD	68

IV. SUBMUNITIONS	PAGE
BLU-61A/B	69
BLU-63/B	70
BLU-77/B	71
BLU-80/B (BIGEYE)	72
BLU-81/B (STAM)	73
BLU-91/B (GATOR)	74
BLU-92/B (GATOR)	75
BLU-95/B	76
BLU-97/B (CEB)	77
BLU-99/B (ACM)	78
BLU-101/B (ERAM)	79
BLU-106 (BKEP)	80
BLU-108 (SFW)	81
M-74	82
MK-118	83
AMIS	84
BTM	85
HVM	86
RIM	87
SADARM	88
TGSM	89
VAM	90
WASP MISSILE	91

AIR-TO-AIR
MISSILES

TARGETS AIRCRAFT

SHORT RANGE

NOMENCLATURE AIM-4G	NAME FALCON
---------------------	-------------

WEAPON CHARACTERISTICS

WEIGHT-146 Lbs 66 kg
LENGTH-82.5 In 184.5 cm
DIAMETER-6.64 IN 16.9 CM
GUIDANCE-Infrared
CONTROLS-TAIL HYDRAULIC
AUTOPILOT-ANGLE RATE
PROPULSION-BOOST 4420 LBS SUSTAIN 635LBS 63SEC/4.09SEC
WARHEAD-BLAST 8 65 LBS
FUZE- CONTACT LEADING EDGE OF FINS

PICTORIAL

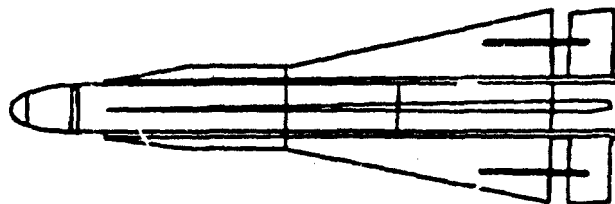

EMPLOYMENT OPTIONS

AIRCRAFT
F-106
F-102

ENGAGEMENT SYSTEMS
None

LAUNCHER
LE-6

PROGRAM MANAGEMENT
CONTRACTOR-HUGHES
UNIT COST-
STATUS-INVENTORY
NEXT EVENT-
REFERENCE-JMEM

LIMITATIONS
70000 FT ALT
TARGET SPEED
MAX 1.7M
HIT TO KILL
16 SEC
REACTION TIME

TARGETS AIRCRAFT

SHORT RANGE

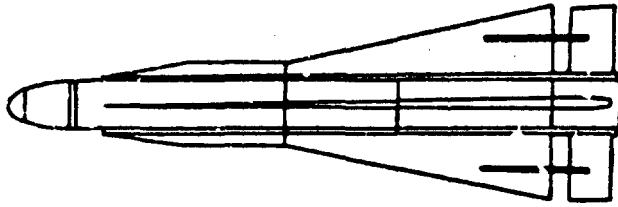
NOMENCLATURE AIM-4C		NAME FALCON
WEAPON CHARACTERISTICS		
WEIGHT-146 Lbs 66 kg LENGTH-82.5 In 184.5 cm DIAMETER-6.64 IN 16.9 CM GUIDANCE-Infrared CONTROLS-TAIL HYDRAULIC AUTOPILOT-ANGLE RATE PROPULSION-BOOST 4420 LBS SUSTAIN 635LBS 63SEC/4.09SEC WARHEAD-BLAST 8.65 LBS FUZE- CONTACT LEADING EDGE OF FINS		
PICTORIAL		
		
EMPLOYMENT OPTIONS		
AIRCRAFT F-105 F-102	ENGAGEMENT SYSTEMS None	LIMITATIONS 70000 FT ALT TARGET SPEED MAX 1.7M HIT TO KILL
LAUNCHER I.E-6		16 SEC REACTION TIME
PROGRAM MANAGEMENT CONTRACTOR-HUGHES UNIT COST- STATUS-INVENTORY NEXT EVENT- REFERENCE-JMEN		

TARGETS AIRCRAFT

MEDIUM RANGE

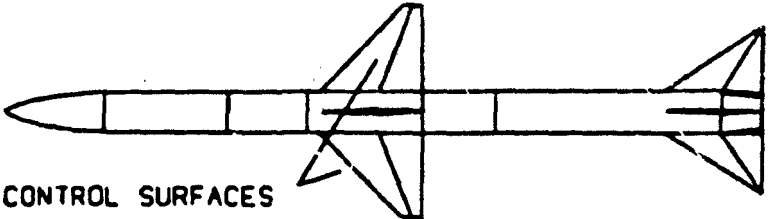
NOMENCLATURE AIM-7E-2		NAME SPARROW
WEAPON CHARACTERISTICS		
WEIGHT-427 Lbs LENGTH-145 In DIAMETER-8 In. GUIDANCE-Semi-active radar & HOJ CONTROLS-Wing (hydraulic) AUTOPILOT-Roll rate PROPULSION-Boost 7,600 Lbs 2.9 sec WARHEAD-Expanding rod 66.8 Lbs MK38 FUZE-Proximity, RF & contact		
PICTORIAL		
 <p>CONTROL SURFACES</p>		
EMPLOYMENT OPTIONS		
AIRCRAFT		LIMITATIONS
F-4		LAUNCH MACH 0.7-2.2
F-15		MAX TGT SPEED MACH 2.2
F-14		LAUNCH ALT 25-40,000 FT
		MAX TOF 40 SEC
LAUNCHER		
AERO-7A		
LAU-105/A		
ENGAGEMENT SYSTEM		
AVC-9		
PROGRAM MANAGEMENT		
CONTRACTOR-NAVY TRAYTHEON		
UNIT COST-		
STATUS-INVENTORY		
NEXT EVENT-		
REFERENCE-JMEM		

TARGETS AIRCRAFT

MEDIUM RANGE

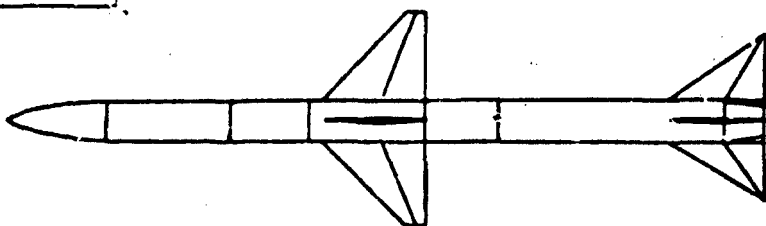
NOMENCLATURE AIM-7F		NAME SPARROW
WEAPON CHARACTERISTICS		
WEIGHT-514 Lbs LENGTH-145 In DIAMETER-8 In GUIDANCE-Semi-active radar & HOJ CONTROLS-Wing (hydraulic) AUTOPILOT-Roll rate PROPULSION-Boost 5750 Lbs 4 5sec sustain 1016 Lbs 11 sec WARHEAD-Continuous rod 84 Lbs FUZE-Proximity RF & contact		
PICTORIAL		
		
EMPLOYMENT OPTIONS		
AIRCRAFT		LIMITATIONS
F-4 (4)		LAUNCH MACH 0.7-2.5
F-15 (4)		MAX TGT SPEED MACH 2.2
F-14 (4)		LAUNCH ALT 25-40KFT
LAUNCHER		
AERO-7A		
LAU-106/A		
ENGAGEMENT SYSTEMS		
AVC-9		
PROGRAM MANAGEMENT		
CONTRACTOR-NAVY (RAYTHEON & GENERAL DYNAMICS)		
UNIT COST-\$52,500		
STATUS-INVENTORY		
NEXT EVENT-		
REFERENCE-JMEM		

TARGETS AIRCRAFT

MEDIUM RANGE

NOMENCLATURE AIM -7M NAME SPARROW

WEAPON CHARACTERISTICS

WEIGHT-514 Lbs
LENGTH-145 In
DIAMETER-8 In
GUIDANCE-Semi-active monopulse radar & HOJ
CONTROLS-Wing (hydraulic)
AUTOPILOT-Roll rate
PROPULSION-Boost 5750 Lbs 4 Sec sustain 1018 Lbs 11 sec
WARHEAD-Continuous rod 84 Lbs
FUZE-Proximity RF & contact

PICTORIAL

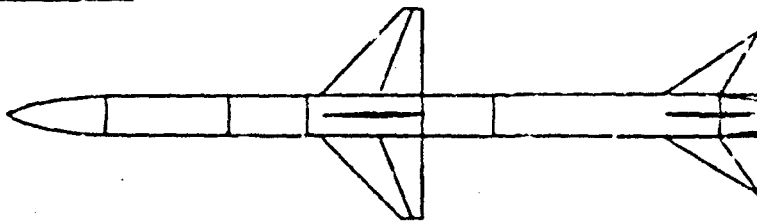

EMPLOYMENT OPTIONS

AIRCRAFT

F-4 (4)
F-15 (4)
F-14 (4)

LIMITATIONS

LAUNCH MACH 0.7-2.5
MAX TGT. SPEED MACH 2.2
LAUNCH ALT 25-40KFT

LAUNCHER

AERO-7A
LAU-103/A

ENGAGEMENT SYSTEMS

AVC-9

PROGRAM MANAGEMENT

CONTRACTOR-NAVY (RAYTHEON)
UNIT COST-073,300
STATUS-INVENTORY
NEXT EVENT-
REFERENCE-JHEM

TARGETS AIRCRAFT

SHORT RANGE

NOMENCLATURE AIM-9L

NAME SIDEWINDER

WEAPON CHARACTERISTICS

WEIGHT- 19 lbs
LENGTH- 113 in
DIAMETER- 5 in
GUIDANCE- IR InSb detector
CONTROLS- Canard torque balanced
AUTOPILOT- none
PROPULSION- Boost 2660 lbs thrust
WARHEAD- Annular blast frg 20 8 lbs
FUZE- Contact and active optical

PICTORIAL

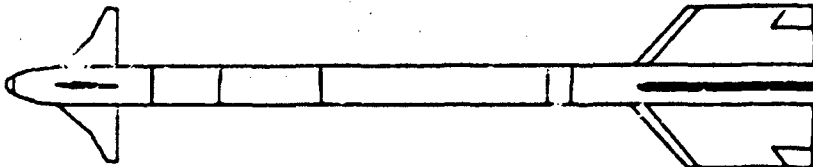

EMPLOYMENT OPTIONS

AIRCRAFT

F-16
F-15
F-4
F-14
F-5
A-10

LIMITATIONS

Does not
limit F-16
capability

LAUNCHER

AERO-3/B

PROGRAM MANAGEMENT

CONTRACTOR- NAVY (RAYTHEON & FORD)
UNIT COST- \$39,300
STATUS- INVENTORY
NEXT EVENT-
REFERENCE- JMEM

TARGETS AIRCRAFT

SHORT RANGE

NOMENCLATURE AIM-9M	NAME SIDEWINDER
---------------------	-----------------

WEAPON CHARACTERISTICS

WEIGHT- 191 lbs
LENGTH- 113 in
DIAMETER- 5 in
GUIDANCE- IR InSb detector
CONTROLS- Canard torque balanced
AUTOPILOT- none
PROPULSION- Boost 2660 lbs thrust Low smoke
WARHEAD- Annular blast frg 20 8 lbs
FUZE- Contact and active optical

PICTORIAL

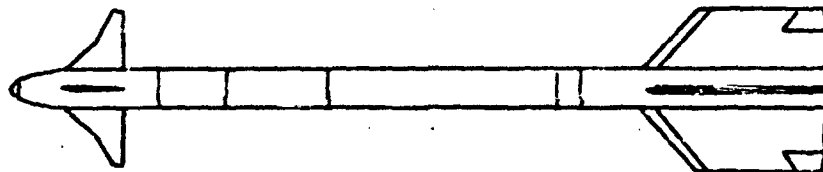

EMPLOYMENT OPTIONS

AIRCRAFT

F-16
F-15
F-4
F-14
F-5
A-10

LIMITATIONS

Does not
limit F-16
capability

LAUNCHER

AERO-3/B
LAU-114/A

PROGRAM MANAGEMENT

CONTRACTOR- NAVY (RAYTHEON & FORD)
UNIT COST- \$88,833
STATUS- INVENTORY
NEXT EVENT-
REFERENCE- JMEM

TARGETS AIRCRAFT

LONG RANGE

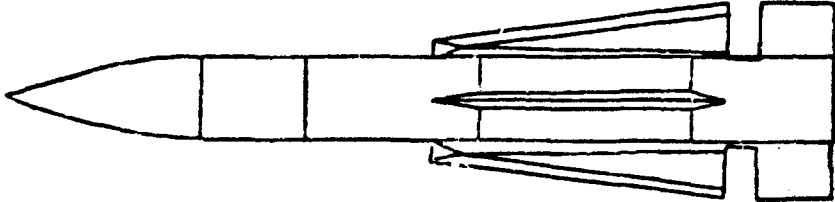
NOMENCLATURE AIM-54	NAME PHOENIX
WEAPON CHARACTERISTICS	
WEIGHT-987 Lbs LENGTH-156 In DIAMETER-15 In GUIDANCE-Active and semi-active radar CONTROLS-Tail (hydraulic) AUTOPILOT-3 axis rate PROPULSION-Boost 4000 Lbs 30 sec WARHEAD-Continuous rod 133 Lbs FUZE-Proximity and contact	
PICTORIAL	
	
EMPLOYMENT OPTIONS	
AIRCRAFT F-14 (4)	
ENGAGEMENT SYSTEM AWG-9 RADAR	
LIMITATIONS LAUNCH 1.0-2.5 MACH SEA LEVEL TO 80,000 FT. MAX TARGET SPEED MACH 4.2	
LAUNCHER MAU-83A OR 84A	
PROGRAM MANAGEMENT CONTRACTOR-NAVY (HUGHES) UNIT COST- STATUS-INVENTORY NEXT EVENT- REFERENCE-JMEM	

TARGETS AIRCRAFT

MEDIUM RANGE

NOMENCLATURE AIM-120

NAME AMRAAM

WEAPON CHARACTERISTICS

WEIGHT- 329 LBS.
LENGTH- 144 IN
DIAMETER-7 IN
GUIDANCE-[inertial/Command inertial] and active radar
CONTROLS-Tail
AUTOPILOT-3 AXIS ACCELERATION
PROPULSION-Boost Sustain reduced smoke
WARHEAD- 49 LBS FRAG
FUZE- RF

PICTORIAL

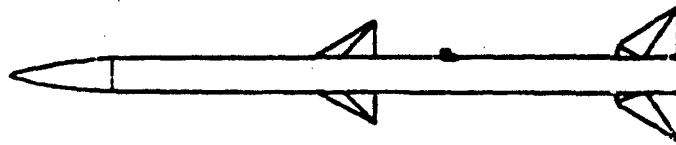

EMPLOYMENT OPTIONS

AIRCRAFT

F-15
F-16
F-14
F-18
TORONADO

LAUNCHER

NEW RAIL LAUNCHER
MODIFIED EJECT LAUNCHER

ENGAGEMENT SYSTEMS

A/C RADAR
INERTIAL SYSTEM

PROGRAM MANAGEMENT

CONTRACTOR- HUGHES
UNIT COST-
STATUS- FSD
NEXT EVENT- PREPRODUCTION - 1985
REFERENCE- YM MR. MCCARTHY 872-2048

TARGETS AIRCRAFT

SHORT RANGE

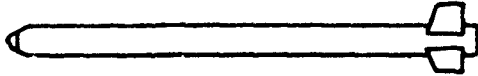
NOMENCLATURE	NAME ASRAAM
<p>WEAPON CHARACTERISTICS</p> <p>WEIGHT- 130 LBS LENGTH- 90 IN DIAMETER- 7 IN GUIDANCE- IR CONTROLS- TAIL AUTOPILOT- TBD PROPULSION- BOOST SUSTAIN WARHEAD- BLAST FRAG FUZE- CONTACT / PROX.</p>	
<p>PICTORIAL</p> 	
<p>EMPLOYMENT OPTIONS</p> <p>AIRCRAFT F-15 F-16 F-18 TORONADO ATF</p> <p>LAUNCHER AIM-9L OR AIM-120 COMPATABLE</p> <p>ENGAGEMENT SYSTEMS HUD HELMET MOUNTED DISPLAY</p> <p>PROGRAM MANAGEMENT CONTRACTOR- U K. AND FRG UNIT COST- STATUS- NEXT EVENT- ENGINEERING DEV 1995 REFERENCE- MAJ MCMULLAN AV 872-8110</p>	

TARGETS AIRCRAFT

LONG RANGE

NOMENCLATURE

NAME EMRAAT

WEAPON CHARACTERISTICS

WEIGHT-325 Lbs
LENGTH-144 IN
DIAMETER-7 In
GUIDANCE-Passive-active all weather seeker (PAAS)
CONTROLS-Tail electric actuators
AUTOPILOT-3 axis accel adaptive digital
PROPULSION-Boost 10,000 Lbs 2sec sustain 50-1000 Lbs 100 sec
WARHEAD-40-50 Lbs SAW/Self-forging frag aimed ellipical
FUZE-Active RF/IR adaptive, seeker integrated

Propulsion is ducted rocket or canjet

PICTORIAL

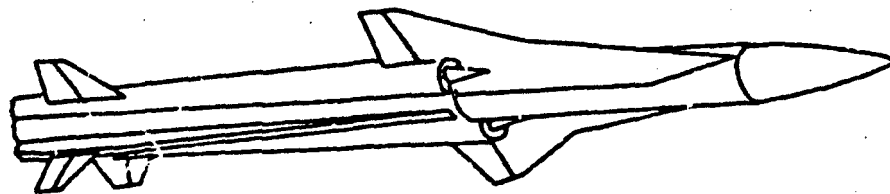

EMPLOYMENT OPTIONS

AIRCRAFT

F-15
F-14
NATO
F-16

LAUNCHER

AMRAAM LAUNCHERS

ENGAGEMENT SYSTEM

IRST
FCS/TWS (3RD PARTY FCS)
DATA LINK (AMRAAM) JTIDS
ECM/EW TRACK SYSTEM

PROGRAM MANAGEMENT

CONTRACTOR-VOUGHT
UNIT COST-AIM-120 + \$20K
STATUS-CONCEPT DEVELOPMENT
NEXT EVENT-TECH DEMO 1988-1989
REFERENCE-MR. BUTLER 872-2088

**GUIDED
WEAPONS**

TARGETS HARD FIXED

SHORT RANGE

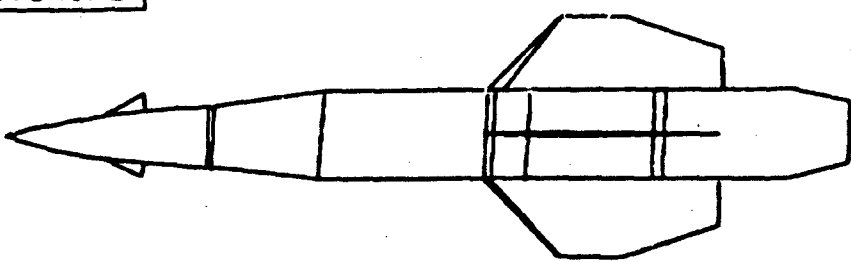
NOMENCLATURE	AGM-12C	NAME	BULL PUP
WEAPON CHARACTERISTICS			
WEIGHT-1789lb LENGTH-100 8in DIAMETER-17 3in GUIDANCE-PILOT VISUAL TRACK, VHF DL STEERING COMMAND CONTROLS-PNEUMATIC OPERATED CANARDS AUTOPILOT-ROLL REFERENCE CYRO PROPULSION-67,200 lb-sec WARHEAD-374lb blast frag FUZE-SELECTABLE IMPACT DELAY OR PROX			
PICTORIAL			
			
EMPLOYMENT OPTIONS			
AIRCRAFT F-4			
ENGAGEMENT SYSTEMS JOY STICK DATA LINK			
LIMITATIONS STRAIGHT AND LEVEL DELIVERY			
PROGRAM MANAGEMENT CONTRACTOR-MARTIN/THIokol UNIT COST- STATUS-INVENTORY NEXT EVENT- REFERENCE-JMEM			

TARGETS RADAR EMITTERS

MEDIUM RANGE

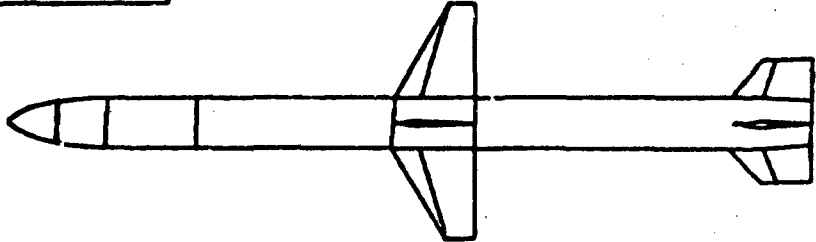
NOMENCLATURE AGM-45		NAME SHRIKE
WEAPON CHARACTERISTICS		
WEIGHT- 400lbs 181kg. LENGTH- 120in 304 8cm. DIAMETER- 8in 18 3cm GUIDANCE- passive RF, onirradiation CONTROLS- wing, hot gas AUTOPILOT- angle rate roll stabilized PROPULSION- boost 7000lbs sustain 10,450lbs WARHEAD- 151 Lbs patterned frag. MK 52, 68, 69 FUZE- proximity and contact MK 338 & MK 44		
PICTORIAL		
		
EMPLOYMENT OPTIONS		
AIRCRAFT F-4 (4) F-15 (4) F-16 A-7 A-10 B-52 F-105 (4)	LIMITATIONS SUSCEPTABLE TO RADAR SHUTDOWN	LAUNCHERS LAU-31/A AERO-5A-1
ENGAGEMENT SYSTEMS Audio control panel Altitude indicator APR-38		
PROGRAM MANAGEMENT CONTRACTOR- TEXAS INSTRUMENTS UNIT COST- \$28,000 STATUS- INVENTORY NEXT EVENT- REFERENCE- JMEM 3-23		

TARGETS HARD FIXED

MEDIUM RANGE

NOMENCLATURE	ACM-53A-1/2	NAME	CONDOR
--------------	-------------	------	--------

WEAPON CHARACTERISTICS

WEIGHT- 2130lb
LENGTH- 168/175 5in
DIAMETER-17in
GUIDANCE-EO WITH DATA LINK
CONTROLS-TAIL
AUTOPILOT-3 AXIS ACC
PROPULSION-BOOST 880lb (170sec)
WARHEAD- 650lb VDU-7/B
FUZE-MK 383 MOD 0 IMPACT OR 14msec DELAY

PICTORIAL

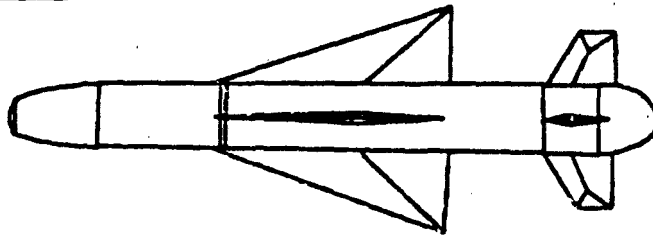

EMPLOYMENT OPTIONS

AIRCRAFT
A-0E

LAUNCHER
AERO 7A-R
MAUSA/A

ENGAGEMENT SYSTEMS
CONTROL POD

PROGRAM MANAGEMENT
CONTRACTOR-ROCKWELL
UNIT COST- \$200,000 (FY77)
STATUS- TERMINATED IN VALIDATION
NEXT EVENT-
REFERENCE- JMEM

TARGETS SHIPS

LONG RANGE

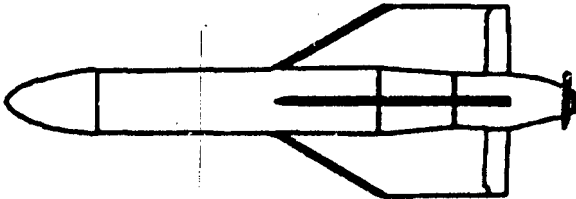
NOMENCLATURE AGM 62B		NAME: WALLEYE II
WEAPON CHARACTERISTICS WEIGHT-2340lb LENGTH-158in DIAMETER-18in GUIDANCE-EO CONTRAST TRACKER /DATA LINK CONTROLS-TAIL (HYDRAULIC) AUTOPILOT-ROLL CONTROL PROPULSION-NONE WARHEAD-2015lb LINEAR SHAPED CHARGE M58 FUZE-CONTACT WITH DELAY (35msec)		
PICTORIAL		
		
EMPLOYMENT OPTIONS		
AIRCRAFT F-4 (4) A-7 (4) A-4 (4)		
LAUNCHER PYLON MOUNTED MAU-12A/B		
ENGAGEMENT SYSTEMS RADAR SCOPE		
LIMITATIONS LAUNCH 3450mph--0.95M		
PROGRAM MANAGEMENT CONTRACTOR-MARTIN MARETTA UNIT COST- STATUS- INVENTORY NEXT EVENT- REFERENCE- JMEM		

TARGETS ARMOR

SHORT RANGE

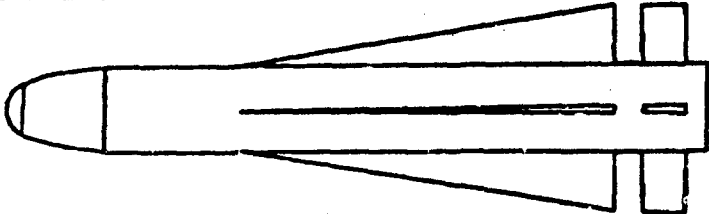
NOMENCLATURE: AGM-85A/B		NAME: MAVERICK
WEAPON CHARACTERISTICS		
WEIGHT- 465 LBS LENGTH- 97 7/8 in DIAMETER- 12 IN GUIDANCE- TV CONTROLS- TAIL AUTOPILOT- PURSUIT PROPULSION- BOOST SUSTAIN WARHEAD- SHAPED CHARGE 125 LBS FUZE- CONTACT		
PICTORIAL		
		
EMPLOYMENT OPTIONS		
AIRCRAFT		LIMITATIONS
F-4		MACH 5-1.5
A-7		BELOW 33 KFT
A-10		
F-16		LAUNCHER
		LAU-88A
ENGAGEMENT SYSTEMS		
TV DISPLAY		
JOY STICK		
PROGRAM MANAGEMENT		
CONTRACTOR- HUGHES		
UNIT COST- \$17,000		
STATUS- INVENTORY		
NEXT EVENT-		
REFERENCE- JMEM		

TARGETS - ARMOR

SHORT RANGE

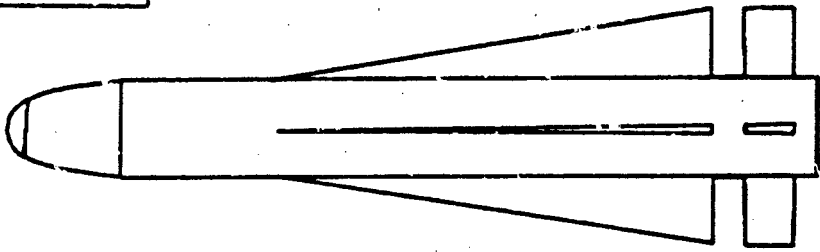
NOMENCLATURE AGM-65D		NAME MAVERICK
WEAPON CHARACTERISTICS		
WEIGHT- 485 LBS LENGTH- 97 7in DIAMETER-12IN GUIDANCE-IIR CONTROLS-TAIL AUTOPILOT-ROLL STABILIZED 3 AXIS PROPULSION-BOOST SUSTAIN WARHEAD- SHAPED CHARGE 125LBS FUZE- CONTACT		
PICTORIAL		
		
EMPLOYMENT OPTIONS		
AIRCRAFT		LAUNCHER
F-4 (4)	F-15 (4)	LAU-88A
A-7 (4)		LAU-117A
A-10 (4)		
F-16 (4)		
ENGAGEMENT SYSTEMS		
TV DISPLAY		
Joy stick		
Lantern pod planned		
LIMITATIONS		
MACH 5-1.5		
PROGRAM MANAGEMENT		
CONTRACTOR-HUGHES		
UNIT COST-\$90,000		
STATUS- PRODUCTION		
NEXT EVENT-IOC		
REFERENCE-		

TARGETS ARMOR & HARD FIXED

SHORT RANGE

NOMENCLATURE AGM-85F

NAME MAVERICK

WEAPON CHARACTERISTICS

WEIGHT- 675 LBS
LENGTH- 97 7in
DIAMETER-12IN
GUIDANCE-IR
CONTROLS-TAIL
AUTOPILOT-ROLL STABILIZED 3 AXIS
PROPULSION-BOOST SUSTAIN
WARHEAD- 300 LBS BLAST-FRAG
FUZE- CONTACT TIME DELAY

PICTORIAL

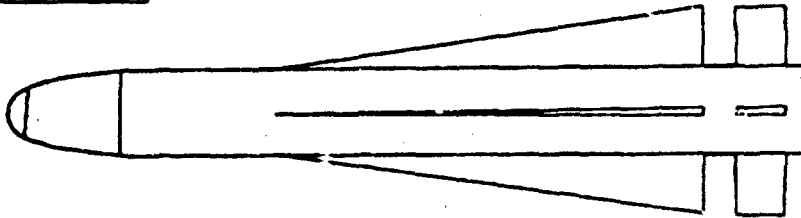

EMPLOYMENT OPTIONS

AIRCRAFT

F-4 (4) F-15 (4)
A-7 (4)
A-10 (4)
F-16 (4)

LAUNCHER

LAU-88A
LAU-117A

ENGAGEMENT SYSTEMS

TV DISPLAY
Joy stick

LIMITATIONS

MACH 5-15

PROGRAM MANAGEMENT

CONTRACTOR- HUGHES
UNIT COST-
STATUS- PRODUCTION
NEXT EVENT-
REFERENCE- JMEM

TARGETS EMITTERS

LONG RANGE

NOMENCLATURE AGM-78 NAME STANDARD ARM

WEAPON CHARACTERISTICS

WEIGHT- 1358 lbs.
LENGTH- 180 IN.
DIAMETER- 13.5 IN.
GUIDANCE- PASSIVE RADIATION HOMING
CONTROLS- TAIL
AUTOPILOT- THREE AXIS ADAPTIVE
PROPULSION- BOOST SUSTAIN 120,000 lbs-sec
WARHEAD- BLAST FRAGMENTATION 223 LBS MK 73 MOD 0,1
FUZE- ACTIVE OPTICAL PROX (DSU-10/B)

PICTORIAL

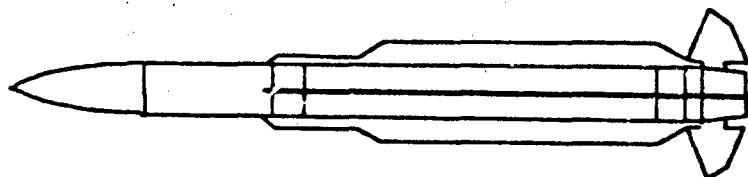

EMPLOYMENT OPTIONS

AIRCRAFT

F-4 (4)
F-105 (2)
A-6E

LAUNCHER

LAU-77
LAU-7F
LAU-80

ENGAGEMENT SYSTEMS

AVC-21
APR-35, 36, 37
ALR-69

PROGRAM MANAGEMENT

CONTRACTOR- GENERAL DYNAMICS
UNIT COST-
STATUS- INVENTORY
NEXT EVENT-
REFERENCE- JMEM 3-35

LIMITATIONS

MAX RANGE 65NM
MAX LAUNCH VELOCITY 2 DM

TARGETS SHIPS

LONG RANGE

NOMENCLATURE

ACM 84

NAME: HARPOON

WEAPON CHARACTERISTICS

WEIGHT-1100lb

LENGTH-151in

DIAMETER-13.5in

GUIDANCE-INS MIDCOURSE, ACTIVE RADAR TERMINAL

CONTROLS-TAIL

AUTOPILOT-INS

PROPULSION-TURBOJET SUSTAINER ENGINE

WARHEAD-500lb DESTEX

FUZE- CONTACT

PICTORIAL

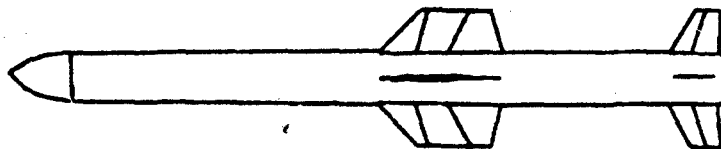

EMPLOYMENT OPTIONS

AIRCRAFT

P-3

S-3

A-7

A-6E

LAUNCHER

AERO 85A1

MAU-9A/A

AERO 7A-1

ENGAGEMENT SYSTEMS

INS INITIALIZATIONS

PROGRAM MANAGEMENT

CONTRACTOR-MCDONNELL DOUGLAS/IBM/TI

UNIT COST-

STATUS- INVENTORY

NEXT EVENT-

REFERENCE- JMEM

TARGETS EMITTERS

MEDIUM RANGE

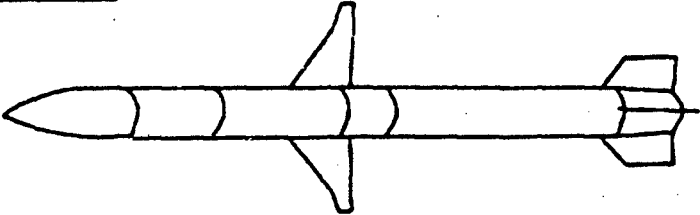
NOMENCLATURE AGM-88	NAME HARM
WEAPON CHARACTERISTICS WEIGHT- 760 LBS LENGTH- 164 IN DIAMETER- 10 IN GUIDANCE- ANTI-RADIATION CONTROLS- WING ELECTRO-MECHANICAL AUTOPILOT- 3 AXIS RATE PROPULSION- BOOST SUSTAIN 84,000 LBS-SEC LOW SMOKE WARHEAD- 146 LBS BLAST FRAC FUZE- PULSED LASER PROX. /CONTACT	
PICTORIAL 	
EMPLOYMENT OPTIONS AIRCRAFT F-4 (4) F-14 (6)	
ENGAGEMENT SYSTEMS APR-38 RWR	
LAUNCHER LAU-118	
PROGRAM MANAGEMENT CONTRACTOR-TEXAS INSTRUMENTS UNIT COST- \$280,000 STATUS-PRODUCTION NEXT EVENT- REFERENCE-JMEM 3-41	

TARGETS AIRFIELDS & RUNWAYS

LONG RANGE

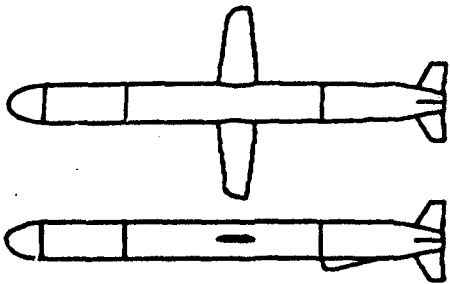
NOMENCLATURE . AGM-109H		NAME MRASM
WEAPON CHARACTERISTICS		
WEIGHT- 3000 Lbs LENGTH- 232 In DIAMETER- 20 3 In GUIDANCE- Inertial update CONTROLS- Tail AUTOPILOT- 3 axis acceleration PROPULSION- Turbojet WARHEAD- See submunitions below FUZE- See submunitions		
PICTORIAL		
		
EMPLOYMENT OPTIONS		
SUBMUNITIONS		ENGAGEMENT SYSTEMS
ACM AMIS BLU-63 BTM VAM CEB BKEP		INERTIAL SYSTEM
AIRCRAFT B-52 (12)		
PROGRAM MANAGEMENT		
CONTRACTOR- GENERAL DYNAMICS UNIT COST- \$840,700 STATUS- TERMINATED 1983 NEXT EVENT- REFERENCE- MAJ. VEISS AV 872-4151		

TARGETS HARD FIXED

LONG RANGE

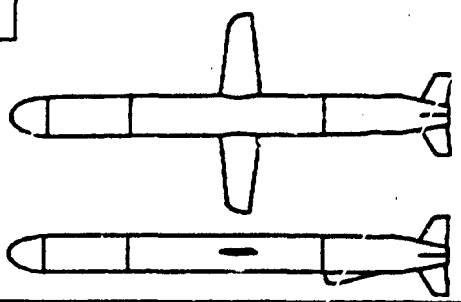
NOMENCLATURE AGM-109I		NAME MRASM VARIANT
WEAPON CHARACTERISTICS WEIGHT-3000 Lbs LENGTH-232 In DIAMETER-20 3 In GUIDANCE-Inertial update/IIR terminal (DSMAC) CONTROLS-Tail AUTOPILOT-3 axis acceleration PROPULSION-Turbojet WARHEAD-WDU-25 A/B 967 Lbs penetrator with 357 Lbs. H.E. FUZE-FMU-138/B		
PICTORIAL 		
EMPLOYMENT OPTIONS		
AIRCRAFT B-52D (11)		ENGAGEMENT SYSTEMS INERTIAL SYSTEM
PROGRAM MANAGEMENT CONTRACTOR- GENERAL DYNAMICS UNIT COST- \$540,700 STATUS- TERMINATED NEXT EVENT- REFERENCE- MAJ. WEISS AV 872-4151		

TARGETS HARD POINT TARGETS

MEDIUM RANGE

NOMENCLATURE AGM-130A

NAME POWERED GBU-15

WEAPON CHARACTERISTICS

WEIGHT- 2900 LBS.
LENGTH- 158.5 IN.
DIAMETER- 18 IN
GUIDANCE- TV/IIR/DATA LINK
CONTROLS- TAIL
AUTOPILOT- PITCH & YAW RATE, ROLL POSITION
PROPULSION- 8-9 IN DIA 120 IN LENGTH, 350 LBS BOOST
WARHEAD- MK-84, IMP MK-84, MK-83
FUZE- FMU-124A/B

PICTORIAL

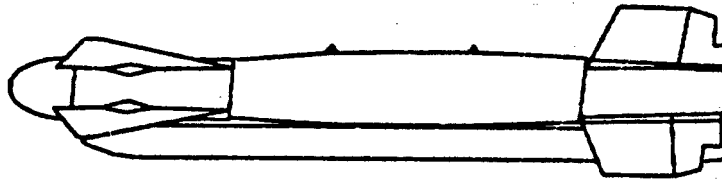

EMPLOYMENT OPTIONS

AIRCRAFT

F-4E (4)
F-111 (4)
F-15 (2)
F-18 (2)

LIMITATIONS

0.55-1.4 MACH BELOW 40 KFT

ENGAGEMENT SYSTEMS

TV, IIR, RADAR DISPLAY
JOY STICK
DATA LINK

LAUNCHER

MAU-12

PROGRAM MANAGEMENT

CONTRACTOR- HUGHES/ROCKWELL
UNIT COST- TBD
STATUS- PRE FSD
NEXT EVENT- FSD JUNE 84
REFERENCE-

TARGETS

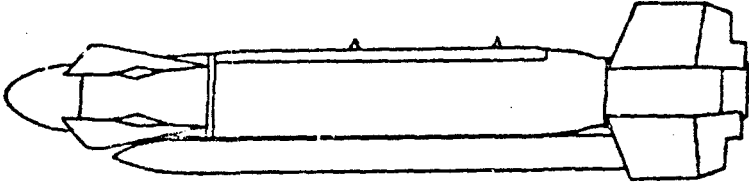
NOMENCLATURE AGM-130B		NAME POWERED CBU-15
WEAPON CHARACTERISTICS		
WEIGHT- 3000 # LENGTH- 160" DIAMETER- 20 25" GUIDANCE- TV/IIR/DATA LINK CONTROLS- TAIL AUTOPILOT- PITCH & YAW, ROLL POSIT PROPULSION- 8-9" DIA, 120" LENGTH, 350# WARHEAD- FUZE- 124A/B MODIFIED		
PICTORIAL		
		
EMPLOYMENT OPTIONS		
AIRCRAFT	SUBMUNITIONS	
F-4E F-15 } ANTICIPATED F-111F A-10 }	BLU-97/B (CEB ~400) BKEP ANTICIP (~400)	
ENGAGEMENT SYSTEMS TV, IIR, & RADAR DISPLAY JOY STICK DATA LINK CONTROL PANEL		
DISPENSER SUU-54A/B		
PROGRAM MANAGEMENT		
CONTRACTOR- G&C HUGHES, CONTROLS ROCKWELL UNIT COST- STATUS- NEXT EVENT- FSED ~ JUN 84 REFERENCE-		

TARGETS . ARMOR/AIRFIELDS

MEDIUM RANGE

NOMENCLATURE

NAME ASSAULT BREAKER

WEAPON CHARACTERISTICS

WEIGHT- 2720 lbs
LENGTH- 254 in
DIAMETER- 16 1/2 in
GUIDANCE- Inertial update from PAVE MOVER
CONTROLS- Tail
AUTOPILOT- 3 axis acc
PROPULSION- TBD
WARHEAD- See submunition
FUZE- See submunition

PICTORIAL

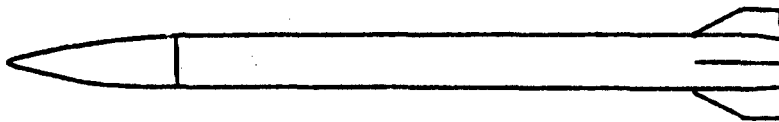

EMPLOYMENT OPTIONS

SUBMUNITIONS

Sheet
TCSM
CADM
CEB
BLU 63
VAM 93

ENGAGEMENT SYSTEMS

Inertial system
PAVE MOVER data link

AIRCRAFT

B-52
F-111 (4)
F-4 (2)
F-16 (2)
A-10 (2)
A-7 (2)

PROGRAM MANAGEMENT

CONTRACTOR- MARJIN MARJETTA
UNIT COSY-
STATUS- TECHNOLOGY TRANSFERED TO JTACMS
NEXT EVENT-
REFERENCE- ESD AV 478-5088 EXT 3875

TARGETS HIGH VALUE FIXED

VERY LONG RANGE

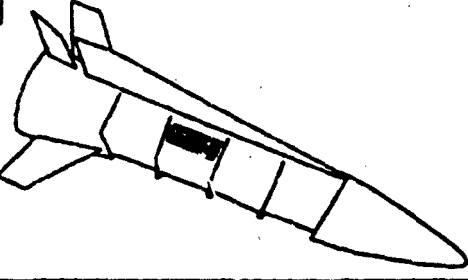
NOMENCLATURE	NAME AXE
WEAPON CHARACTERISTICS WEIGHT- 60,100 LBS LENGTH- 48 FT DIAMETER- TBD GUIDANCE- UPDATED INERTIAL CONTROLS- TAIL AUTOPILOT- 3 AXIS ACCELERATION PROPULSION- TWO STAGE SOLID WARHEAD- SUBMUNITIONS OR UNITARY FUZE- ALTITUDE SENSOR	
PICTORIAL	 <p data-bbox="966 877 1201 952">ONE CONCEPT DESIGN TBD</p>
EMPLOYMENT OPTIONS	
SUBMUNITIONS KEP (384) GATOR	
PROGRAM MANAGEMENT CONTRACTOR- TBD UNIT COST- STATUS- CONCEPT FORMULATION NEXT EVENT- REFERENCE- XRO AV 872-4151	

TARGETS HARD FIXED

LONG RANGE

NOMENCLATURE	NAME BACK BREAKER
--------------	-------------------

WEAPON CHARACTERISTICS

WEIGHT- Depends on submunition (LESS THAN 3000 Lbs)
LENGTH- 232 In
DIAMETER- 20.3 In
GUIDANCE- Inertial update
CONTROLS- Tail
AUTOPILOT- 3 axis acceleration
PROPULSION- Turbojet
WARHEAD- See submunitions below
FUZE- TBD

PICTORIAL

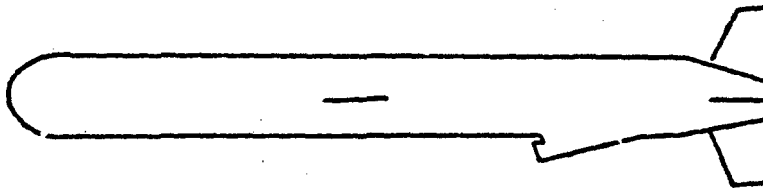

EMPLOYMENT OPTIONS

SUBMUNITIONS

ACM
AMIS
BLU-63
BTM
CADM
CEB
TCSM

ENGAGEMENT SYSTEMS
INERTIAL SYSTEM

AIRCRAFT

B-52
PROGRAM MANAGEMENT

CONTRACTOR-
UNIT COST-
STATUS- ADVANCED DEVELOPMENT COMPLETED
NEXT EVENT-
REFERENCE- MR. GAY AV 872-2838

TARGETS ARMOR

SHORT RANGE

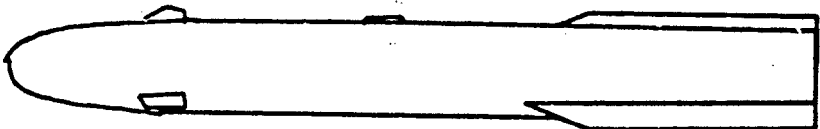
NOMENCLATURE	NAME HELLFIRE
WEAPON CHARACTERISTICS WEIGHT- 90lb LENGTH- 64in DIAMETER- 7in GUIDANCE- LASER CONTROLS- TAIL AUTOPILOT- PITCH/ROLL GYRO PROPULSION- 20,000lb-sec WARHEAD- 20lb SHAPED CHARGE FUZE- CONTACT	
PICTORIAL 	
EMPLOYMENT OPTIONS AIRCRAFT A-10 ATTACK HELICOPTERS LAUNCHER FOUR RAIL UNIQUE DESIGN ENGAGEMENT SYSTEMS LAUNCHER INTERFACE PROGRAM MANAGEMENT CONTRACTOR- ROCKWELL UNIT COST- \$35,000 STATUS- PRODUCTION (ARMY) NEXT EVENT- REFERENCE-	

TARGETS: DEEP STRIKE

LONG RANGE

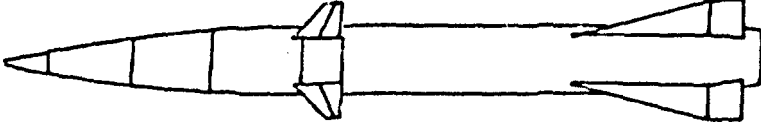
NOMENCLATURE		NAME JTACMS
WEAPON CHARACTERISTICS		
WEIGHT- 3300 LBS LENGTH- 208 in DIAMETER-19 7 in. GUIDANCE-Inertial updated (PLSS & JSTARS) CONTROLS-1a1 AUTOPILOT-3 axis acceleration PROPULSION- TBD (ROCKET OR INTEGRAL ROCKET RAMJET) WARHEAD- See submunitions FUZE- PROGRAMMABLE		
PICTORIAL		
GENERIC SYSTEM		
		
EMPLOYMENT OPTIONS		
SUBMUNITIONS		
TCSM KEP SKEET CEB M-74 MINES UNITARY (1000) CHEMICAL OR NUCLEAR		
LAUNCH VEHICLES		
B-52 G/H F-16 HEMTT TRUCK		
PROGRAM MANAGEMENT		
CONTRACTOR- TBD UNIT COST- STATUS- PRE FSD STUDY NEXT EVENT- FSD 1985 REFERENCE- COL. BARNETT AV 746-1141		

TARGETS SAM SITES

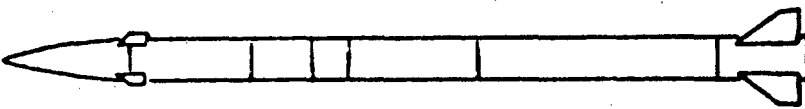
NOMENCLATURE		NAME LSD
WEAPON CHARACTERISTICS		
WEIGHT- 270 LBS LENGTH- 144 IN. DIAMETER-7 IN. GUIDANCE-ARH/MMW CONTROLS-TAIL AUTOPILOT-3 axis acc PROPULSION-BOOST/ LOW SMOKE WARHEAD-25 LBS FUZE- Proximity fuze		
PICTORIAL		
FOLDING FIN OPTION 		
EMPLOYMENT OPTIONS		
AIRCRAFT ATF F-16 F-15 F-111		LIMITATIONS Min. launch alt. 100ft. Max. alt 15000ft. Min launch range 1.5km. Max launch range 30km.
ENGAGEMENT SYSTEMS RVR INERTIAL SENSORS JTIDS GPS/DME		LAUNCHER AMRAAM EJECTOR MODULAR RAIL LAUNCHER
PROGRAM MANAGEMENT CONTRACTOR- UNIT COST- STATUS- NEXT EVENT- REFERENCE-		

TARGETS ARMOR/AIRFIELDS

MEDIUM RANGE

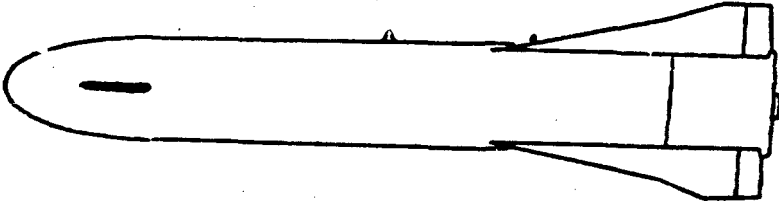
NOMENCLATURE		NAME ADVANCED CLUSTER WEAPON
WEAPON CHARACTERISTICS		(HAMMER) (SAW)
WEIGHT- 3000 Lbs (INCLUDES SUBMUNITIONS) LENGTH- 184 INS DIAMETER-23 x 23 INS GUIDANCE-2-AXIS AUTOPILOT INERTIAL CONTROLS-BANK TO TURN TAIL AUTOPILOT-PREPROGRAMMED PRIOR TO LAUNCH PROPULSION-12,900 lb-sec MOTOR OPTIONAL WARHEAD-MUNITIONS DISPENSER FUZE-S/A FSU 9		
PICTORIAL		
		
EMPLOYMENT OPTIONS		POSSIBLE SUBMUNITIONS
AIRCRAFT F-4 (2) F-15 (2) F-16 (2) F-111 (4) A-10 (2) A-7 (2)		BLU-86 CEB SKEET SADARM SC-357 M-74 STABO HB-876 MUS KB-44 BKEP HTW
ENGAGEMENT SYSTEMS 1760 INTERFACE		
LIMITATIONS MACH 0.4 TO 1.2		
PROGRAM MANAGEMENT CONTRACTOR- UNIT COST- STATUS- CONCEPT DEVELOPMENT NEXT EVENT- FSD 86 REFERENCE-L/C NANCE AV 872-4151		

Handwritten notes on the right margin, including "1" and "10/11/86".

TARGETS: EMITTERS

SHORT RANGE

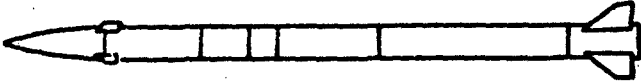
NOMENCLATURE		NAME	SPV
WEAPON CHARACTERISTICS			
WEIGHT-150-200 Lbs			
LENGTH-110-120 In			
DIAMETER-5 In			
GUIDANCE-ARH/Inertial/MMW or IIR			
CONTROLS-Tail or canard			
AUTOPILOT-3 axis acc			
PROPULSION-Boost/low smoke or ducted rocket			
WARHEAD-20-34 Lbs blast frag.			
FUZE-Proximity fuze			
PICTORIAL			
ONE OF FIVE CONCEPTS			
			
EMPLOYMENT OPTIONS			
AIRCRAFT		LIMITATIONS	
A-10		Min launch alt. 100ft	
F-4		Max alt. 15000ft	
F-16		Min launch range 1.5km	
F-15		Max launch range 30km	
F-111			
A-7			
B-52			
ENGAGEMENT SYSTEMS			
RVR			
INERTIAL SENSORS			
JTIDS			
GPS/DME			
PROGRAM MANAGEMENT			
CONTRACTOR-HUGHES, ROCKWELL, TI, CO, MARTIN			
UNIT COST-			
STATUS- TERMINATED 1988 IN CONCEPT DEV			
NEXT EVENT-TECHNOLOGY TRANSFERRED TO SIDEARM II			
REFERENCE-AD/XRC AV 872-3722			

TARGETS HARD FIXED

SHORT RANGE

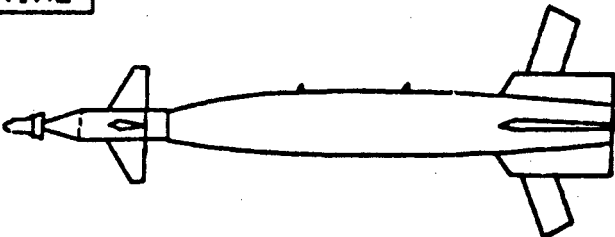
NOMENCLATURE GBU-10C/D		NAME LASER GUIDED BOMB
WEAPON CHARACTERISTICS		
WEIGHT- 2081 LBS LENGTH- 168.9 IN DIAMETER- 18 IN GUIDANCE- Semi-active Laser (1.06 microns) CONTROLS- Canard AUTOPILOT- Proportional PROPULSION- None WARHEAD- MK-84 Bomb FUZE- Selectable see JMEM pg 1061		
PICTORIAL		
		
EMPLOYMENT OPTIONS		
AIRCRAFT		LIMITATIONS
A-7 (2)		MAX VEL. 600 KTAS
F-4 (2-4)		
F-16 (2)		
F-111 (4)		
F-15 (2)		
ENGAGEMENT SYSTEMS		
PAVE TACK LASER DESIGNATOR		
LAUNCHER		
MK 3 MOD 0 LUGS		
PROGRAM MANAGEMENT		
CONTRACTOR- OGDEN AIR LOGISTICS CENTER		
UNIT COST- \$10,000		
STATUS- INVENTORY		
NEXT EVENT-		
REFERENCE- JMEM 1-10		

TARGETS HARD FIXED TARGETS

SHORT RANGE

NOMENCLATURE GBU-12B/B

NAME LASER GUIDED BOMB

WEAPON CHARACTERISTICS

WEIGHT- 600-650 LBS.
LENGTH- 126-131 IN.
DIAMETER- 10 8 IN
GUIDANCE- SEMI-ACTIVE LASER 1 00 MICRONS
CONTROLS- CANARD
AUTOPILOT- ANGLE RATE
PROPULSION- None
WARHEAD- MK-82 BOMB
FUZE- SELECTABLE SEE JMEM

PICTORIAL

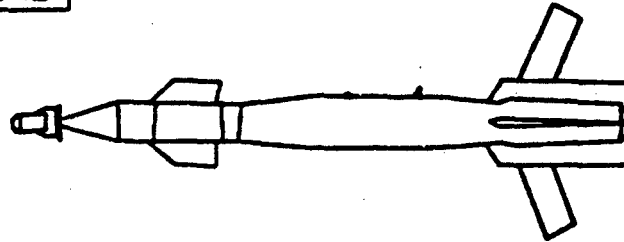

EMPLOYMENT OPTIONS

AIRCRAFT

A-7 (4)
F-4 (2-4)
F-16 (4)
F-111 (4)
F-15 (4)

LIMITATIONS

MAX VELOCITY 600 KTAS

ENGAGEMENT SYSTEMS

PAVE TACK
LASER POD

LAUNCHER

MS3314 LUGS

PROGRAM MANAGEMENT

CONTRACTOR- OGDEN AIR LOGISTICS CENTER
UNIT COST- 68,100
STATUS- INVENTORY
NEXT EVENT-
REFERENCE- JMEM 1-52

TARGETS SHIPS, SAMsites, BRIDGES

MEDIUM RANGE

NOMENCLATURE GBU-15 (V) 1/B NAME:

WEAPON CHARACTERISTICS

WEIGHT-2500 LBS
LENGTH-154.5 In
DIAMETER-18 In
GUIDANCE-TV/DATA LINK
CONTROLS-Tail
AUTOPILOT-Pitch & Yaw rate, Roll position
PROPULSION-None
WARHEAD-MK-84
FUZE-FMU-124A/B

PICTORIAL

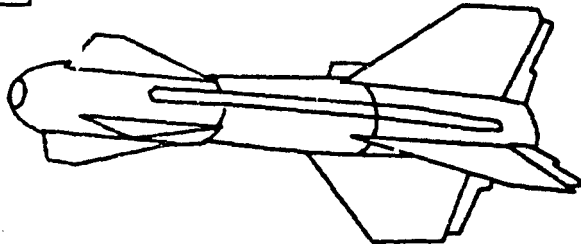

EMPLOYMENT OPTIONS

AIRCRAFT

B-52 (4)
F-4 (2)
F-111 (4)
A-7 (2)

LAUNCHER

MAU-12

LIMITATIONS

SS-1 4 MACH BELOW 40 KFT.

ENGAGEMENT SYSTEM

TV & Radar Display
Joy stick
Data link Control panel

DISPENSER

MK-84

PROGRAM MANAGEMENT

CONTRACTOR-HUGHES/ROCKWELL
UNIT COST-\$131,000
STATUS-INVENTORY
NEXT EVENT-
REFERENCE-MR. PRESCOT 872-4281

TARGETS SHIPS, SAMSITES, BRIDGES

MEDIUM RANGE

NOMENCLATURE CBU-15(V) 2/B

NAME:

WEAPON CHARACTERISTICS

WEIGHT- 2500 LBS

LENGTH- 154.5 In.

DIAMETER- 18 In.

GUIDANCE- IR/Beacon/Data link

CONTROLS- Tail

AUTOPILOT- Pitch & Yaw rate, Roll position

PROPULSION- None

WARHEAD- MK-84

FUZE- FMU-124A/B

PICTORIAL

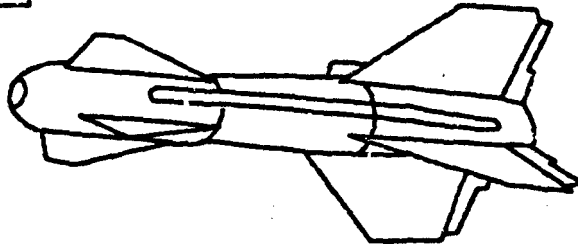

EMPLOYMENT OPTIONS

AIRCRAFT

B-52 (4)

F-4 (2)

F-111 (4)

A-7 (2)

LAUNCHER

MAU-12

LIMITATIONS

.55-1.4 MACH BELOW 40 KFT

ENGAGEMENT SYSTEM

TV & Radar Display

Joy stick

Data link Control panel

DISPENSER

MK-84

PROGRAM MANAGEMENT

CONTRACTOR- HUGHES/ROCKWELL

UNIT COST- \$190,000

STATUS- IOT&E

NEXT EVENT- PRODUCTION DECISION 1985

REFERENCE- CAPT PHILLIPS AV 872-4100

TARGETS PERSONNEL/ARMOR/AIRFIELDS

MEDIUM RANGE

NOMENCLATURE: GBU-15(V) 3/B NAME

WEAPON CHARACTERISTICS

WEIGHT-2050 LBS
LENGTH-154 IN
DIAMETER-20 IN
GUIDANCE- IIR/TV/DATA LINK
CONTROLS- TAIL
AUTOPILOT- PITCH AND YAW RATE, ROLL POSITION
PROPULSION- None
WARHEAD- SUU-54/BLU-63 (CBU-75)
FUZE- FMU-123/B

PICTORIAL

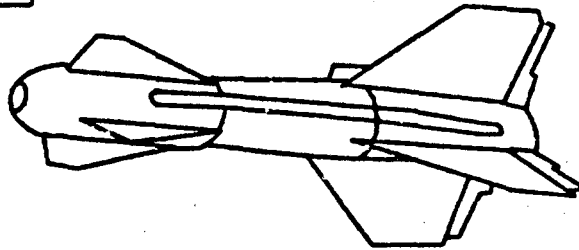

EMPLOYMENT OPTIONS

DISPENSER
SUU-54

SUBUNITIONS

{BLU-63/B (1478)}
{BLU-66/B (370)} CBU-75
BLU-97/B (415)
BLU-91/B (178)
BLU-92/B (178)
BKEP (35)

PROGRAM MANAGEMENT

CONTRACTOR-HUGHES/ROCKWELL
UNIT COST-TBD
STATUS-PRODUCTION DECISION?
NEXT EVENT-
REFERENCE-MR. PRESCOTT 972-4261

TARGETS HARD FIXED

MEDIUM RANGE

NOMENCLATURE CBU-20(V) 2/B NAME:

WEAPON CHARACTERISTICS

WEIGHT-2700-3025 Lbs
LENGTH-154.5 In.
DIAMETER-32 In.
GUIDANCE-IR/Beacon/Data link
CONTROLS-Tail
AUTOPILOT- Pitch & Yaw rate, Roll position
PROPULSION-None
WARHEAD-BLU-63
FUZE-FMU-124A/B

PICTORIAL

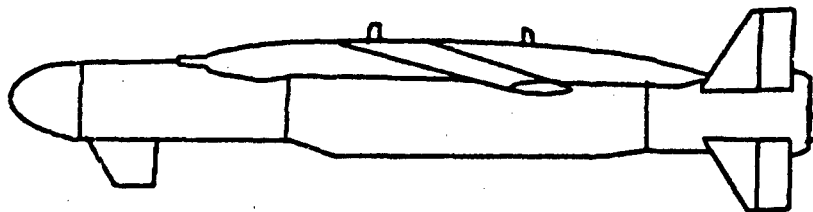

EMPLOYMENT OPTIONS

AIRCRAFT
B-52

LAUNCHER
MAU-12 on heavy stores adapter

ENGAGEMENT SYSTEM
TV & Radar display
Joy stick & Data link

DISPENSER
SUU-54

PROGRAM MANAGEMENT
CONTRACTOR- HUGHES/ROCKWELL
UNIT COST-
STATUS- VALIDATION COMPLETE
NEXT EVENT-TERMINATED
REFERENCE-MR. PRESCOTT AV 872-4261

TARGETS HARD FIXED TARGETS

SHORT RANGE

NOMENCLATURE GBU-22

NAME LLLGB MK-82

WEAPON CHARACTERISTICS

WEIGHT-800 Lbs.
LENGTH-132 In.
DIAMETER-10 In.
GUIDANCE-Laser semi-active
CONTROLS-Nose canards
AUTOPILOT-Proportional guidance
PROPULSION-None
WARHEAD-MK-82
FUZE-Contact

PICTORIAL

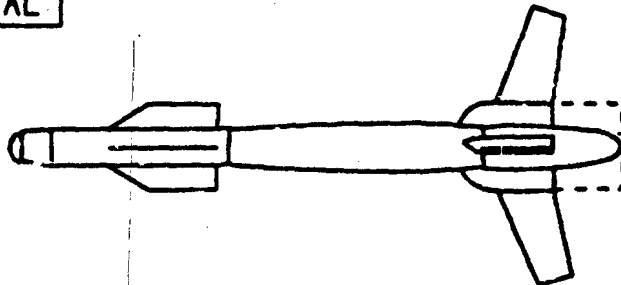

EMPLOYMENT OPTIONS

AIRCRAFT

F-4 (4)
F-111 (8)
A-10
A-7 (4)
F-16 (4)

LAUNCHER

MAU-12
BRU-3
TER
MER

ENGAGEMENT SYSTEMS

Laser designator

LIMITATIONS

300 KTAS TO 1.4M

PROGRAM MANAGEMENT

CONTRACTOR-TEXAS INST.
UNIT COST-\$14,502 FY83
STATUS-PRODUCTION
NEXT EVENT-
REFERENCE-MR. FUNK 072-2533

TARGETS HARD FIXED TARGETS

SHORT RANGE

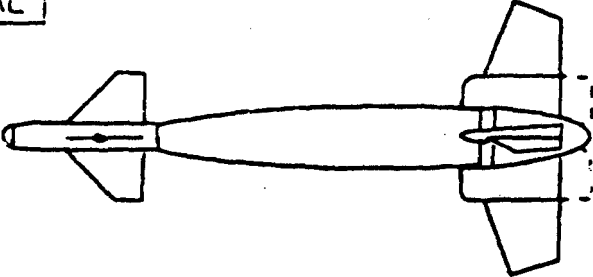
NOMENCLATURE GBU-24		NAME LLLGB MK-84
WEAPON CHARACTERISTICS		
WEIGHT-2267 Lbs LENGTH-169 In DIAMETER-18 In GUIDANCE-Laser semi-active CONTROLS-Nose canards AUTOPILOT-Proportional guidance PROPULSION-None WARHEAD-MK-84 FUZE-FMU-81/112		
PICTORIAL		
		
EMPLOYMENT OPTIONS		
AIRCRAFT F-4 (2) F-111 (4) A-7 (2) F-16 (2)	LAUNCHER MAU-12 BRU-3 TER MER	
ENGAGEMENT SYSTEMS Laser designator		
LIMITATIONS 300 KTAS TO 1 4M launch		
PROGRAM MANAGEMENT CONTRACTOR-TEXAS INST. UNIT COST-\$14,935 FY83 STATUS-PRODUCTION NEXT EVENT- REFERENCE-MR FUNK 872-2533		

TARGETS HARD FIXED

MEDIUM RANGE

NOMENCLATURE

NAME HTW

WEAPON CHARACTERISTICS

WEIGHT- 2000 - 3000 LBS
LENGTH- 155 IN
DIAMETER- 18 IN
GUIDANCE- INERTIAL/INERTIAL UPDATED/CORRELATION
CONTROLS- TAIL
AUTOPILOT- TBD
PROPULSION- BOOST
WARHEAD- PENETRATOR (BTM, 2000 LBS , ETC.)
FUZE- VOID SENSING OR TIME DELAY OR IMPACT ETC

PICTORIAL

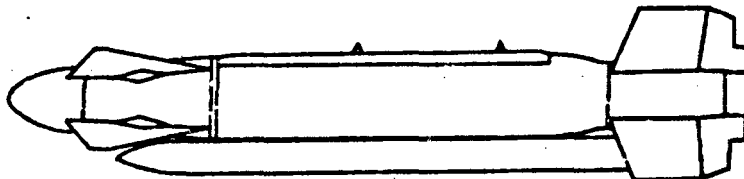

ONE OF MANY POSSIBLE CONFIGURATIONS

EMPLOYMENT OPTIONS

AIRCRAFT

B-52 (4)
F-4 (2)
F-111 (4)
A-7 (2)
F-16 (2)

ENGAGEMENT SYSTEMS

CPS
PLSS
INERTIAL

PROGRAM MANAGEMENT

CONTRACTOR- BOM STUDY PHASE
UNIT COST-
STATUS- CONCEPT STUDIES
NEXT EVENT- CONCEPT DEFINITION 1988
REFERENCE- MR TODD AV 872-4151

TARGETS HARD FIXED TARGETS

SHORT RANGE

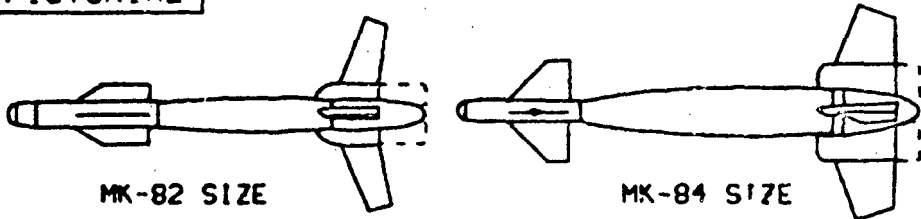
NOMENCLATURE		NAME LLGB
WEAPON CHARACTERISTICS		LAUNCH & LEAVE GUIDED BOMB
WEIGHT- 730 OR 2200 LBS LENGTH- 132 OR 169 IN DIAMETER- 10 OR 18 IN GUIDANCE- IMAGING INFRARED (LWIR) CONTROLS- CANARD AUTOPILOT- ANGLE RATE PROPULSION- None WARHEAD- MK-82 OR MK-84 FUZE- FMU-81, FMU-112, MK905		
PICTORIAL		
		
SUU-64 VERSIONS ALSO CONSIDERED		
EMPLOYMENT OPTIONS		
AIRCRAFT		LIMITATIONS
F-4 (2-4) F-111 (4-8) A-7 (2-4) F-16 (2-4)		300 KTAS TO 1.4 MACH
ENGAGEMENT SYSTEMS BOMBING COMPUTER		
LAUNCHER MAU-12 BRU-3 TER/MER		
PROGRAM MANAGEMENT CONTRACTOR- TEXAS INSTRUMENTS (SEEKER DEV (RHVTA) UNIT COST -> \$20,000 STATUS- ADVANCED DEVELOPMENT NEXT EVENT- FSD 1688 REFERENCE- MAJ MARTINDALEAV 872-4830		

**UNGUIDED
WEAPONS**



vii

[Faint vertical text on the right margin, possibly bleed-through from the reverse side of the page.]

[Faint horizontal text at the bottom of the page, possibly bleed-through from the reverse side.]

TARGETS HARD AREA TARGETS

SHORT RANGE

NOMENCLATURE MK 20		NAME ROCKEYE II
WEAPON CHARACTERISTICS		
WEIGHT-500 LBS LENGTH-92 INCH DIAMETER-13.2 INCH GUIDANCE-UNGUIDED CONTROLS-NONE AUTOPILOT-NONE PROPULSION-NONE WARHEAD-217 MK-118 SHAPED CHARGE SUBMUNITIONS FUZE-CONTACT MK 1 MOD 0 FOR SUBMUNITION MK 339 MOD 0 TIME FUZE FOR DISPENSER		
PICTORIAL		
 MK 7 MOD 2 DISPENSER		 MK 118 MOD 0 BOMBS
EMPLOYMENT OPTIONS		
AIRCRAFT F-4 (4-8) F-15 (8) F-16 (4) A-7 (6) A-10 (6) F-111 (8)	LAUNCHER PYLON MOUNTED	LIMITATIONS MAX CARRAGE MACH 1.37 @ 8000 KCAS DELIVERY 225-500 KCAS MIN ALT REL 500 FT AGL OR 400 FT AGL WITH 4G ESCAPE
DISPENSER MK 7		
PROGRAM MANAGEMENT CONTRACTOR- UNIT COST- \$3820 STATUS- INVENTORY NEXT EVENT- REFERENCE- JMEM 8-78		

TARGETS FIXED

SHORT RANGE

NOMENCLATURE MK-82	NAME GP BOMB
--------------------	--------------

WEAPON CHARACTERISTICS

WEIGHT- 531 LBS
LENGTH- 90 IN
DIAMETER- 10 8 IN
GUIDANCE- None
CONTROLS- None
AUTOPILOT- None
PROPULSION- None
WARHEAD- Blast frag 502 Lbs
FUZE Mechanical or electrical (FMU-130)

PICTORIAL

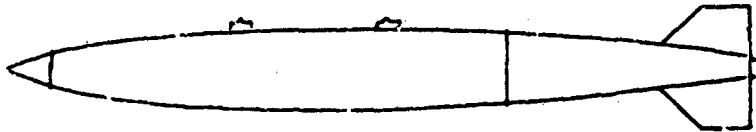

EMPLOYMENT OPTIONS

AIRCRAFT

F-4 (4-6)
F-16 (4)
A-10 (6)
F-111 (12)
A-7 (8)
F-15 (4-8)

LIMITATIONS

MAX VEL 500KIAS

ENGAGEMENT SYSTEMS
BOMBING COMPUTER

LAUNCHER

MS3314 LUGS
PROGRAM MANAGEMENT
CONTRACTOR-
UNIT COST- \$797
STATUS- INVENTORY
NEXT EVENT-
REFERENCE- JMEM 1-10

TARGETS HARD FIXED

SHORT RANGE

NOMENCLATURE MK-82 (BSU-49) NAME GP BOMB

WEAPON CHARACTERISTICS

WEIGHT-540 LBS.
LENGTH-90 IN
DIAMETER-10 8 IN
GUIDANCE-None
CONTROLS-None
AUTOPILOT-None
PROPULSION-None
WARHEAD-502 LBS Blast Frog
FUZE- Contact FHU-112

PICTORIAL

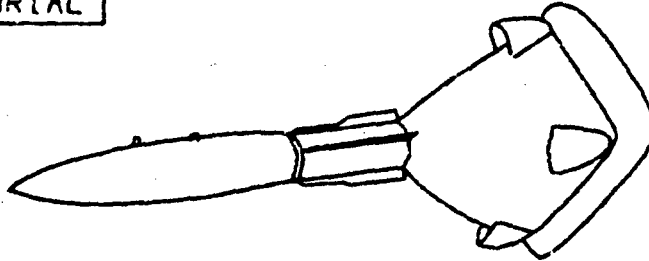

EMPLOYMENT OPTIONS

AIRCRAFT

A-10 (6)
A-7 (6)
F-4 (4)
F-16 (4)
F-111 (12)
F-15 (8)

LIMITATIONS

MAX VEL 700 KIAS

ENGAGEMENT SYSTEMS

BOMBING COMPUTER

PROGRAM MANAGEMENT

CONTRACTOR-
UNIT COST- \$2105
STATUS- INVENTORY
NEXT EVENT-
REFERENCE- JMEM 1-14C

TARGETS HARD FIXED

SHORT RANGE

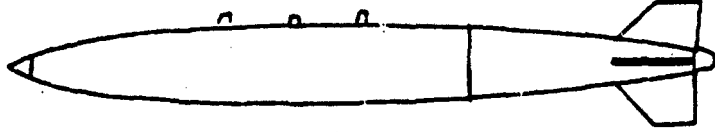
NOMENCLATURE MK-84		NAME GP BOMB
WEAPON CHARACTERISTICS		
WEIGHT-1972 Lbs. LENGTH-154 IN DIAMETER-18 In GUIDANCE-None CONTROLS-None AUTOPILOT-None PROPULSION-None WARHEAD- Blast Fragmentation FUZE- Contact FMU-130		
PICTORIAL		
		
EMPLOYMENT OPTIONS		
AIRCRAFT A-7 (2) F-4 (2) F-16 (2) F-111 (4) F-15 (3)	LIMITATIONS 600 KIAS	
ENGAGEMENT SYSTEMS Bombing computer		
LAUNCHER MK 3 MOD 0 LUGS		
PROGRAM MANAGEMENT CONTRACTOR- UNIT COST- \$2400 STATUS-INVENTORY NEXT EVENT- REFERENCE- JMEM 1-24		

TARGETS HARD FIXED

SHORT RANGE

NOMENCLATURE MK-84 (BSU-50) NAME CP BOMB

WEAPON CHARACTERISTICS

WEIGHT- 2016 LBS.
LENGTH- 15 IN
DIAMETER- 10 IN
GUIDANCE- None
CONTROLS- None
AUTOPILOT- None
PROPULSION- None
WARHEAD- Blast Frog
FUZE- Contact FMU-112

PICTORIAL

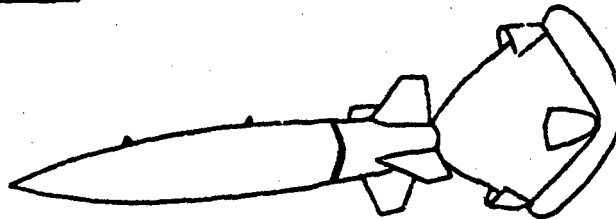

EMPLOYMENT OPTIONS

AIRCRAFT

A-7 (2)
F-4 (2)
F-16 (2)
F-111 (4)
F-15 (3)

LIMITATIONS

MAX VEL 700 KIAS

ENGAGEMENT SYSTEMS
BOMBING COMPUTER

PROGRAM MANAGEMENT

CONTRACTOR-
UNIT COST- \$3003
STATUS- PRODUCTION
NEXT EVENT-
REFERENCE- JMEM 1-28A

TARGETS: SOFT AND HARD FIXED

SHORT RANGE

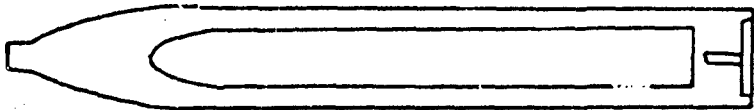
NOMENCLATURE		NAME IMPROVED 2000
WEAPON CHARACTERISTICS		(IMPROVED MK-84)
WEIGHT-1928 LBS. LENGTH-100 IN DIAMETER- 14.5 IN. GUIDANCE- CONTROLS- AUTOPILOT- PROPULSION- WARHEAD- FUZE-FMU-112, FMU-139, FMU-124, MOD FUZE		
INTEGRATED INTO GBU-15 AND GBU-24		
PICTORIAL		
		
EMPLOYMENT OPTIONS		
AIRCRAFT	LAUNCHER	
A-7 (2)	MAU-12	
F-16 (2)	MER/TER	
F-111 (4)		
F-4 (2)		
ENGAGEMENT SYSTEMS		
SAME AS GBU-15 OR LLLGB		
LIMITATIONS		
300 KTAS TO 1.4 M LAUNCH		
PROGRAM MANAGEMENT		
CONTRACTOR-		
UNIT COST-98-10K		
STATUS- ADV DEV		
NEXT EVENT-FSD		
REFERENCE- DR. CALUDA AV0725375		

TARGETS HARD FIXED

SHORT RANGE

NOMENCLATURE M117 RETARD

NAME: GP BOMB

WEAPON CHARACTERISTICS

WEIGHT- 954 LBS.
LENGTH- 82 IN.
DIAMETER- 18 1 IN.
GUIDANCE- None
CONTROLS- None
AUTOPILOT- None
PROPULSION- None
WARHEAD- BLAST FRAGMENTATION 754 LBS. HE
FUZE- CONTACT

PICTORIAL

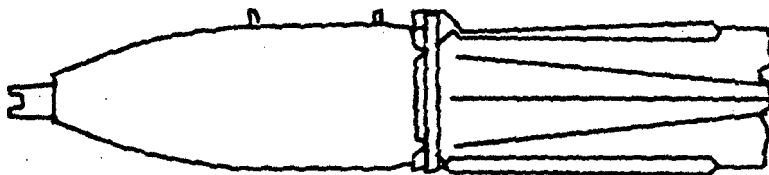

EMPLOYMENT OPTIONS

AIRCRAFT

F-4 (4)
F-16 (4)
F-15 (4)
A-7 (4)
F-111 (8)

LIMITATIONS

600 KAIS

ENGAGEMENT SYSTEMS
BOMBING COMPUTER

LAUNCHER
MS 3314 LUGS

PROGRAM MANAGEMENT
CONTRACTOR- OGDEN AIR LOGISTICS CENTER
UNIT COST-
STATUS- INVENTORY
NEXT EVENT-
REFERENCE- JMEM 1-22

TARGETS: HARD FIXED

SHORT RANGE

NOMENCLATURE: N118

NAME: DEMOLITION BOMB

WEAPON CHARACTERISTICS

WEIGHT- 3020 LBS
LENGTH- 183 IN
DIAMETER- 24 1 IN
GUIDANCE- None
CONTROLS- None
AUTOPILOT- None
PROPULSION- None
WARHEAD- BLAST 188 LBS HE
FUZE- CONTACT

PICTORIAL

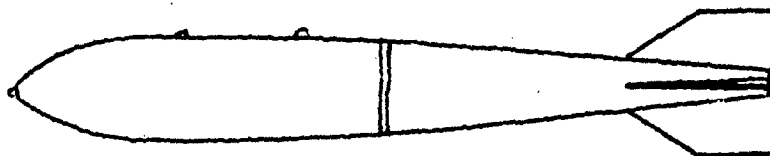

EMPLOYMENT OPTIONS

AIRCRAFT

F-4 (2)
F-111 (4)

LIMITATIONS

600 KIAS

ENGAGEMENT SYSTEMS

BOMBING COMPUTER

LAUNCHER

MK 3 MOD 0 LUGS

PROGRAM MANAGEMENT

CONTRACTOR- AFLC OGDEN AIR LOGISTICS CTR

UNIT COST-

STATUS- INVENTORY

NEXT EVENT-

REFERENCE- JMEM 1-34

TARGETS PERSONAL/MATERIAL

SHORT RANGE

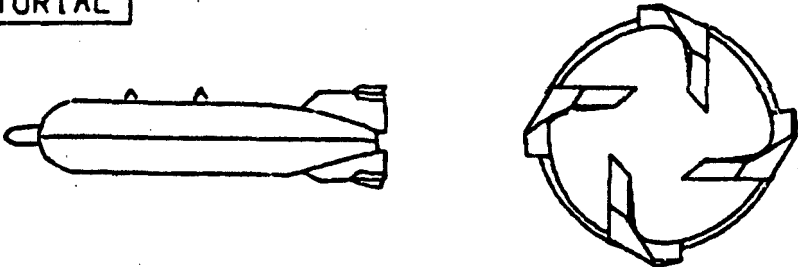
NOMENCLATURE CBU-52 /BLU-61		NAME
WEAPON CHARACTERISTICS		
WEIGHT- 789 LBS LENGTH- 93 IN DIAMETER- 16 IN GUIDANCE- None CONTROLS- None AUTOPILOT- None PROPULSION- None WARHEAD- 220 BLU-61A/B BOMBLETS FUZE- M339 Dispenser , M219 Bomblet		
PICTORIAL		
		
EMPLOYMENT OPTIONS		
AIRCRAFT A-7 (8) F-4 (4-8) F-16 (4) F-111 (8) F-15 (8)	LIMITATIONS MAX VEL 625 KIAS	DISPENSER SUU-308/B
ENGAGEMENT SYSTEMS BOMBING COMPUTER	SUBMUNITION 220 BLU-61A/B	
PROGRAM MANAGEMENT CONTRACTOR- USA UNIT COST- \$1800 STATUS- INVENTORY NEXT EVENT- REFERENCE- JMEM 8-44		

TARGETS LIGHT MATERIAL

SHORT RANGE

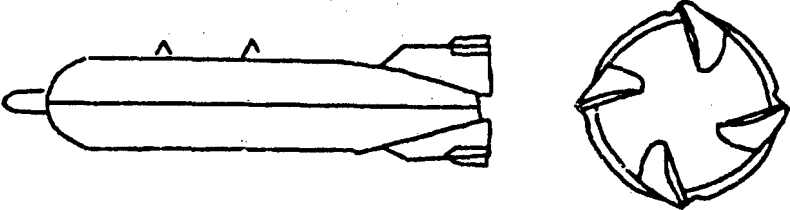
NOMENCLATURE CBU-58		NAME
WEAPON CHARACTERISTICS		
WEIGHT- 800 LBS LENGTH- 93 IN DIAMETER- 18 IN GUIDANCE- None CONTROLS- None AUTOPILOT- None PROPULSION- None WARHEAD- 650 BLU-63 Bomblets FUZE- M339 Dispenser, M219 Bomblet		
PICTORIAL		
		
EMPLOYMENT OPTIONS		
AIRCRAFT	LIMITATIONS	
A-7 (8)	MAX VEL. 625 KIAS	
F-4 (4-8)		
F-16 (4)		
F-111 (8)	DISPENSER	
F-15 (8)	SUU-30H/B	
ENGAGEMENT SYSTEMS	SUBMUNITION	
BOMBING COMPUTER	650 BLU-63/B	
LAUNCHER		
14 INCH BOMB RACKS		
PROGRAM MANAGEMENT		
CONTRACTOR- USA		
UNIT COST- \$3124		
STATUS- INVENTORY		
NEXT EVENT-		
REFERENCE- JMEM 6-88		

TARGETS HARD AREA TARGETS

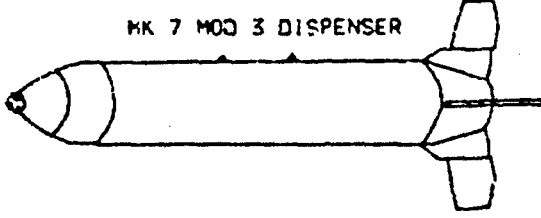
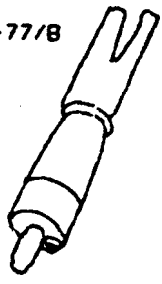
NOMENCLATURE CBU-59/B		NAME APAM
WEAPON CHARACTERISTICS		
WEIGHT- 750 LBS LENGTH- 92 INCH DIAMETER- 13 2 INCH GUIDANCE--UNGUIDED CONTROLS-NONE AUTOPILOT-NONE PROPULSION-NONE WARHEAD- 717 BLU-77/B SHAPED CHARGE FUZE- CONTACT MK 1 MOD 0 FOR SUBMUNITION MK 339 MOD 0 TIME FUZE FOR DISPENSER		
PICTORIAL		
MK 7 MOD 3 DISPENSER 	BLU-77/B 	
EMPLOYMENT OPTIONS		
AIRCRAFT F-4 (4-8) F-15 (8) F-16 (4) A-7 (8) A-10 (6) F-111 (8)	LAUNCHER PYLON MOUNTED	DISPENSER MK 7
PROGRAM MANAGEMENT CONTRACTOR-USA UNIT COST- STATUS- INVENTORY NEXT EVENT- REFERENCE- JMEM 8-83	LIMITATIONS MAX CARRAGE MACH 1.3/700 KCAS DELIVERY 225-500 KCAS MIN ALT REL 500 FT AGL OR 400 FT. AGL WITH 4G ESCAPE	SUBMUNITION BLU-77/B (717)

TARGETS:

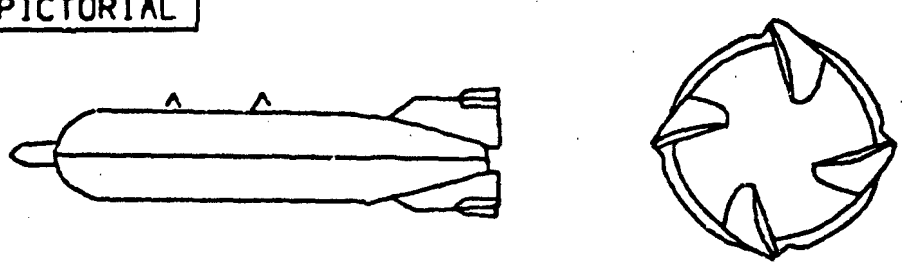
NOMENCLATURE CBU-71/B	NAME				
WEAPON CHARACTERISTICS WEIGHT- 789 LBS LENGTH- 93 IN DIAMETER- 16 IN GUIDANCE- None CONTROLS- None AUTOPILOT- None PROPULSION- None WARHEAD- 650 BLU-86 TIME DELAY BOMBLETS FUZE- M339 Dispenser, M219 Bomblet					
PICTORIAL 					
EMPLOYMENT OPTIONS <table border="0"> <tr> <td data-bbox="273 1113 785 1310"> AIRCRAFT A-7 (8) F-4 (4-8) F-16 (4) F-111 (8) F-15 (8) </td> <td data-bbox="785 1113 1216 1201"> LIMITATIONS MAX VEL 625 KIAS </td> </tr> <tr> <td data-bbox="273 1375 785 1642"> ENGAGEMENT SYSTEMS BOMBING COMPUTER LAUNCHER 14 INCH BOMB RACKS PROGRAM MANAGEMENT CONTRACTOR- USA UNIT COST- \$3824 STATUS- NEXT EVENT- REFERENCE- JMEM 6-71 </td> <td data-bbox="785 1223 1216 1419"> DISPENSER SUU-304/B SUBMUNITION 650 BLU-86/B </td> </tr> </table>		AIRCRAFT A-7 (8) F-4 (4-8) F-16 (4) F-111 (8) F-15 (8)	LIMITATIONS MAX VEL 625 KIAS	ENGAGEMENT SYSTEMS BOMBING COMPUTER LAUNCHER 14 INCH BOMB RACKS PROGRAM MANAGEMENT CONTRACTOR- USA UNIT COST- \$3824 STATUS- NEXT EVENT- REFERENCE- JMEM 6-71	DISPENSER SUU-304/B SUBMUNITION 650 BLU-86/B
AIRCRAFT A-7 (8) F-4 (4-8) F-16 (4) F-111 (8) F-15 (8)	LIMITATIONS MAX VEL 625 KIAS				
ENGAGEMENT SYSTEMS BOMBING COMPUTER LAUNCHER 14 INCH BOMB RACKS PROGRAM MANAGEMENT CONTRACTOR- USA UNIT COST- \$3824 STATUS- NEXT EVENT- REFERENCE- JMEM 6-71	DISPENSER SUU-304/B SUBMUNITION 650 BLU-86/B				

TARGETS AREA TARGETS

SHORT RANGE

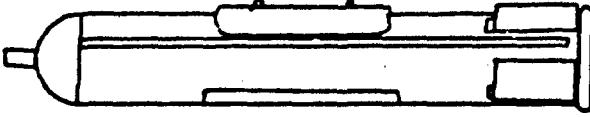
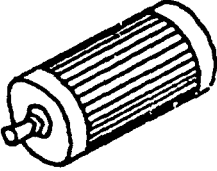
NOMENCLATURE CBU-72/B		NAME FUEL AIR EXPLOSIVE
WEAPON CHARACTERISTICS		
WEIGHT- 500 LBS. LENGTH- 85 6 IN DIAMETER- 14 IN GUIDANCE- None CONTROLS- None AUTOPILOT- None PROPULSION- None WARHEAD- BLU-73/B (FUEL) FUZE-MK 338 MOD 0 MECHANICAL		
PICTORIAL		
		
SUU-49/B		BLU-73/B
EMPLOYMENT OPTIONS		
DISPENSER SUU-49/B		
SUBMUNITIONS BLU-73/B (3)		
PROGRAM MANAGEMENT CONTRACTOR- USA UNIT COST- STATUS- NEXT EVENT- REFERENCE-JMEM 1-44A		

TARGETS

NOMENCLATURE CBU-87/B		NAME CEM
WEAPON CHARACTERISTICS		
WEIGHT- 945 lbs. LENGTH- 92 INS DIAMETER-15 8 ins GUIDANCE-N/A CONTROLS-SPIN AUTOPILOT-NONE PROPULSION-NONE WARHEAD-CEB BLU 97/B shaped charge/ fragmentation FUZE- INTEGRAL PART OF DISPENSER & INCENDIARY FZU-39/B PROX SENSOR		
PICTORIAL		
EMPLOYMENT OPTIONS		
AIRCRAFT	DISPENSER	
F-4 (6)	SUU-65/A	
F-16 (4)	SUBMUNITIONS	
A-10 (4)	CEB/BLU-97/B (202)	
F-111 (8)		
A-7 (4)	ENGAGEMENT SYSTEMS	
	None	
LIMITATIONS		
A/C LAUNCH ENV		
LAUNCHER MER/TER		
PROGRAM MANAGEMENT		
CONTRACTOR-AERO JET GENERAL		
UNIT COST-\$13,500		
STATUS-		
NEXT EVENT-		
REFERENCE- S08M MR. BROWN AV 8723000		

TARGETS

NOMENCLATURE CBU-89/B		NAME GATOR
WEAPON CHARACTERISTICS		
WEIGHT-710 lb LENGTH-92 in DIAMETER-16 in GUIDANCE-None CONTROLS-None AUTOPILOT-none PROPULSION-none WARHEAD-BLU 91/92 FUZE- INTEGRAL PART OF DISPENSER FZU-39/B PROX SENSOR		
PICTORIAL		
EMPLOYMENT OPTIONS		
AIRCRAFT	DISPENSER	
F-16 (4)	SUU-84/B	
F-111 (8)		
A-10 (4)	SUBMUNITION	
F-4 (8)	BLU-91/B (72) ANTI-TANK	
ENGAGEMENT SYSTEMS	BLU-92/B (22) ANTI-PERSONNEL	
NONE		
LIMITATIONS	LAUNCHER	
DELIVERY ENVELOPE	MER/TER	
200 ft TO 40,000 ft ALT		
200 TO 700 KNOTS A/S		
PROGRAM MANAGEMENT		
CONTRACTOR-HONEYWELL/AEROJET		
UNIT COST-\$25,800		
STATUS-		
NEXT EVENT-		
REFERENCE-VALADE AV8723000		

TARGETS HEAVY ARMOR

NOMENCLATURE	CBU-90/B	NAME	ACM
WEAPON CHARACTERISTICS			
WEIGHT- 945 lbs LENGTH- 92 ins DIAMETER-15 8 ins GUIDANCE-N/A CONTROLS-Spin Option AUTOPILOT- N/A PROPULSION-N/A WARHEAD- BLU-99(ACM) {3 horizontal and 1 downward slug {Self forging fragmenting FUZE- Integral part of Dispenser FZU-39/B Prox Sensor			
PICTORIAL			
EMPLOYMENT OPTIONS			
AIRCRAFT		SUBMUNITION	
F-4	(6)	BLU-99	(48)
F-16	(4)	DISPENSER	
F-111	(8)	SUU-65/B	
A-10	(4)		
A-7	(4)		
ENGAGEMENT SYSTEMS			
COCKPIT ARMING			
LAUNCHER			
MER/TER			
PROGRAM MANAGEMENT			
CONTRACTOR- HONEYWELL			
UNIT COST- \$27,000 FY82*			
STATUS-TERMINATED AFTER FSD			
NEXT EVENT-			
REFERENCE-			

TARGETS:

NOMENCLATURE: CBU-92/B		NAME	ERAM
WEAPON CHARACTERISTICS			
WEIGHT- 960 lb			
LENGTH- 92 in			
DIAMETER- 15.6 in			
GUIDANCE- N/A			
CONTROLS- SPIN CONTROL			
AUTOPILOT- N/A			
PROPULSION- N/A			
WARHEAD- SELF FORCING FRAG BLU-101/B			
FUZE- FZU-39/B Proximity sensor			
PICTORIAL			
EMPLOYMENT OPTIONS			
AIRCRAFT		SUBMUNITIONS	
F-4 (6)		BLU-101B AVCO (9)	
F-16 (4)			
F-111 (8)			
A-10 (4)		DISPENSER	
ENGAGEMENT SYSTEM		SUU-65/B	
ARMING			
LAUNCHER			
MER/TER			
LIMITATIONS A/C LAUNCH ENV			
PROGRAM MANAGEMENT			
CONTRACTOR- AVCO			
UNIT COST- \$37,500			
STATUS- VALIDATION COMPLETE			
NEXT EVENT- FSD 85			
REFERENCE- MR HILL AV 8725780			

TARGETS AIRFIELDS

NOMENCLATURE		NAME DURANDAL
WEAPON CHARACTERISTICS		
WEIGHT- 430 LBS. LENGTH- 96 IN DIAMETER- 9 IN GUIDANCE- None CONTROLS- Parachute resist AUTOPILOT- None PROPULSION- Boost only WARHEAD- Blast FUZE- Contact delay		
PICTORIAL		
EMPLOYMENT OPTIONS		
AIRCRAFT F-4 (4-8) F-16 (4) F-111 (12) F-15 (8)		LIMITATIONS 500 KTAS ON F-111 630 KTAS ON F-4
ENGAGEMENT SYSTEMS BOMBING COMPUTER		
LAUNCHER 14 INCH RACKS		
PROGRAM MANAGEMENT CONTRACTOR- FRANCE UNIT COST- \$25,000 STATUS- NEXT EVENT- REFERENCE- LT COL PEARCE AV 8728557		

TARGETS: LIGHT ARMOR

NOMENCLATURE GPU-5A	NAME 30 MM GUN POD
---------------------	--------------------

WEAPON CHARACTERISTICS

WEIGHT- 2000 lbs
LENGTH- 14 ft
DIAMETER- 25.12 ins
GUIDANCE- NA
CONTROLS- NA
AUTOPILOT- NA
PROPULSION- NA
WARHEAD- 30 mm ammo
FUZE- NA

PICTORIAL



EMPLOYMENT OPTIONS

AIRCRAFT

F-4 (2)
A-7 (2)
F-16 (2)

ENGAGEMENT SYSTEM

A/C radar

LIMITATIONS

No maneuvering restrictions

LAUNCHER

PYLON MOUNTED

PROGRAM MANAGEMENT

CONTRACTOR- GENERAL ELECTRIC
UNIT COST- \$311,500
STATUS- PRODUCTION
NEXT EVENT-
REFERENCE- MAJ. FRANCIS AV8728186

TARGETS TANK VEHICLES

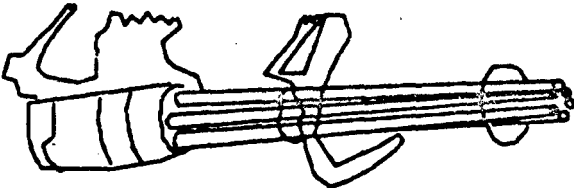
NOMENCLATURE	NAME STABILIZED GAU-8
<p>WEAPON CHARACTERISTICS</p> <p>WEIGHT-Increase GAU-8 by 300 Lbs LENGTH-N/A DIAMETER-30 mm. GUIDANCE-Lantern pod used for LOS CONTROLS-Hydraulic actuators AUTOPILOT-N/A PROPULSION-N/A WARHEAD-Discarding SABOT improved API FUZE- N/A</p>	
<p>PICTORIAL</p> 	
<p>EMPLOYMENT OPTIONS</p> <p>AIRCRAFT A-10 (1)</p> <p>ENGAGEMENT SYSTEM LANTIRN POD INS</p> <p>LIMITATIONS A-10 ENVELOPE</p> <p>PROGRAM MANAGEMENT CONTRACTOR- FRAICILD UNIT COST- STATUS- TERMINATED 82 NEXT EVENT- REFERENCE-</p>	

TARGETS AREA TARGETS

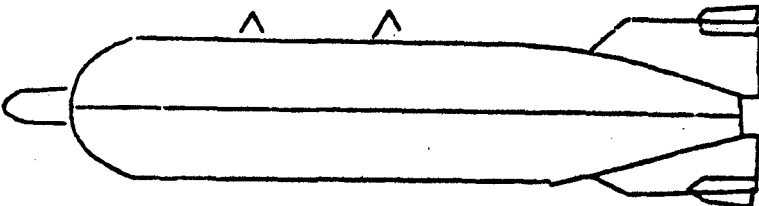
NOMENCLATURE SUU-30A/B		NAME DISPENSER
WEAPON CHARACTERISTICS		
WEIGHT- 195 LBS EMPTY 830 LBS LOADED WITH BLU-28/B		
LENGTH- 93 IN		
DIAMETER- 16 IN		
GUIDANCE- None		
CONTROLS- None		
AUTOPILOT- None		
PROPULSION- None		
WARHEAD- SEE SUBMUNITIONS		
FUZE-		
PICTORIAL		
		
EMPLOYMENT OPTIONS		
SUBMUNITIONS		SYSTEM
BLU-28/B	(650-670)	CBU-24
BLU-61/B	(220)	CBU-52
BLU-63/B	(650)	CBU-58
BLU-85/B	(70)	CBU-70
PROGRAM MANAGEMENT		
CONTRACTOR- USA		
UNIT COST-		
STATUS- INVENTORY		
NEXT EVENT-		
REFERENCE- JMEM 6-31		

TARGETS . ARMOR . AREA

SHORT RANGE

NOMENCLATURE SUU-54	NAME .
---------------------	--------

WEAPON CHARACTERISTICS

WEIGHT- 2140 LBS LOADED
LENGTH- 137 IN
DIAMETER- 20 IN
GUIDANCE- None
CONTROLS- None
AUTOPILOT- None
PROPULSION- None
WARHEAD- SEE SUBUNITIONS
FUZE- FMU-110/B

PICTORIAL

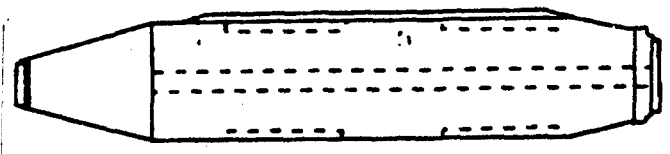

EMPLOYMENT OPTIONS

AIRCRAFT

- C-111 (4)
- F-4 (2)
- F-16 (2)
- A-7 (2)

SUBUNITIONS

- | | | | |
|-----------------|---|---|---------------|
| BLU-83/B (1440) | } | { | CBU-75/B |
| BLU-86/B (360) | | | CBU-15(V) 3/B |
| BLU-61A/B (650) | | | CBU-70/B |
| BLU-87/B (90) | | | CBU-80/B |
| BLU-100 (35) | } | | |
| BLU-91/92 (170) | | | |
| BLU-97/B (15) | | | CBU-15(V) 3/B |

PROGRAM MANAGEMENT

CONTRACTOR-
UNIT COST-
STATUS- INVENTORY
NEXT EVENT-
REFERENCE- MR. PRESCOTT AV 872-4621

TARGETS ARMOR, AREA

SHORT RANGE

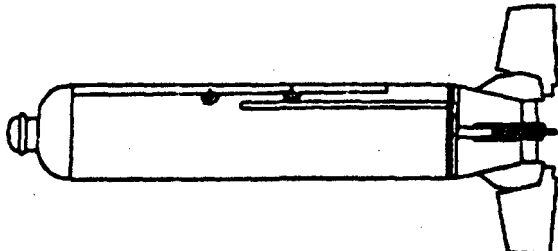
NOMENCLATURE SUU-65/B		NAME TMD	
WEAPON CHARACTERISTICS			
WEIGHT- 950 Lbs max (215 Lbs empty)			
LENGTH- 92 in			
DIAMETER- 18 in			
GUIDANCE- None			
CONTROLS- Spin			
AUTOPILOT- None			
PROPULSION- None			
WARHEAD- see submunitions			
FUZE- Integral fuze			
HOB 300 FT. TO 3000 FT. SETTABLE			
FZU- 39/b Prox sensor			
PICTORIAL			
			
EMPLOYMENT OPTIONS			
AIRCRAFT		SUBMUNITIONS	
F-4	(6)	BLU-99/B	(48)
F-16	(4)	BLU-101/B	(9)
F-111	(8)	BLU-102/B	(12)
A-10	(4)	BLU-97/B	(202)
A-7	(4)	{BLU-91/B}	(72) AT
B-52D	(180)	{BLU-92/B}	(22) AP
		SKEET	(64)
ENGAGEMENT SYSTEMS			
None			
LAUNCHER			
MER/TER & MSER			
PROGRAM MANAGEMENT			
CONTRACTOR- HONEYWELL			
UNIT COST- \$3474			
STATUS- PRODUCTION			
NEXT EVENT-			
REFERENCE- MR. VALADE AV 872-3000			

TARGETS ARMOR

SHORT RANGE

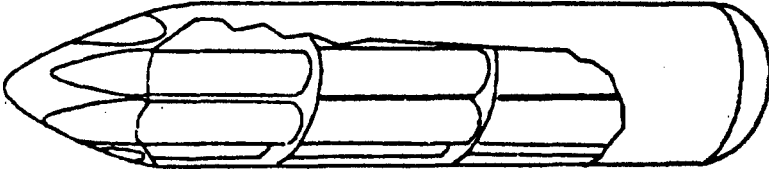
NOMENCLATURE		NAME WASP POD
WEAPON CHARACTERISTICS		
WEIGHT- 1813 LBS LENGTH- 210 IN DIAMETER-22 X 24 IN GUIDANCE-N/A CONTROLS-N/A AUTOPILOT-N/A PROPULSION-N/A WARHEAD-WASP Submunitions FUZE-N/A		
PICTORIAL		
		
EMPLOYMENT OPTIONS		
SUBMUNITIONS WASP (8)		
AIRCRAFT F-16 (2) F-111 (4) A-10 (2) PODS F-4 (2) A-7 (2) NATO		
ENGAGEMENT SYSTEMS PAVE MOVER INERTIAL SYSTEM		
PROGRAM MANAGEMENT CONTRACTOR-HUGHES UNIT COST- \$270,200 POD LOADED WITH 8 MISSILES STATUS-COMPLETED VALIDATION NEXT EVENT- NEW MMW TECH 87 START REFERENCE- LT COL BUCHNER AV 872-5808		

SUBMUNITIONS

TARGETS LIGHT MATERIAL

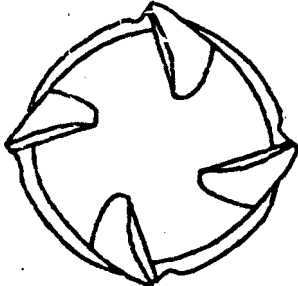
NOMENCLATURE: BLU-63/B	NAME
WEAPON CHARACTERISTICS WEIGHT- 931 LBS. LENGTH- SPHERICAL DIAMETER- 2 9 IN GUIDANCE- None CONTROLS- None AUTOPILOT- None PROPULSION- None WARHEAD- 25 LBS HE FUZE- M219 CONTACT	
PICTORIAL 	
EMPLOYMENT OPTIONS DISPENSER SUU-30H/B (650) PROGRAM MANAGEMENT CONTRACTOR- USA UNIT COST- < \$5 00 STATUS- INVENTORY NEXT EVENT- REFERENCE- JMEM 6-60	

TARGETS LIGHT MATERIAL, PERSONNEL

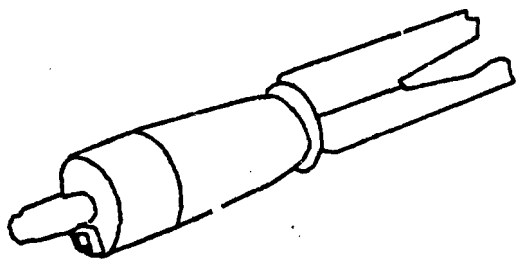
NOMENCLATURE BLU-77/B		NAME APAM
WEAPON CHARACTERISTICS		
WEIGHT- 0.82 LBS LENGTH- 8.8 IN. DIAMETER- 1.58 IN. GUIDANCE- None CONTROLS- None AUTOPILOT- None PROPULSION- None WARHEAD- 0.12 LBS HE SHAPED CHARGE FUZE- HARD TARGET CONTACT AND SOFT TARGET TIMED DELAY		
ZIRCONIUM CUP FOR INCINDERY		
PICTORIAL		
		
EMPLOYMENT OPTIONS		
DISPENSER MK 7 MOD 3 (717) (CBU-50/B)		
PROGRAM MANAGEMENT CONTRACTOR- UNIT COST- STATUS- INVENTORY NEXT EVENT- REFERENCE- JMEM 6-64		

TARGETS PERSONNEL/ARMOR/AIRFIELDS

MEDIUM RANGE

NOMENCLATURE BLU-80/B

NAME BIGEYE

WEAPON CHARACTERISTICS

WEIGHT-2650 LBS
LENGTH-154 IN
DIAMETER- 20 IN
GUIDANCE- IIR/TV/DATA LINK
CONTROLS- TAIL
AUTOPILOT- PITCH AND YAW RATE, ROLL POSITION
PROPULSION- None
WARHEAD- SUU-54/BLU-63 (CBU-75)
FUZE- FMU-123/B

PICTORIAL

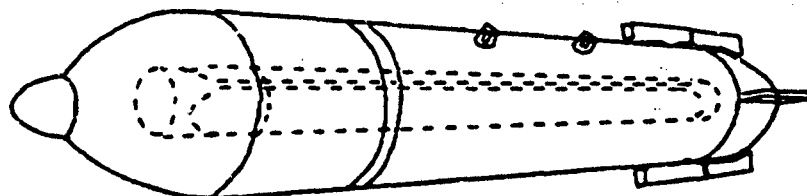

EMPLOYMENT OPTIONS

DISPENSER
SUU-54

SUBMUNITIONS

{BLU-63/B	(1470)}	} CBU-75
{BLU-86/B	(370)}	
BLU-97/B	(415)	
BLU-91/B	(170)	
BLU-92/B	(170)	
BKEP	(35)	

PROGRAM MANAGEMENT

CONTRACTOR-HUGHES/ROCKWELL
UNIT COST-TBD
STATUS-PRODUCTION DECISION?
NEXT EVENT-
REFERENCE-MR. PRESCOTT 872-4261

TARGETS VEHICLES, AIRCRAFT

NOMENCLATURE	BLU-81/B	NAME	STAM
<p>WEAPON CHARACTERISTICS</p> <p>WEIGHT- 80 Lbs LENGTH- 19 In DIAMETER- 4.75 In GUIDANCE- RF & IR CONTROLS- Single fin AUTOPILOT- Spin stabilized PROPULSION- Boost (ejected) WARHEAD- 25 M-42 SHAPED CHARGE BOMBLETS IN EACH MINE FUZE- Seismic</p>			
<p>PICTORIAL</p> 			
<p>EMPLOYMENT OPTIONS</p> <p>DISPENSERS TMD (9) SUU-54 (18)</p> <p>LIMITATIONS Heavy foliage may reduce effectiveness</p> <p>AIRCRAFT A-10 (2) F-16 (2) F-4 (2)</p> <p>PROGRAM MANAGEMENT CONTRACTOR- GENERAL DYNAMICS UNIT COST- STATUS- DISCONTINUED NEXT EVENT- REFERENCE- MR BIELE AV 872-8501</p>			

TARGETS ARMOR

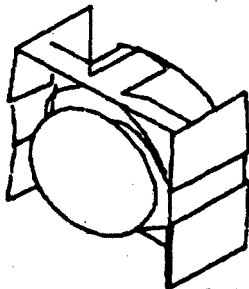
NOMENCLATURE	BLU-91/B	NAME	GATOR
WEAPON CHARACTERISTICS			
WEIGHT-4 31 Lbs LENGTH- DIAMETER-5 7 x 5 0 x 2 0 In GUIDANCE-None CONTROLS-None AUTOPILOT-None PROPULSION-None WARHEAD- Mass focus FUZE- Magnetic			
PICTORIAL			
			
EMPLOYMENT OPTIONS			
DISPENSER SUU-64/B non-spin TMD (72)			
WEAPON SYSTEM CBU-89/B			
PROGRAM MANAGEMENT CONTRACTOR-HONEYWELL UNIT COST-\$197 STATUS-PRODUCTION NEXT EVENT- REFERENCE- MR VALADE AV 872-3000			

TARGETS PERSONNEL

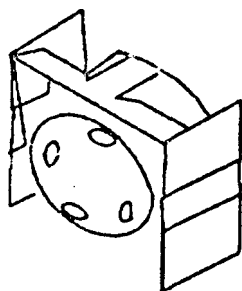
NOMENCLATURE	BLU-92/B	NAME	GATOR
WEAPON CHARACTERISTICS			
HEIGHT-5 75 Lbs LENGTH-5 7 x 5 0 x 2 6 In. DIAMETER-5 7 x 5 0 x 2 6 In. GUIDANCE-None CONTROLS-None AUTOPILOT-None PROPULSION-None WARHEAD-FRAGMENTATION FUZE-TRIP WIRE			
PICTORIAL			
			
EMPLOYMENT OPTIONS			
DISPENSER SUU-64/B non-spin TMD (22)			
WEAPON SYSTEM CBU-89/B			
PROGRAM MANAGEMENT CONTRACTOR-AEROJET GENERAL UNIT COST- \$339 STATUS- PRODUCTION NEXT EVENT- REFERENCE- MR. VALADE AV 872-3000			

TARGETS PERSONNEL, LIGHT MATERIAL

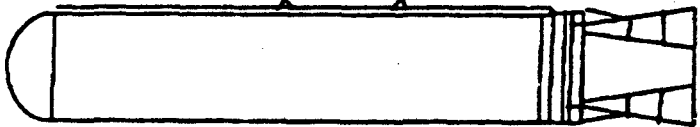
NOMENCLATURE BLU-95/B, BLU-96/B		NAME FAE II
WEAPON CHARACTERISTICS		
WEIGHT- 515 LBS AND 2000 LBS LENGTH- 92 IN AND 158 IN DIAMETER- 15 IN AND 23 5 IN GUIDANCE- None CONTROLS- None AUTOPILOT- None PROPULSION- None WARHEAD- 315 LBS AND 1420 LBS PROPYLENE OXIDE FUZE- DSU-23/B TARGET DETECTION DEVICE (30-40 FT PROX) FSU-9/B S&A		
PICTORIAL		
		
EMPLOYMENT OPTIONS		
AIRCRAFT F-4 (4-6) F-16 (4-6) F-111 (6) A-10 (4-6)		
ENGAGEMENT SYSTEMS BOMBING COMPUTER		
LAUNCHER MER/TER		
PROGRAM MANAGEMENT CONTRACTOR- NAVY UNIT COST- STATUS-DISCONTINUED NEXT EVENT- REFERENCE- JMEM 1-44		

TARGETS PERSONNEL, LIGHT ARMOR

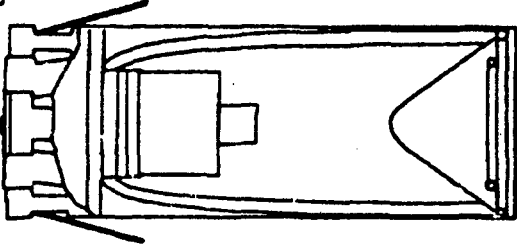
NOMENCLATURE	BLU-97/B	NAME	CEB
WEAPON CHARACTERISTICS			
WEIGHT- 3 4lbs			
LENGTH- 6 6 ins after release 10 2 ins			
DIAMETER- 2 51 In.			
GUIDANCE- N/A			
CONTROLS- Balancing stabilizer			
AUTOPILOT-			
PROPULSION-N/A			
WARHEAD- Shaped charge, fragment with Zn incendiary			
FUZE- CONTACT			
PICTORIAL			
			
EMPLOYMENT OPTIONS			
DISPENSER			
202 CEB'S CAN BE CARRIED IN THE SUU 65/9			
WEAPON SYSTEM			
CBU-87/B			
PROGRAM MANAGEMENT			
CONTRACTOR- AEROJET GENERAL			
UNIT COST- \$30			
STATUS- PRODUCTION			
NEXT EVENT-			
REFERENCE- MAJ. COOPER AV 872-3000			

TARGETS HEAVY ARMOR

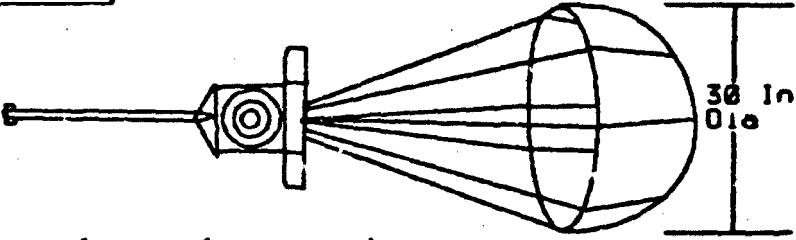
NOMENCLATURE BLU-99/B		NAME ACM
WEAPON CHARACTERISTICS		
WEIGHT-14 Lbs LENGTH-7.78 In high DIAMETER-6.8 In wide wedge shaped GUIDANCE-None CONTROLS-None AUTOPILOT-None PROPULSION-None WARHEAD-Self forging frag FUZE-contact		
PICTORIAL		
		
Flat panel cruciform parachute		
EMPLOYMENT OPTIONS		
DISPENSER SUU-65/B (18)		
WEAPON SYSTEM CBU-90/B		
PROGRAM MANAGEMENT CONTRACTOR-HONEYWELL UNIT COST- \$300 STATUS-TERMINATED NEXT EVENT- REFERENCE- AD/YA AV 872-8418		

TARGETS: ARMORED VEHICLES

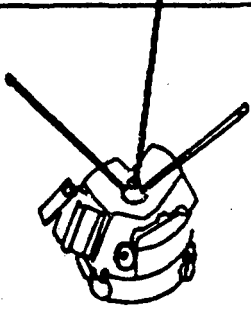
NOMENCLATURE	BLU-101/B	NAME	ERAM
WEAPON CHARACTERISTICS			
WEIGHT- 80 lbs. LENGTH- 8 0 In DIAMETER-14 In GUIDANCE-N/A CONTROLS-N/A AUTOPILOT-N/A PROPULSION-N/A WARHEAD-4.7 In SFF FUZE-IR airborne sensor			
PICTORIAL			
			
EMPLOYMENT OPTIONS			
NUMBER S/M PER DISPENSER		9	
NUMBER AT W/H PER S/M		2	
NUMBER OF CFM PER S/M:		3	
AIRCRAFT		WEAPON SYSTEM	
F-16	(4) PODS	CBU-92/B	
F-111	(8) PODS		
F-4	(4) PODS		
A-10	(4) PODS		
A-7	(4) PODS		
DISPENSER			
SUU-65/B			
PROGRAM MANAGEMENT			
CONTRACTOR-		AVCO	
UNIT COST-		\$1737 FY82*	
STATUS-		TERMINATED	
NEXT EVENT-			
REFERENCE-		MR. HILL AV872-8384	

TARGETS - AIRFIELDS

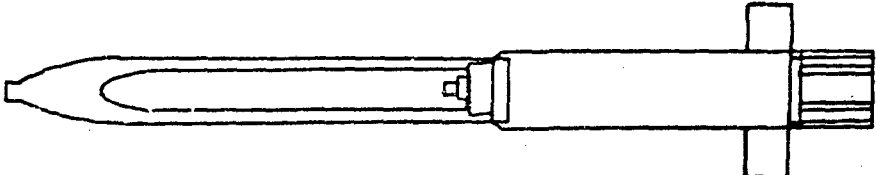
NOMENCLATURE: BLU-108		NAME BKEP
WEAPON CHARACTERISTICS		
WEIGHT- 45 LBS. LENGTH- 43 5 IN DIAMETER- 3 35/4 Ø IN GUIDANCE- None CONTROLS- PARACHUTE RETARDED AUTOPILOT- None PROPULSION- BOOST ONLY WARHEAD- 6 5 LBS H.E FUZE- ELECTRONIC/PYROTECHNIC		
PICTORIAL		
		
EMPLOYMENT OPTIONS		
DISPENSER MRASM JTACMS TMD (8) AXE SAW SU-54 (15)		
PROGRAM MANAGEMENT CONTRACTOR- USA UNIT COST- \$2500 STATUS- NEXT EVENT- REFERENCE- MR. CALUDA AV872-5375		

TARGETS ARMOR

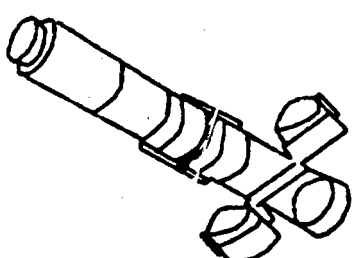
NOMENCLATURE BLU-108		NAME . SFW SUBMUNITION
WEAPON CHARACTERISTICS		
WEIGHT- SDVA 55 LBS SKEET 9 LBS LENGTH- SDVA 31 IN SKEET 3 75 IN THICK DIAMETER- SDVA 5 25 IN SKEET 5 0 IN GUIDANCE- SDVA LASER ALT SKEET IR (PbSe) CONTROLS- SPIN STABILIZED AUTOPILOT- None PROPULSION- JET REACTORS WARHEAD- 4 SKEET SFF PER SDVA FUZE- SEEKER FUZE		
PICTORIAL		
		
EMPLOYMENT OPTIONS		
AIRCRAFT		SUBMUNITION
A-10 (4)		SDVA (10) PER TMD
F-4 (4)		
F-16 (4)		
F-111 (8)		
A-7 (6)		DISPENSER
F-15 (6)		TMD
ENGAGEMENT SYSTEMS		
BOMBING COMPUTER		
PROGRAM MANAGEMENT		
CONTRACTOR- AVCO		
UNIT COST- \$5K PER SDVA		
STATUS- PRE FSD		
NEXT EVENT- FSD MAY 84		
REFERENCE- MR STONE AV 872-0448		

TARGETS: ARMOR

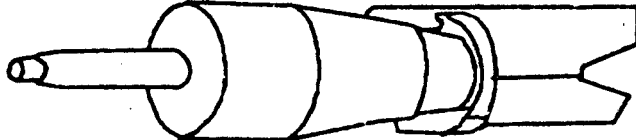
NOMENCLATURE MK 118		NAME ROCKEYE
WEAPON CHARACTERISTICS		
WEIGHT- 1 32 LBS LENGTH- 2 1 IN DIAMETER- 1 91 IN GUIDANCE- None CONTROLS- None AUTOPILOT- None PROPULSION- None WARHEAD- 0 40 LBS HE COPPER SHAPED CHARGE FUZE- CONTACT PIEZOELECTRIC		
PICTORIAL		
		
EMPLOYMENT OPTIONS		
DISPENSER MK 7 MOD 2		
WEAPON SYSTEM MK 20 ROCKEYE		
PROGRAM MANAGEMENT CONTRACTOR- USA UNIT COST- < \$10.00 STATUS- INVENTORY NEXT EVENT- REFERENCE- JMEM 6-76		

TARGETS LIGHT ARMOR

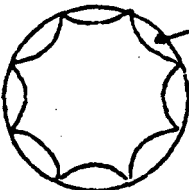
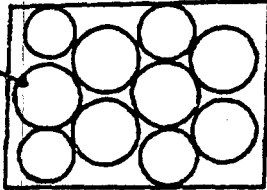
NOMENCLATURE		NAME AMIS
WEAPON CHARACTERISTICS		
WEIGHT-14- 18 Lbs LENGTH-8 9-10.4 In DIAMETER-4 8-5.4 In GUIDANCE-N/A CONTROLS-N/A AUTOPILOT-N/A PROPULSION-N/A WARHEAD-Self-forging frag Zn or Ti incendiary FUZE- Contact, extended probe		
PICTORIAL		
	SELF FORGING FRAGS	
END VIEW		SIDE VIEW
EMPLOYMENT OPTIONS		
DISPENSERS TMD HAMMER MRASM BOSS		
AIRCRAFT A-10 A-7 F-16		
NUMBER DEPENDS ON DISPENSER		
PROGRAM MANAGEMENT CONTRACTOR- HONEYWELL/CHAMBERLIN UNIT COST- \$300 FY82 STATUS- TERMINATED NEXT EVENT- REFERENCE- MR. BRIERE AV8722085		

TARGETS BUNKERS

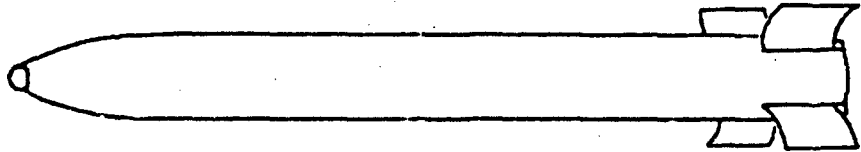
NOMENCLATURE	NAME BTM
WEAPON CHARACTERISTICS WEIGHT-359.13lbs LENGTH-77 in DIAMETER-8 3 in GUIDANCE- UNGUIDED SUBMUNITION CONTROLS- AUTOPILOT-None PROPULSION- WARHEAD-42 8 LBS AFX-708 FUZE-G-level sensor	
PICTORIAL BUNKERED TARGET MUNITION 	
EMPLOYMENT OPTIONS DISPENSERS MRASM ALCM Advanced Cruise Missile HAMMER ENGAGEMENT SYSTEMS Inertial sensors AIRCRAFT B-52 F-111 (4) F-16 (2) DEPENDS ON DISPENSER PROGRAM MANAGEMENT CONTRACTOR- LOCKHEED UNIT COST- STATUS- NEXT EVENT- TERMINATED REFERENCE- AL WEIMORTS AV8722005	

TARGETS: ARMORED VEHICLES

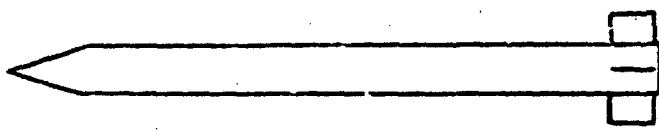
NOMENCLATURE	NAME HVM
WEAPON CHARACTERISTICS WEIGHT-40-45 LBS. LENGTH-85 IN DIAMETER-4 0 IN. GUIDANCE-Laser command CONTROLS-THRUSTERS AUTOPILOT-ROLL REFERENCE PROPULSION-BOUST-SUSTAIN WARHEAD-6-8 LBS. K.E. ROD FUZE-None	
PICTORIAL 	
EMPLOYMENT OPTIONS AIRCRAFT F-16 (2) (PODS) A-10 (2) (PODS) ENGAGEMENT SYSTEM Aircraft target acq / track sys. Laser data link Advanced Lantirn pod LAUNCHER Multi-missile pod (20 missiles) PROGRAM MANAGEMENT CONTRACTOR-VOUGHT UNIT COST- 6410 FY82\$ EST STATUS-GROUND LAUNCH DEMO 1983 NEXT EVENT- REFERENCE-MR. SHIREY AV8728877	

TARGETS. RUNWAYS

NOMENCLATURE		NAME RIM
WEAPON CHARACTERISTICS		
WEIGHT- 25lbs LENGTH- 20ins DIAMETER- 4.75ins GUIDANCE- N/A CONTROLS- N/A AUTOPILOT- N/A PROPULSION- N/A WARHEAD- 4 5lb SHAPED CHARGE DUAL STAGE FUZE- RANDOM DELAY		
PICTORIAL		
		
EMPLOYMENT OPTIONS		
DISPENSER LAD--48 SUBMUNITIONS HAMMER (TBU) MRASM		
PROGRAM MANAGEMENT CONTRACTOR- AEROJET GENERAL UNIT COST- \$525 FY82 STATUS- TERMINATED NEXT EVENT- REFERENCE-		

TARGETS AIRFIELDS

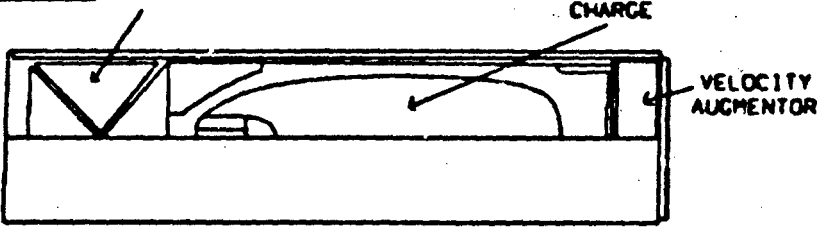
NOMENCLATURE		NAME VAM
WEAPON CHARACTERISTICS		
WEIGHT-22-26 LBS LENGTH-14-15 IN. DIAMETER-4 5-5 Ø IN GUIDANCE-None CONTROLS-None AUTOPILOT-None PROPULSION-VELOCITY AUGMENTOR WARHEAD-FORWARD CHARGE ~2 5 LBS FOLLOW THROUGH ~4 5 LBS FUZE-IMPACT DELAY		
PICTORIAL		
		
EMPLOYMENT OPTIONS		
DISPENSER MRASH (38) HAMMER (TBD)		
PROGRAM MANAGEMENT CONTRACTOR- LAWRENCE LIVERMORE UNIT COST- STATUS- NEXT EVENT- REFERENCE-M CALUDA AV8725375		

TARGETS ARMOR

NOMENCLATURE	NAME WASP-MISSILE
--------------	-------------------

WEAPON CHARACTERISTICS

WEIGHT- 120 Lbs.
 LENGTH- 60 in
 DIAMETER- 8 in
 GUIDANCE- MMW
 CONTROLS-
 AUTOPILOT-BIAS PURSUIT
 PROPULSION- BOOST SUSTAIN
 WARHEAD- 20 Lbs. SHAPED CHARGE
 FUZE- CONTACT

PICTORIAL

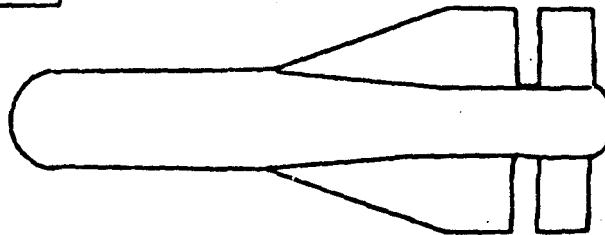

EMPLOYMENT OPTIONS

AIRCRAFT (PRIMARY)

F-16 (2) A-7 (2)
 F-111 (4) F-4 (2) PODS
 A-10 (2)
 NATO

LAUNCH MODES

BLIND LAUNCH
 CLOSE AIR SUPPORT

ENGAGEMENT SYSTEMS

PAVE MOVER
 INERTIAL SYSTEM

LAUNCHER

WASP POD (PLYON MOUNTED)
 22 x 24 in
 210 in long 8 MSLS LOAD

PROGRAM MANAGEMENT

CONTRACTOR-HUGHES
 UNIT COST- \$32,500 FY82 OVE MSL
 STATUS- COMPLETED VALIDATION
 NEXT EVENT-TERMINATED
 REFERENCE-