

C10

**GERMAN
HAND & RIFLE
GRENADES**

INTRODUCTION

The grenades used by the German Army may be categorized as follows:

HAND GRENADES

1. High Explosive Grenades.
 - a. Anti-personnel grenades--these are of the "offensive" type; that is, they have a thin metal casing with a high proportion of explosive filler. Being of this type, they depend upon the blast effect, instead of the fragmentation of the case as in the "defensive" types used by other countries.
 - b. Anti-tank grenades--these are larger than the anti-personnel grenades and make use of the shaped charge to increase the penetrating power of the grenade.
2. Chemical Grenades.
 - a. Smoke grenades--these are either adaptations of the anti-personnel grenades or frangible grenades in which the filler is contained in a glass bottle.
 - b. Gas Grenades.
 - c. Smoke signals--these may be either thrown or placed on the ground.

RIFLE GRENADES

1. Rifle propelled--these are two attachments which may be fitted to the standard infantry rifle for firing these grenades: a cup discharger and a spigot discharger.
 - a. High Explosives.
 - (1) Anti-personnel grenades.
 - (2) Anti-tank grenades.
 - b. Propaganda grenades.
2. Pistol propelled--these grenades are fired from either the standard signal pistol or from the signal pistol modified by the addition of rifling and a sight.
 - a. High Explosives.
 - b. Chemical Grenades.
 - (1) Smoke grenades.
 - (2) Signal grenades.

CORRECTIONS & ADDITIONS TO
GERMAN HAND & RIFLE GRENADES

Page 1 - Table of Contents, German Hand & Rifle Grenades.

Under 37 mm Anti-Tank Grenade - Add: Hollow Anti-Tank Grenade . . Pg.35(b)

Page 3 - Stick Hand Grenade, Models 24 & 39.

Remarks - Add: (b) A training model has been recovered. The metal head is painted red with the normal grenade stick being used. The model is fused with the normal B.Z.24 igniter and a small black powder charge gives the realistic sound effects. Identifying markings are "Ub-stielhand granate 24".

(c) A red knob means one second delay; a grey knob, no delay; and a blue knob, 4.5 seconds delay. Grenades with red and grey metal caps or knobs are likely to be used as booby traps.

Page 27 - Anti-Tank Rifle Grenade.

Filler - T.N.T. Add:or cast pentolite.

Number of sheets in this group of additions & corrections 4

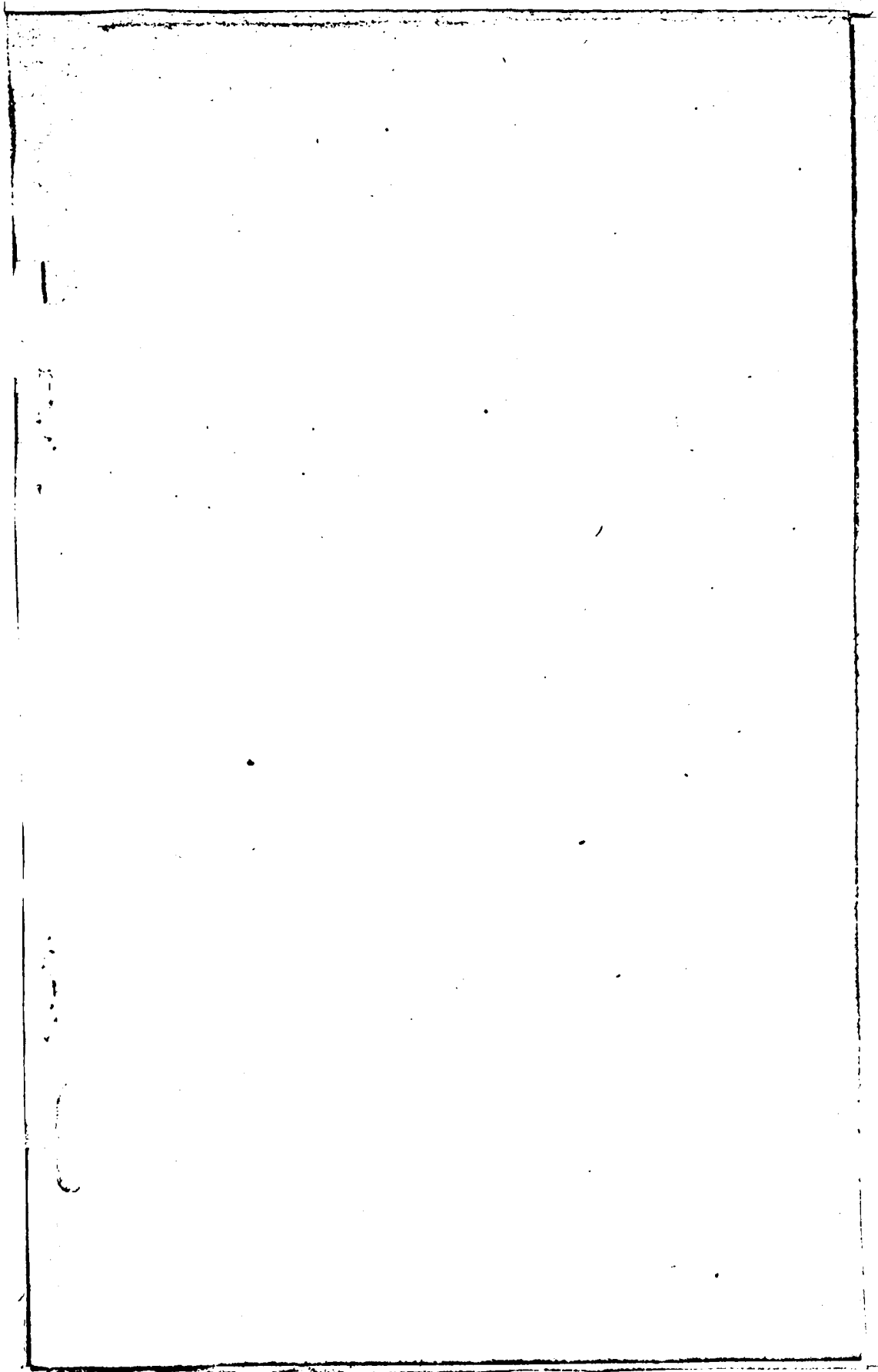

ADDITIONS & CORRECTIONS
GERMAN HAND & RIFLE GRENADES

No. 2

There are 7 pages in this set of additions and corrections.

- - - - -

Table of Contents - ADD:

Danish Hand Grenade	Pg. 5(b)
Hollow Charge Rifle Grenade	29(b)
Illuminating Rifle Grenade	31(b)

Page 11 - Weight: CHANGE to 1.5 Kg.
Filling: ADD - 50/50 RDX/TNT
ADD: Weight of Filling 18.5 oz.

Page 45 - DELETE item No. 3 on Illuminating Star on Parachute.

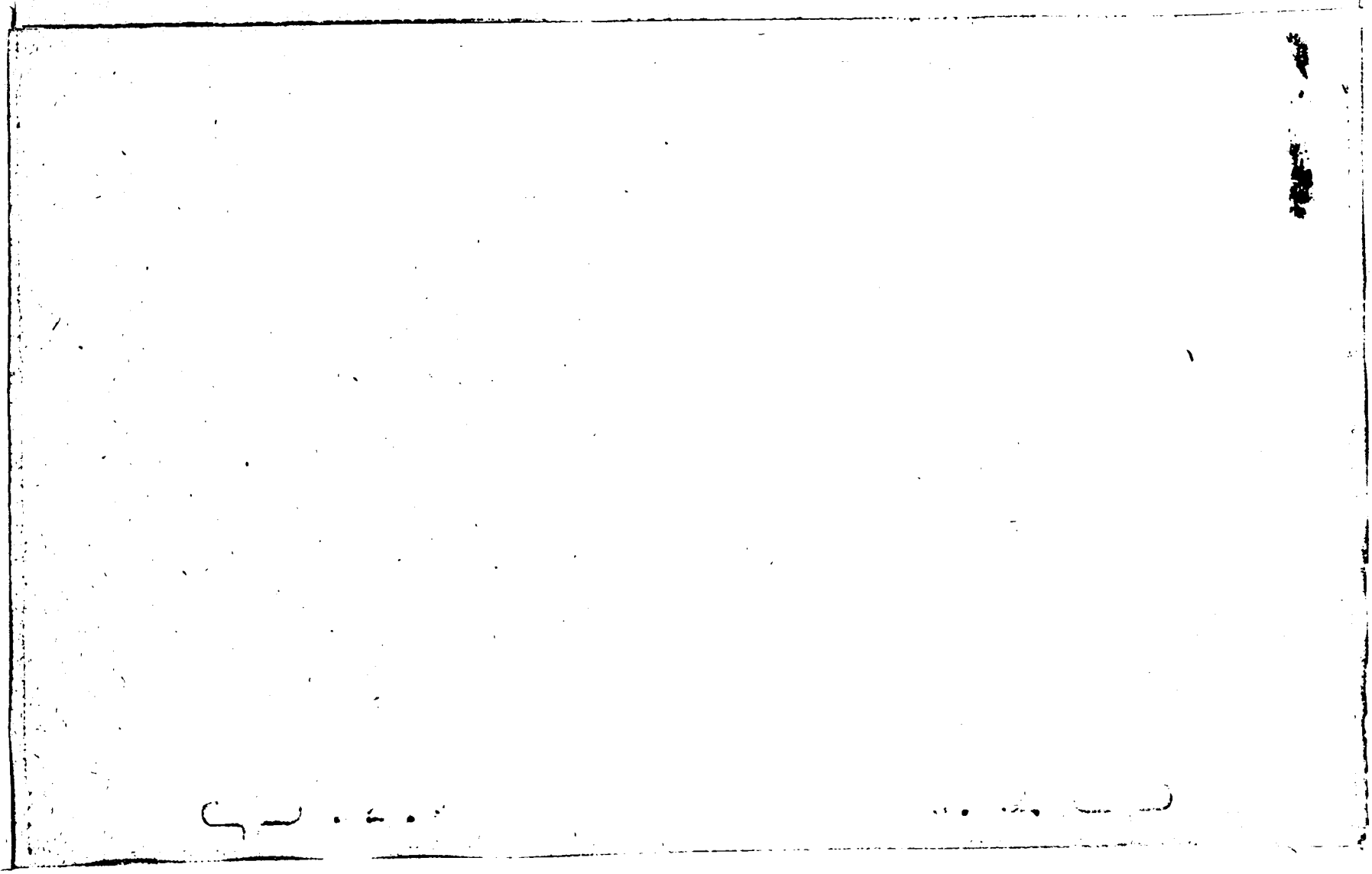

سید . . .

سید . . .

TABLE OF CONTENTS

Stick Hand Grenade.....	3
Egg Hand Grenade.....	5
Shaving Stick Hand Grenade.....	7
Anti-Tank Magnetic Hand Grenade.....	9
Anti-Tank Hand Grenade.....	11
Smoke Hand Grenade (Stick).....	13
Smoke Hand Grenade 41.....	15
Frangible Smoke Hand Grenade 1H.....	17
Frangible Smoke Hand Grenade 2H.....	19
Hand Smoke Signal.....	21
Lachrymatory Hand Grenade.....	23
Anti-Personnel Hand or Rifle Grenade.....	25
Anti-Tank Rifle Grenade.....	27
Large Anti-Tank Rifle Grenade.....	29
Rifle Propaganda Grenade.....	31
Spigot Discharger Rifle Grenade.....	33
37mm Anti-Tank Grenade.....	35
High Explosive Pistol Grenade (326).....	37
High Explosive Pistol Grenade (361).....	39
Pistol Signal Cartridge	41
High Explosive Pistol Grenade.....	43
Rifle Grenade Propelling Cartridges.....	44
Miscellaneous Pistol Grenades.....	45
Rifle Discharger (Cup Type).....	46
Rifle Discharger (Spigot Type).....	47
Grenade and Signal Pistol.....	48
Flare Pistol.....	49

GERMAN STICK HAND GRENADE MODEL 24

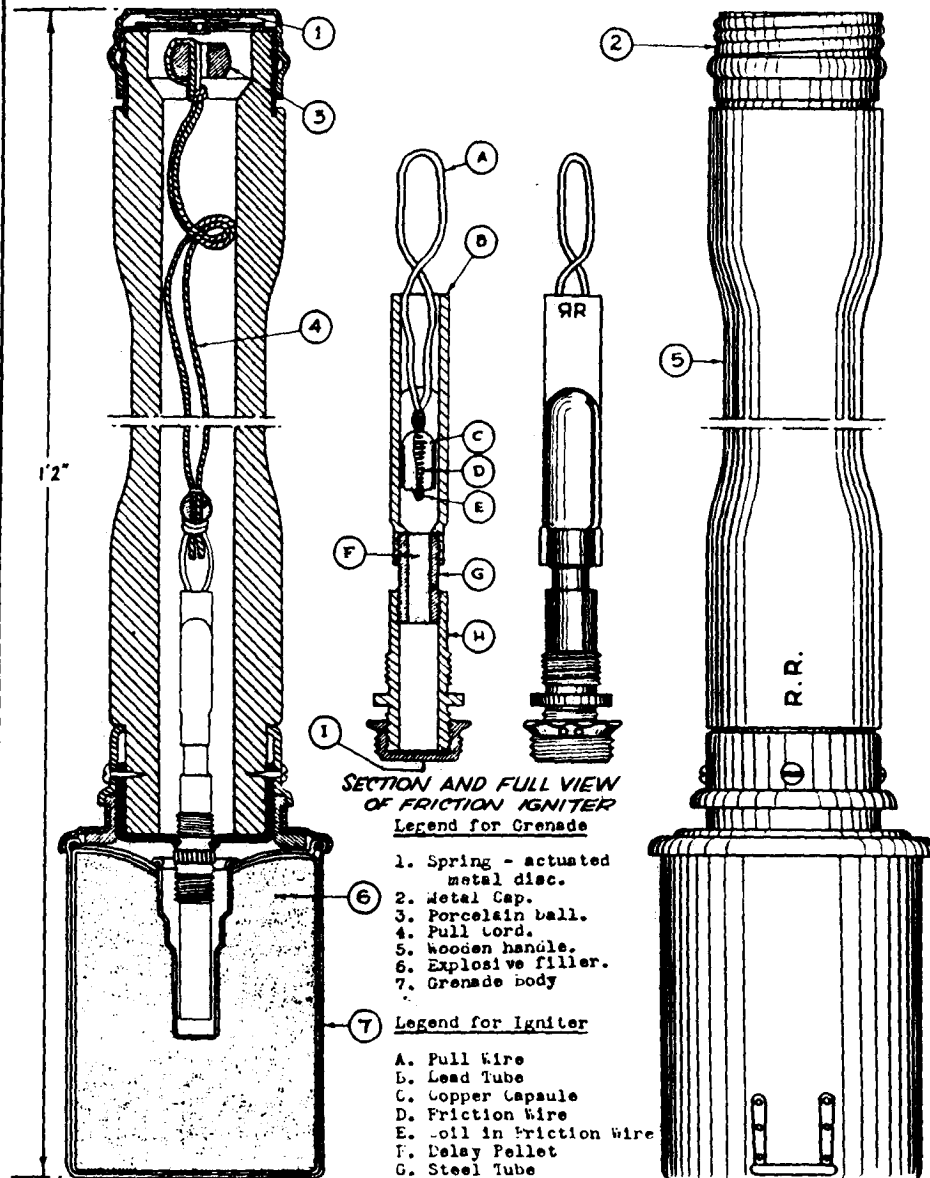

**SECTION AND FULL VIEW
OF FRICTION IGNITER**
Legend for Grenade

1. Spring - actuated metal disc.
2. Metal Cap.
3. Porcelain ball.
4. Pull cord.
5. Wooden handle.
6. Explosive filler.
7. Grenade body

Legend for Igniter

- A. Pull wire
- B. Lead Tube
- C. Copper Capsule
- D. Friction Wire
- E. Coil in Friction Wire
- F. Delay Pellet
- G. Steel Tube
- H. Brass Fitting
- I. End Cap

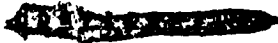

Data - MODEL 24

Overall length	1' 2"
Diameter of body	2-3/4"
Color of body	Olive drab.
Weight	1/2 lb.
Weight of explosive filler	6 ozs.
Explosive Filler	T.N.T.
Igniter	B.Z. 24
Delay	4 - 5 sec.

Data - MODEL 39

Overall length	1' 4"
Color	Olive drab.
Weight	1 lb. 6 oz.
Weight of explosive filler	7 ozs.
Igniter	B.Z. 24
Effective blast radius	16 yards.
Delay	4 - 5 sec.

Description

These grenades are similar in all characteristics except size.

These grenades consist of a thin iron or steel casing, or head, containing the explosive filler, which is screwed onto a hollow wooden handle, through the center of which runs a double length of cord. This cord is attached at one end to a lead ball which is part of the igniter, and at the other end to a porcelain ball. The cavity in which the porcelain ball rests is closed by a metal cap that screws on. Inside the cap is a spring - actuated metal disc that prevents movement of the porcelain ball.

These grenades use igniter B.Z.24 consisting of a lead tube or sheath connected to a threaded brass fitting by a short steel tube. The steel tube is threaded on both ends and contains the powder delay pellet. The lead tube contains the copper capsule which holds the friction composition. The friction wire is cast in the friction composition contained in the capsule being coiled at the bottom to provide resistance to pulling and joined to the "pull" loop at its opposite end. When the loop is pulled it frees itself from the lead tube drawing the wire through the friction composition and the resulting flame ignites the delay pellet.

Operation

The metal cap is unscrewed from the handle and the porcelain ball is pulled. This will pull a wire through the delay pellet. The grenade is then thrown and after a 4 - 5 sec. delay the delay pellet will initiate the detonator.

GERMAN

STICK HAND GRENADE

MODELS 24 & 39

STIELHANDGRANATES 24 & 39

— GERMAN —
EGG - TYPE
HAND GRENADE
MODEL 39

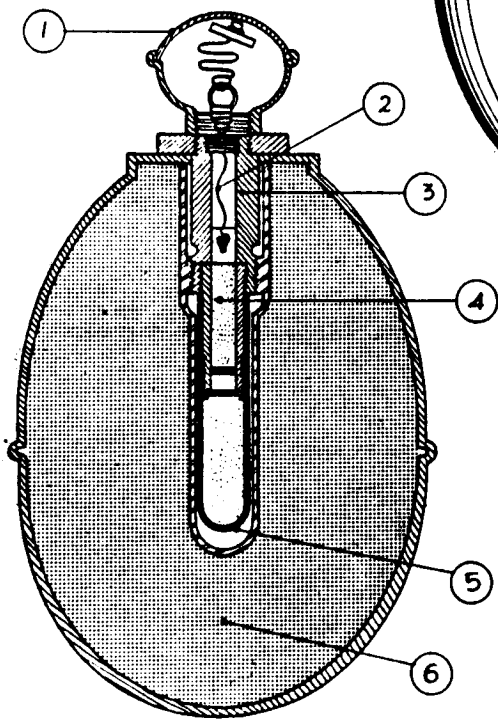
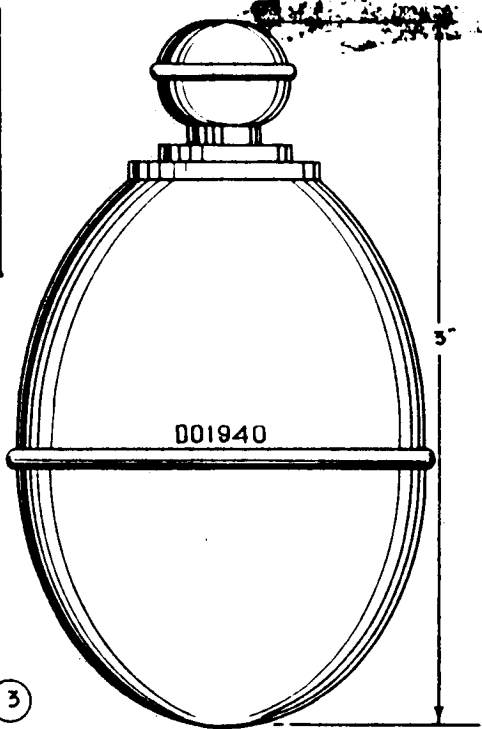

- LEGEND:
- 1. Igniter Knob.
 - 2. Friction Wire.
 - 3. Grenade Igniter.
 - 4. Delay Pellet.
 - 5. Detonator.
 - 6. Explosive Filler.



Data

Overall length 3 inches.
 Maximum diameter 2 inches.
 Color Black body
 with blue
 igniter head.
 Weight 12 ounces.
 Igniter B.Z.E.
 Delay 4-5 seconds.

GERMAN

EGG-TYPE

HAND GRENADE

EIERHANDGRANATE 39

Description

This is a small thin-cased offensive type grenade with a high proportion of a low-grade explosive. It is ignited by a friction type igniter and a 4 -5 second delay pellet.

This grenade uses the B.Z.E. friction type igniter. The short body of this igniter is usually made of brass and contains a friction composition in which a friction pull wire is cast. The lower end of the friction wire is coiled to provide resistance which serves to ignite the friction composition when the wire is drawn through it. The upper end of the friction wire has a loop to which is fastened one end of a cord. The free end of the cord is attached to a disc which is within the head. The head screws on to the top of the body and a steel tube containing the delay pellet screws into the bottom of the body.

There has been found a practice hand grenade of this type containing a spotting charge with the B.Z.E. igniter. The German designation of this is the Eierhandgranate 39 (Ub).

Operation

The igniter head is unscrewed and pulled thus drawing the wire through the friction composition and igniting the delay pellet. The grenade is then thrown and after a delay of 4 - 5 seconds the delay pellet will initiate the detonator thus setting off the explosive filler.

Remarks

A modified egg grenade has been found with a ring attachment on the base.

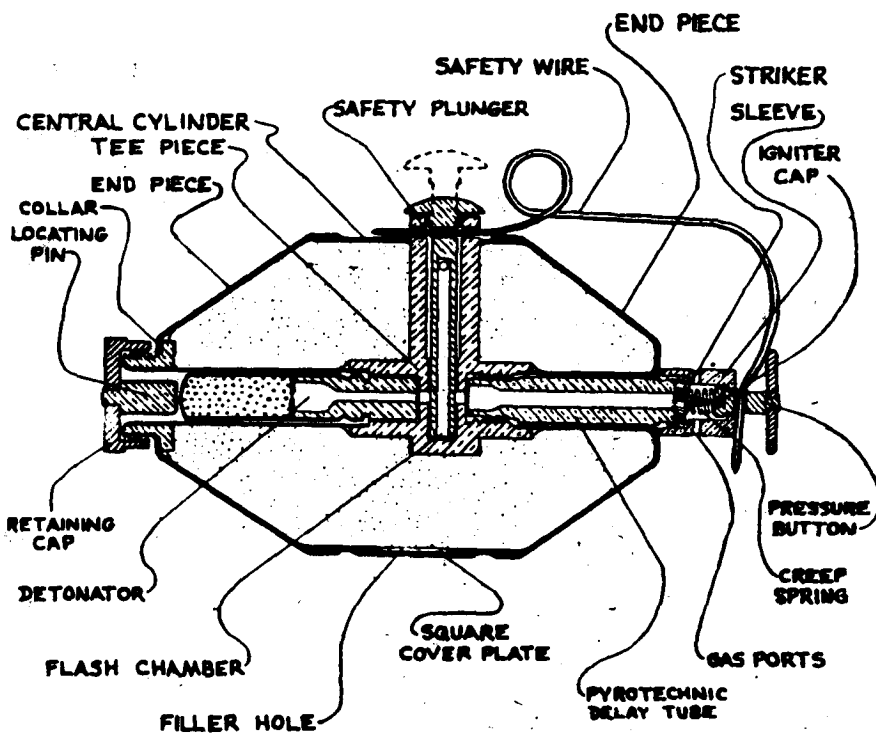
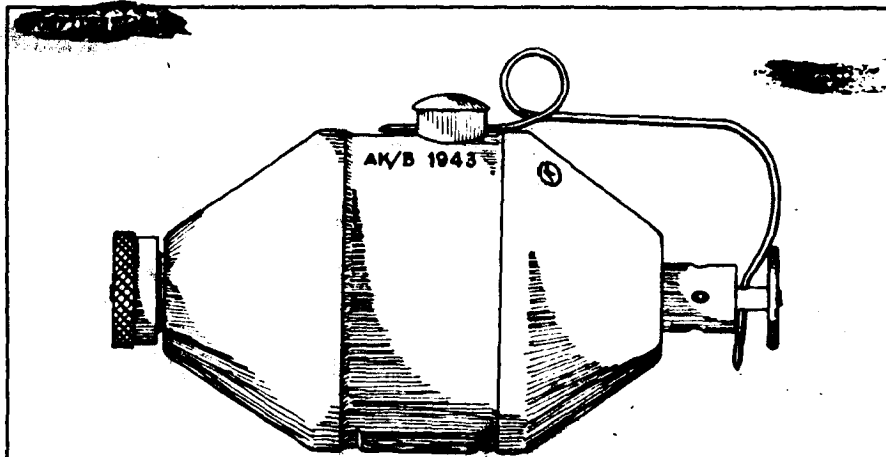

DANISH HAND GRENADE

DANISH

HAND GRENADE

Date

Overall Length 5-1/16 in.
Maximum diameter 2-5/16 in.
Color & Markings Field Grey.
AR/B 1943 X
Total Weight 13 oss.
Weight of charge 5 os.
Type of Filling Powdered TNT

Description

Casing - The casing is of galvanized steel, approximately 1/32" thick and is made up of a central cylinder with two cup-shaped ends sweated on to it. A filler hole 7/16" in diameter in the central cylinder has a small square plate sweated over it.

Igniter Assembly - A brass tubular tee piece is sweated into the casing; the cross arms run longitudinally through the grenade; the stem protrudes from the side of the grenade. Into one end of the longitudinal tube a detonator is inserted. The tube at this end is sweated into a brass collar which is sweated to the casing. The collar is screwed to take a knurled brass retaining cap which has an internal pin protruding from its center to locate the detonator. The other end of the longitudinal tube is sweated to the casing. Inserted into this end and screwed into the junction of the tee is a brass pyrotechnic delay tube which is sweated with some form of luting. The outside end of this tube is screwed externally and has a flat brass striker set into it. A brass sleeve, having four gas ports across over the outside end of the pyrotechnic delay tube. The stem of a pressure button, holding an igniter cap, slides within the brass sleeve. A creep spring holds the cap from the striker. In the center of the tee piece is a flash chamber which may be closed by the hollow safety plunger which slides into the stem of the tubular tee piece. A spring steel safety wire is threaded through the stem of the pressure button at one end and through the protruding end of the stem of the tubular tee piece and safety plunger at the other end. A second hole piercing the hollow part of the safety plunger may act as a gas port or it may be provided for locking the plunger in a position which leaves the flash chamber in the tee piece open.

Detonator - The detonator has a brass casing. A second pyrotechnic delay tube is spun into the mouth of the casing. For storage each detonator is provided with a bakelite cap which fits over the delay tube.

Operation

The safety wire is withdrawn from the pressure button and the safety plunger. When the pressure button is given a sharp blow, the striker penetrates the igniter cap, and the pyrotechnic train is fired. When the grenade is thrown the safety plunger falls away opening the flash chamber. The first pyrotechnic tube gives a delay of about 4 1/2 seconds and the tube spun into the detonator gives a further delay of about 3 seconds. The grenade is therefore designed to explode in 7 to 8 seconds after the pressure button is actuated.

Remarks

A hand grenade of Danish origin was recently recovered in Italy. There are no markings on the grenade itself to indicate origin, but the carton containing 10 detonators for use in the grenade had a label printed with a crown and the following:

Hærens Ammunitionsarsenal
10 St-K
Tændpatroner
N.1941
Fremstillelseår: 1936
Efter søte og sendrede: 1942

The detonators were apparently made in 1936. The materials and construction of the grenade indicate pre-war production.

GERMAN
SHAVING STICK
GRENADE

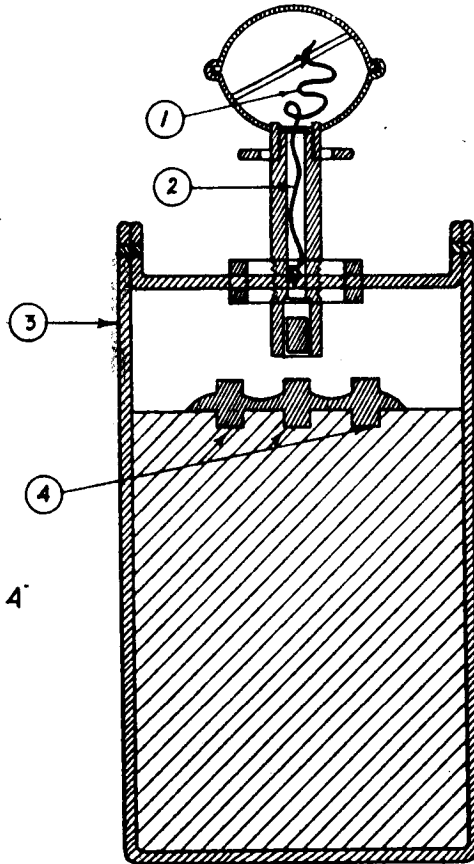
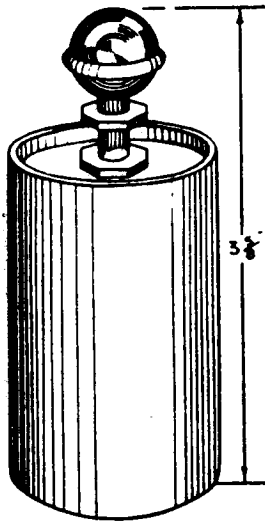

Legend

- 1. Pull Cord
- 2. Friction Wire
- 3. Grenade Body
- 4. Compressed Pellets

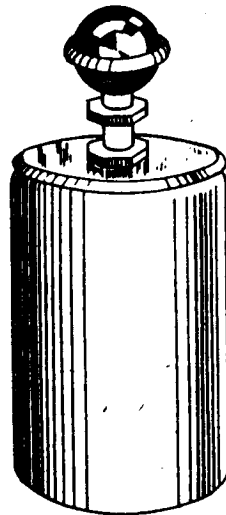

42



GERMAN

SHAVING STICK GRENADE

Data

Overall length 3-5/8 or 4 ins.
Color Body is painted
yellow; the head
of igniter blue.
Maximum diameter 2 inches.
Igniter B.Z.E.
Delay 4 - 5 seconds.

Description

This is a thin-cased "offensive" grenade with the B.Z.E. friction igniter screwed into the top. The body of this grenade is an aluminum cylinder painted yellow. There are two models of this grenade, one being 3-5/8" in length and the other 4" in length.

This grenade may also be used as a booby trap by the insertion of a D.Z. 35 Pressure Igniter.

Operation

The head of the igniter is unscrewed and pulled thus drawing the wire through the friction composition and igniting the delay pellet. The grenade is then thrown and after a 4-5 second delay, the delay element will initiate the detonator.

GERMAN ANTI-TANK MAGNETIC GRENADE
(HAFT HOHL-LADUNG 3kg.)

— LEGEND —

1. MAIN FILLING
2. METAL CONTAINER
3. IGNITER TUBE
4. CLOSING CAP
5. IGNITER THREADS
6. BOLTS
7. PLYWOOD FRAMEWORK
8. MAGNETS
9. BRASS CHAIN

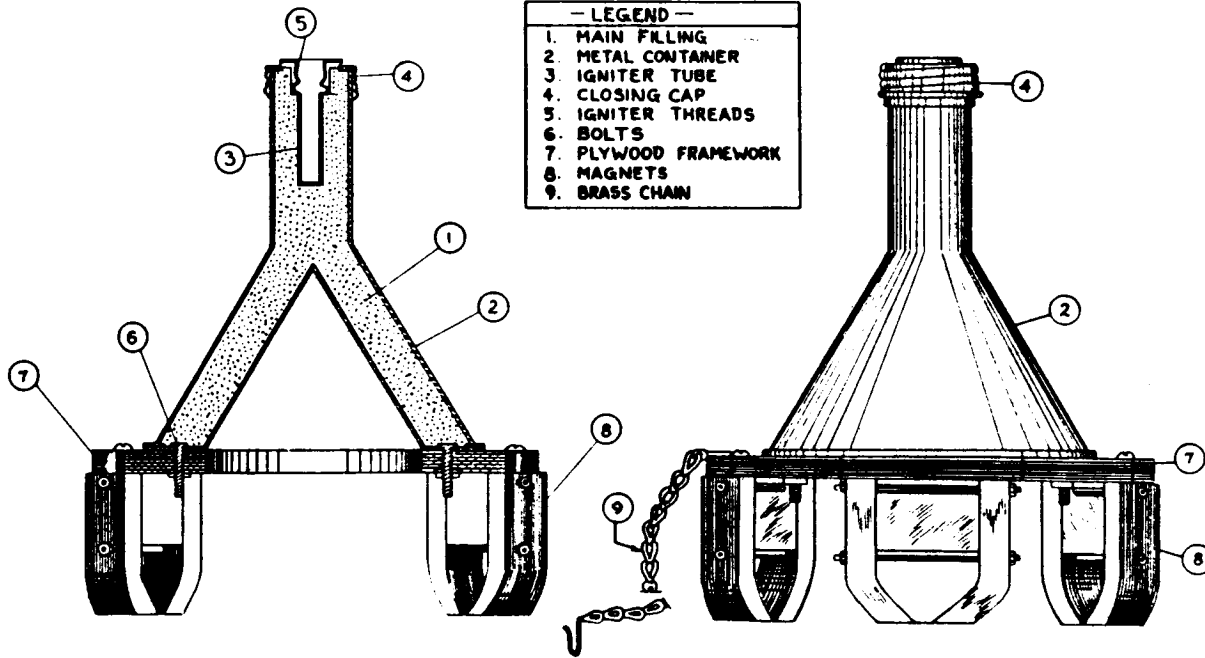



GERMAN

MAGNETIC ANTI-TANK GRENADE

HOFT HOHL LADUNG 3kg.

Data

Overall length	4-3/8 inches.
Maximum diameter	3-1/16 inches.
Color	Field Grey.
Total Weight	7 lbs. 11 ozs.
Filler	RDZ/TNT.
Weight of filler	3 lbs. 5 ozs.
Igniter	B.Z. 24.
Delay	4.5 sec. or 7 sec.

Description

This grenade is painted field grey and is fitted with magnets which are sufficiently powerful to cause it to adhere to a vertical surface. The main filling is contained in a pressed metal container which is conical in shape with an elongated apex serving the dual purpose of forming a hand-grip and accommodating the exploder pellet of PETN/Wax. This latter is housed in a metal tube protruding from the underside of the screw-threaded closing cap. The metal tube is screw-threaded internally to receive the igniter.

Attached to the base of the conical portion by means of six bolts protruding through the container is a plywood framework carrying three horse-shoe type magnets. During transit these magnets are fitted with a keeper which must, of course, be removed before using the charge. A brass chain terminating in a hook is attached to the frame.

This charge is reported to penetrate as much as 110 mm. of armor. The penetration is acquired through the use of the shaped charge formed around the 60 degree angle cone.

There are two igniters used in this grenade: one having a delay of 4 1/2 seconds and the other having a delay of 7 seconds. The first igniter has a blue cap and the second has a yellow cap.

Operation

The friction igniter is pulled and this will ignite the delay element. When the grenade strikes a tank the magnets cause it to cling to the side and at the end of the delay time the igniter will detonate the exploder pellet and main filling.

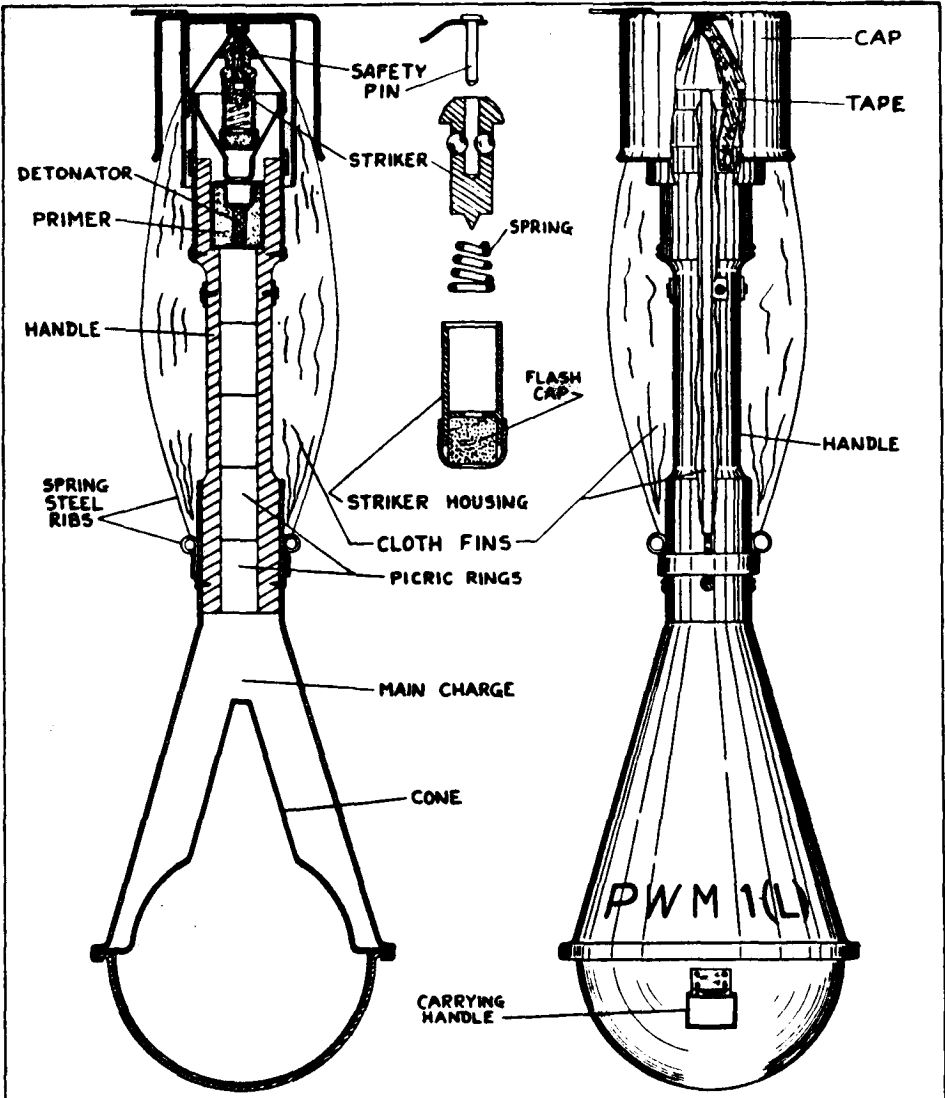

GERMAN
 ANTI-TANK
 GRENADE
 PANZERWURFMINE

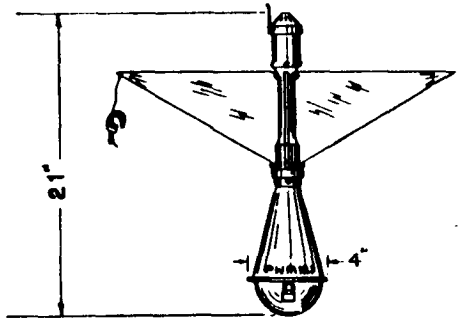



GERMAN

ANTI-TANK

GRENADE

PANZERWURFMINE

Data

Overall length 21 inches.
Length of body 9 inches.
Length of fins 11 inches.
Diameter of body 4-1/2 inches.
Color of body Grey.
Markings P.W.M.1 (L)
Weight 1 kg.
Filling Cast T.N.T.

Description

The grenade consists of a metal body and a wooden handle to which are attached four canvas fins. The fins are held against the handle, before throwing, by a metal cap at the base of the handle. The body is made in two pieces crimped together and attached to the handle by a metal band.

The fuze is located at the top of the handle and consists of a striker which is held away from the primer by a creep spring and two steel balls. The two balls fit into a recess in the striker and are held outward by a safety pin fitting between them, thus causing them to bear against the top of the striker housing and prevent the striker from moving down. Attached to the safety pin is a small length of tape which is held in by the metal cap and a semi-circular clip attached to one fin and fitting around the handle.

Beneath the primer and in the base of the handle is a detonator and a picric acid gain. The main filler is cast around a cone in the body to give a hollow-charge effect.

Operation

Before throwing, the cap over the end of the handle is pulled off and the fins held against the handle.

When the grenade is thrown, the four fins fly out because of their spring ribs. When the clip attached to one fin is pulled away from the housing, this releases the tape which unwinds and pulls the safety pin out of the striker. During flight the safety balls move in freeing the striker which compresses the creep spring on impact setting off the primer, detonator, gain and main filling.

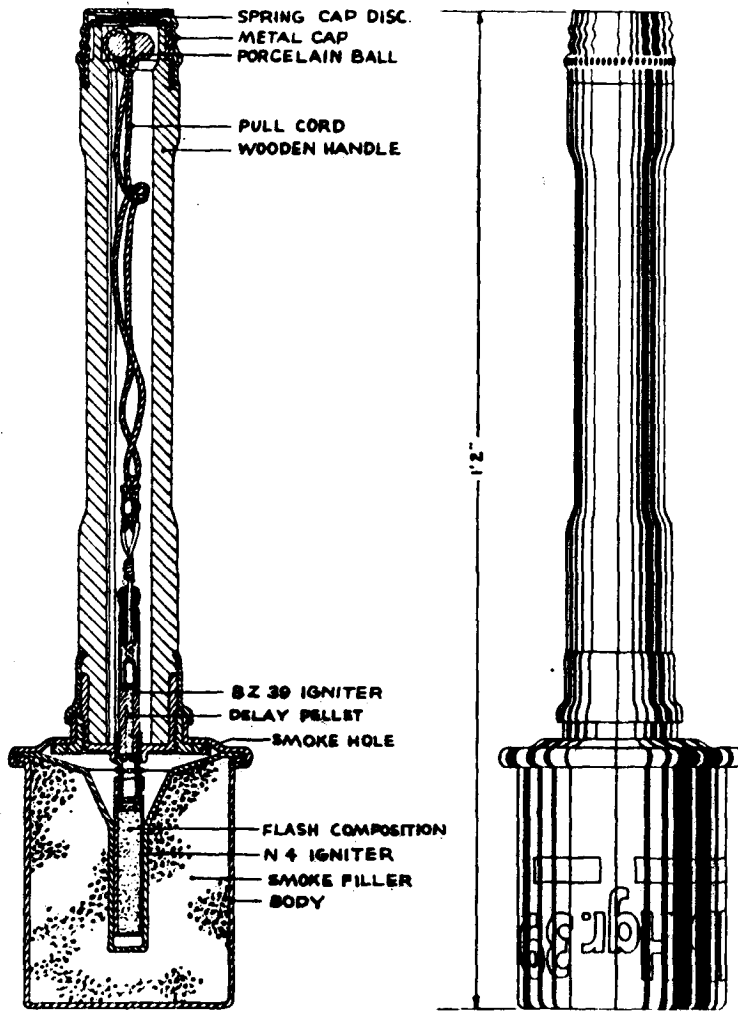

**GERMAN SMOKE HAND GRENADE
MODEL 39**

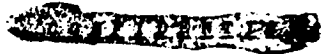

GERMAN

SMOKE HAND GRENADE 39 NABELHANDGRANATE 39

Data

Total Weight 1 lb. 14 oz.
Overall Length 14 inches.
Ignition M.2. 39.
Delay
M4 ignition tube 7 seconds.
Filling (MC) Berger mixture
zinc & hexachlorethane.
Color Olive drab.
Markings White band 8" wide
around center of
handle and lettering No. Hgr. 39 stencilled in white
around the body above a broken white band.

Description

This grenade closely resembles the H.E. stick grenade 24 in external form and size. However, instead of the H.E. filling this grenade is filled with a Berger smoke mixture. There are eight holes in the base of the head through which the smoke escapes. The handle has three horizontal corrugations at the screw cap end to assist in differentiation by touch.

Operation

Insert the friction igniter into the handle and then place the open end of the flesh cap into the recess in the top of the friction igniter, finally screwing the head onto the handle. Then, by removing the screw cap and pulling the igniter, the delay is ignited and the grenade may be thrown. Smoke is emitted for two minutes. Because of the short duration of the smoke, this grenade is used where accuracy in placing a small screen is most important, such as screening machine gun nests and pillboxes.

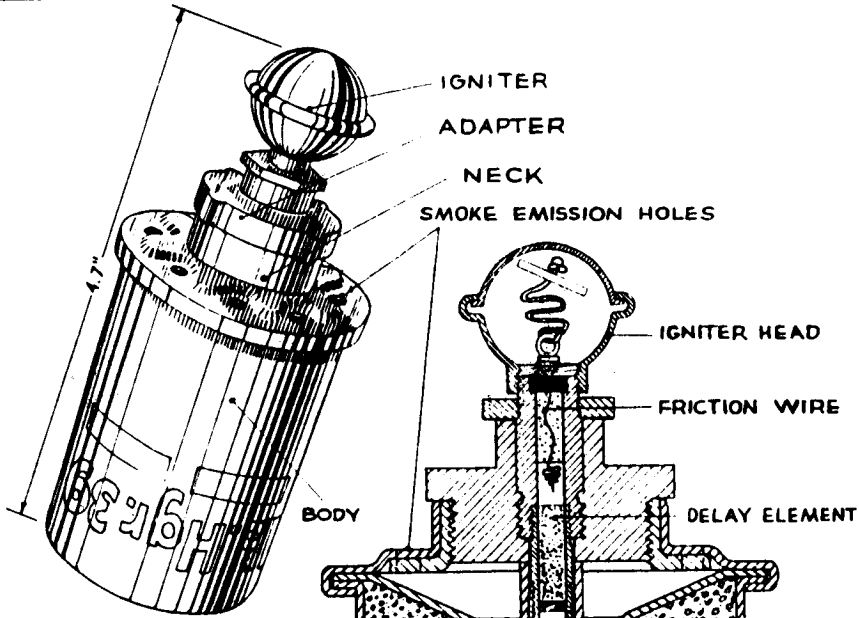

**TYPE 41
PROTOTYPE**

- IGNITION MIXTURE
- FLASH COMPOSITION
- IGNITION TUBE
- SMOKE FILLER

**GERMAN
SMOKE
HAND
GRENADE**

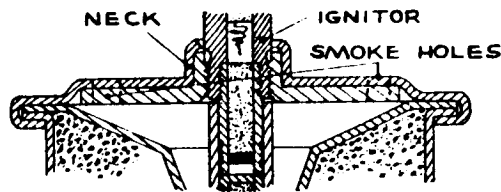

TYPE 41

Data

Overall length 4.7 inches.
Maximum diameter 2.3 inches.
Color Olive drab.
Total weight 21 ounces.
Filling (HC) Berger type
mixture. Zinc &
Hexachlorethane.
Ignition B.Z.E.
Delay
N4 Ignition tube 4 1/2 seconds.

GERMAN

SMOKE HAND GRENADE 41 and PROTOTYPE NABELHANDGRANATE 41

Description (Prototype)

This grenade consists of a body which is the head of the smoke Hand Grenade 39 into which the B.Z.E. igniter is fitted by means of an adapter made of some synthetic resin. The adapter is threaded externally to screw into the neck of the grenade body and internally to receive the igniter. The closed end of the ignition tube is painted green. Nb. Hgr. 39 is stencilled in white over a broken white band around the body. It has the eight smoke emission holes of the Model 39.

Description (Model 41)

This grenade is of the same construction as the Nebelhandgrenate 39 and the Nebelhandgrenate 41 prototype. However, the body has been modified so that the adapter to take the B.Z.E. igniter is not necessary. A dished plate with a small central neck in the top replaces the old wide screw neck plate which required the adapter. There are only two smoke emission holes. The letters Nb. Hgr. 41 and a broken line are stencilled in white on the grenade body.

Operation

The igniter and adapter are removed from the grenade body. The N4 ignition tube is inserted, painted end first, into the central channel of the grenade head. The adapter and igniter are then replaced. The blue painted cap in the igniter is unscrewed and pulled. This functions the igniter. The grenade is then thrown and after the 4 1/2 second delay has elapsed, smoke is emitted through the emission holes for two minutes. Because of the short duration of the smoke, this grenade is used when accuracy in placing a small screen is most important, such as screening machine gun nests and pillboxes.

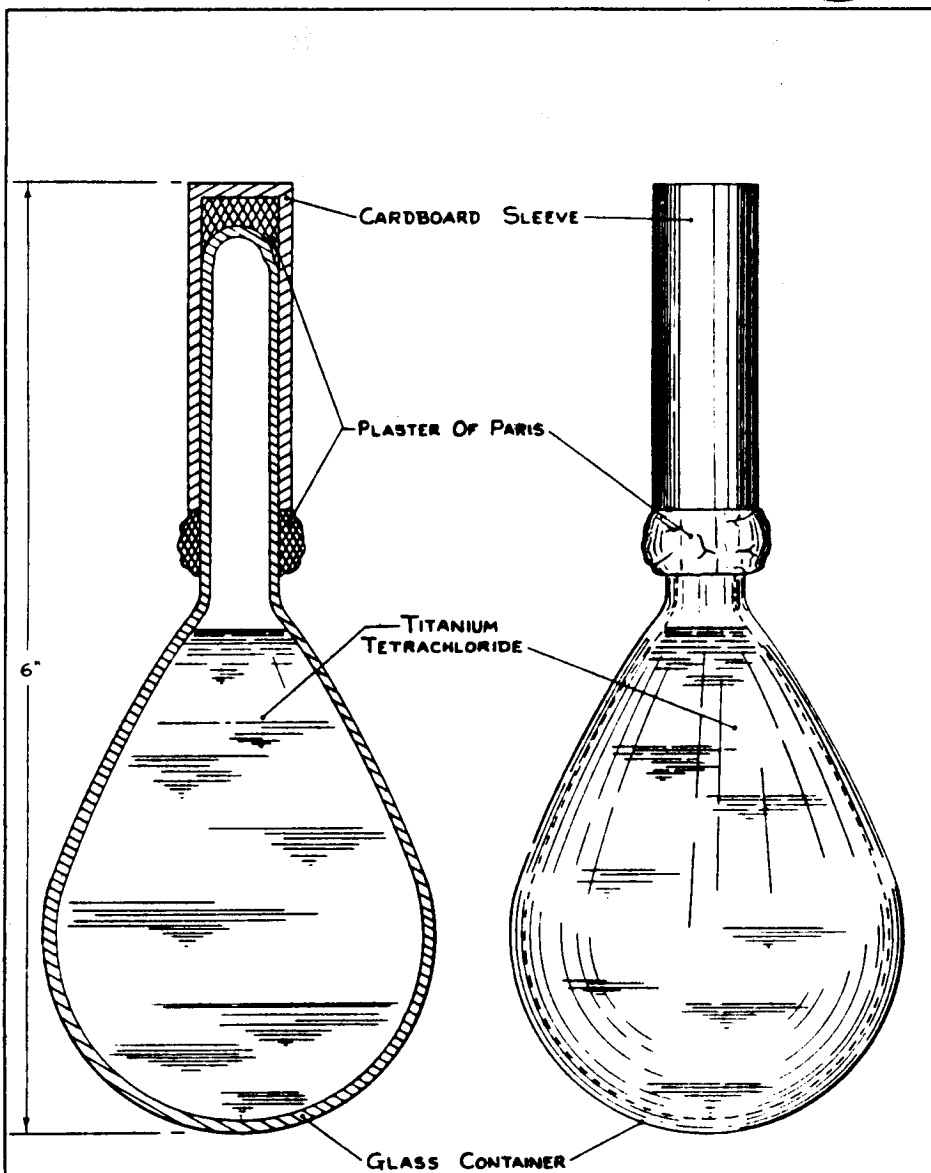

BLENDKORPER 1H
GERMAN SMOKE GRENADE



GERMAN

SMOKE GRENADE BLENDKÖRPER 1H

Data

Overall length 6 inches.
Maximum Diameter 2-1/2 inches
Total Weight 13.2 oza.
Filling (FM) Titanium
Tetrachloride
Weight of filling 10.6 ounces.

Description

This grenade is a tear drop shaped glass flask sealed at the upper end by drawing out the flask. The sealed tip is protected by a cardboard sleeve, sealed with a plaster of Paris type material.

Operation

The munition is used by throwing against a hard surface which breaks the flask. The titanium tetrachloride then vaporizes, forming an effective smoke cloud if relative humidity is high. The smoke cloud is then at low relative humidity.

The grenade is used to produce a small smoke screen to blind the enemy. It is also used to patch gaps in larger screens.

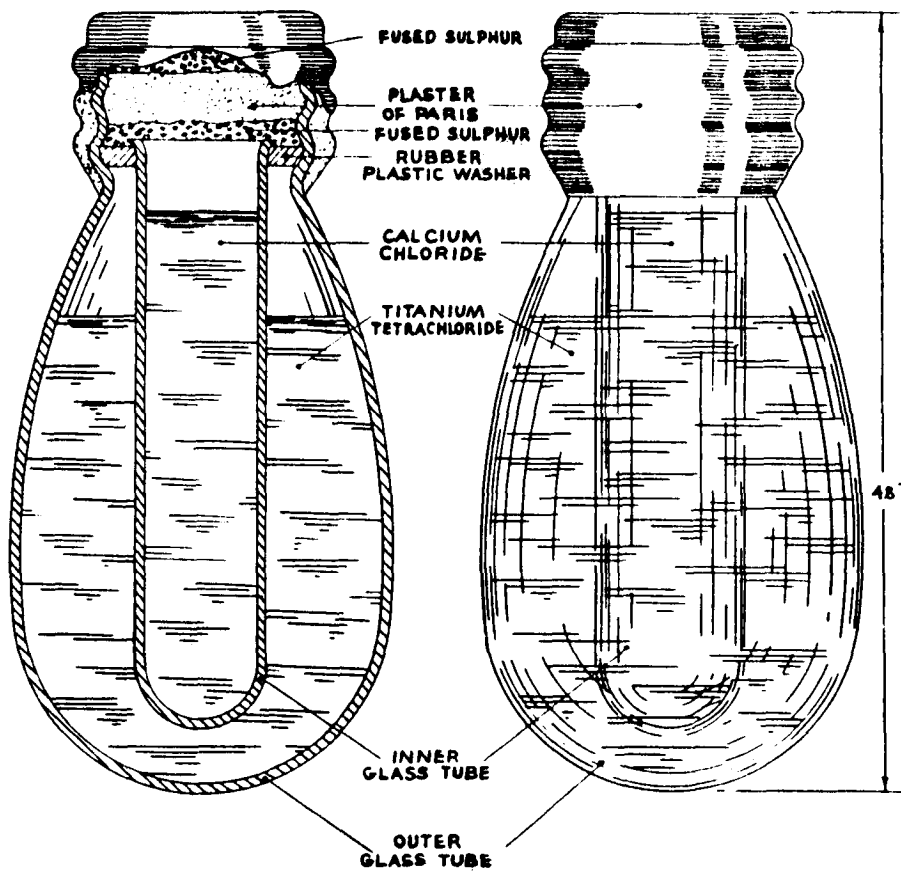

BLENDKORPER 2 H
GERMAN SMOKE GRENADE



GERMAN

SMOKE GRENADE

BLENDKÖRPER 2H

Data

Overall Length 4.8 inches.
Maximum Diameter 2-1/2 inches.
Total Weight 17 ozs.
Filling & Filling Weight
Outer flask 270 grams titan-
ium tetrachloride
Inner flask 36 grams aqueous
solution of cal-
cium chloride.

Description

The grenade consists of an outer glass bulb of molded construction and an inner glass tube which seats and is sealed on the neck of the outer flask. There is a white plastic washer at the junction. The grenade is sealed by a sulphur and cement plug. The solution of calcium chloride is supplied in the inner tube to provide water necessary for the reaction so that the grenade will cause an effective smoke at conditions of low relative humidity. The calcium chloride has probably been added to lower the freezing point of the water. Thus the grenade is practical in a cold dry climate.

Operation

The grenade is thrown and upon impact with a hard object it breaks causing a smoke. It is for use to blind the enemy and also to repair gaps in larger screens.

GERMAN FRANGIBLE INCENDIARY GRENADE



19(a)

GERMAN

**INCENDIARY
GRENADE**



Data

Overall length 10.15 in.
Diameter of bottle 2.85 in.
Total weight 2 lbs.
Filling & Filling wt. 350 grams (approx.
1 pint) of a black
opaque liquid having
a creosote-benzene
odor.
Color & Markings Bottle was of fairly
heavy green glass.
The marking "Feuer-
gefahrlich" (danger
of fire) in red
letters on paper label.
Ignition Two matchhead igniters on side of bottle.

DESCRIPTION:

The grenade consists of a green glass bottle with two igniters fitted into grooves on opposite sides of the body and held in place by two lengths of adhesive tape. The bottle contains a liquid incendiary filling and is sealed with a long, straight sided cork. The bottle had a smooth finish except for the grooves which had a slightly pebbled finish.

The igniters are small railroad fuses provided with a matchhead for ignition. The mixture of one igniter will burn for approximately 40 seconds and shoots out sparks for a distance of 16 inches.

OPERATION

The grenade is functioned by removing the cap from one of the igniters, striking the matchhead, and hurling the grenade at the target. When the bottle breaks on impact, the fuel is ignited by the burning fuse. The extra igniter is furnished in case the other igniter does not function.

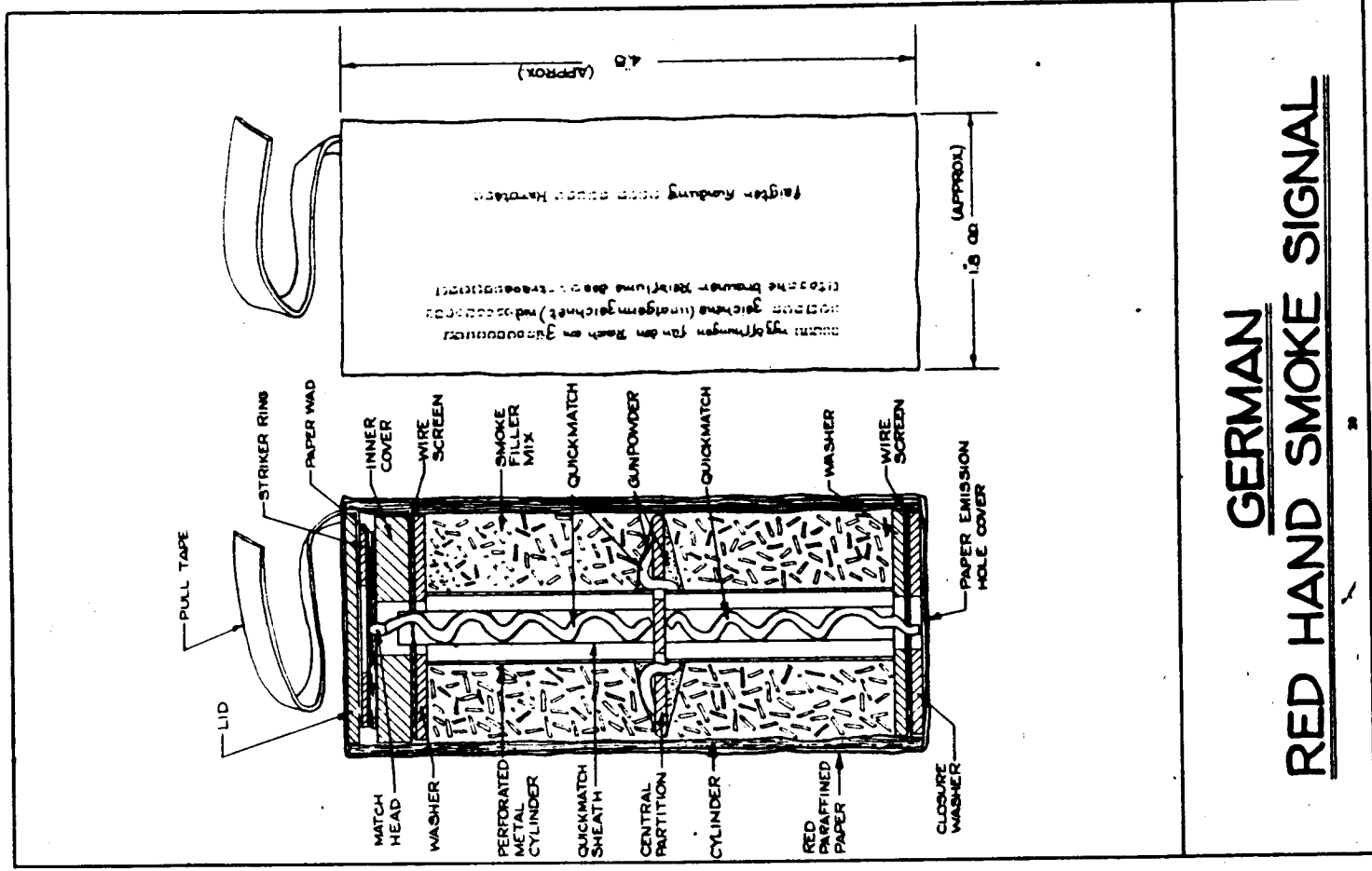

GERMAN
RED HAND SMOKE SIGNAL

GERMAN

HAND SMOKE SIGNAL (RED)

HANDRAUCHZEICHEN - ROT

Overall length 4.9 inches.
Maximum diameter 1.8 inches.
Total weight 4.4 ozs.

Filling:

Red dye-ortho methoxy
phenylazo - naphthol 55%
Potassium chlorate 20%
Lactose 10%
Unidentified light
oily material 15%
Total weight of filling 54.0 grams.
Ignition Match head -
striker.

Description

This signal is included as an example of many German colored smoke signals. It is a cardboard cylinder with a cardboard pull tape lid at the fuze end and a glued in cardboard disc with an emission hole at the other end. The whole signal is wrapped in red paraffined paper upon which the name and instructions are printed. Beneath the pull tape lid is a cardboard striker ring, one half the top side of which is coated with a red phosphorus abrasive mix. A paper wad separates this and the match head. Beneath the match head is a cardboard inner cover and a wire screen. A perforated metal cylinder containing the quickmatch sheath is partitioned in the middle by a cardboard disc which is impregnated with gunpowder and has two diametrically opposite holes in it. At the emission end is another wire screen and the cardboard disc with a tissue paper covered emission hole.

Operation

By striking the striker ring on the match head the quickmatch is ignited. This burns its entire length and ignites the gunpowder disc which is in direct contact with the inflammable smoke mixture. Smoke is then emitted at both ends of the cylinder. The signal may be placed or thrown. Its primary purpose is as a signal from the ground to an air observer.

Remarks

German smoke signals numbers 350, 160, and 80 which are orange are analogous to this signal but differ in some respects. There are also similar signals in yellow and violet.

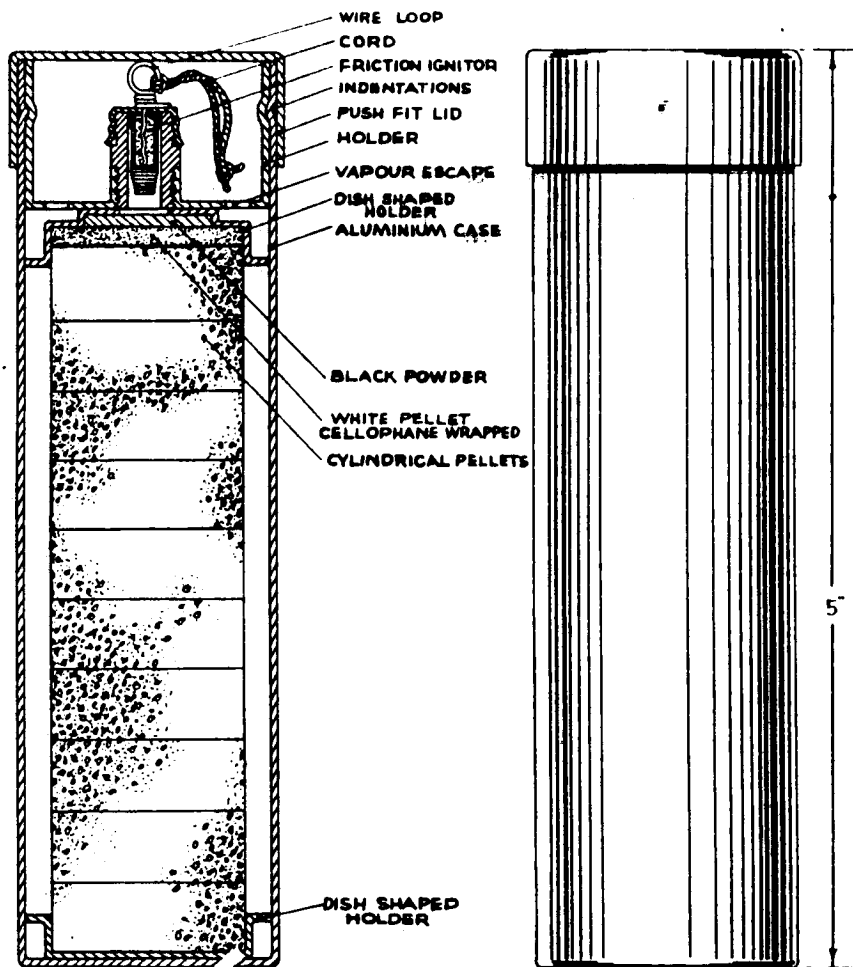

GERMAN LACHRYMATORY GRENADE

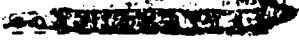

Data

Overall length 5 inches.
Maximum diameter 1 1/2 inches.
Color Aluminum.
Filling C.A.P.

GERMAN

LACHRYMATORY

GRENADE

Description

The case is made of thin sheet aluminum. Within the case, below the lid is a cylindrical holder retained in position by four indentations in the case which correspond to four indentations in the holder. This holder has a screwed projection to take the friction igniter. The latter has a short piece of cord, 10 cm. in length attached to a wire loop. Below the holder is a dish shaped aluminum piece which contains a small compressed charge of black powder. On the upper side of this charge is a thin disc of white powder. The main filling consists of ten cylindrical pellets of a yellow compound and one pellet of a white substance wrapped in cellophane. The charge is held between the two dish shaped pieces. The grenade generates a lachrymatory vapor when ignited and the vapor escapes through the holes in the holder. The containers are unpainted aluminum, and the lid is secured by a piece of adhesive tape colored blue. They are safe to handle when the lids are in place. To disarm the grenade, the igniter may be unscrewed from the holder, taking care not to twist the wire in so doing.

Operation

The lid is removed and the friction igniter is pulled. The vapor will be emitted through the holes in the holder.

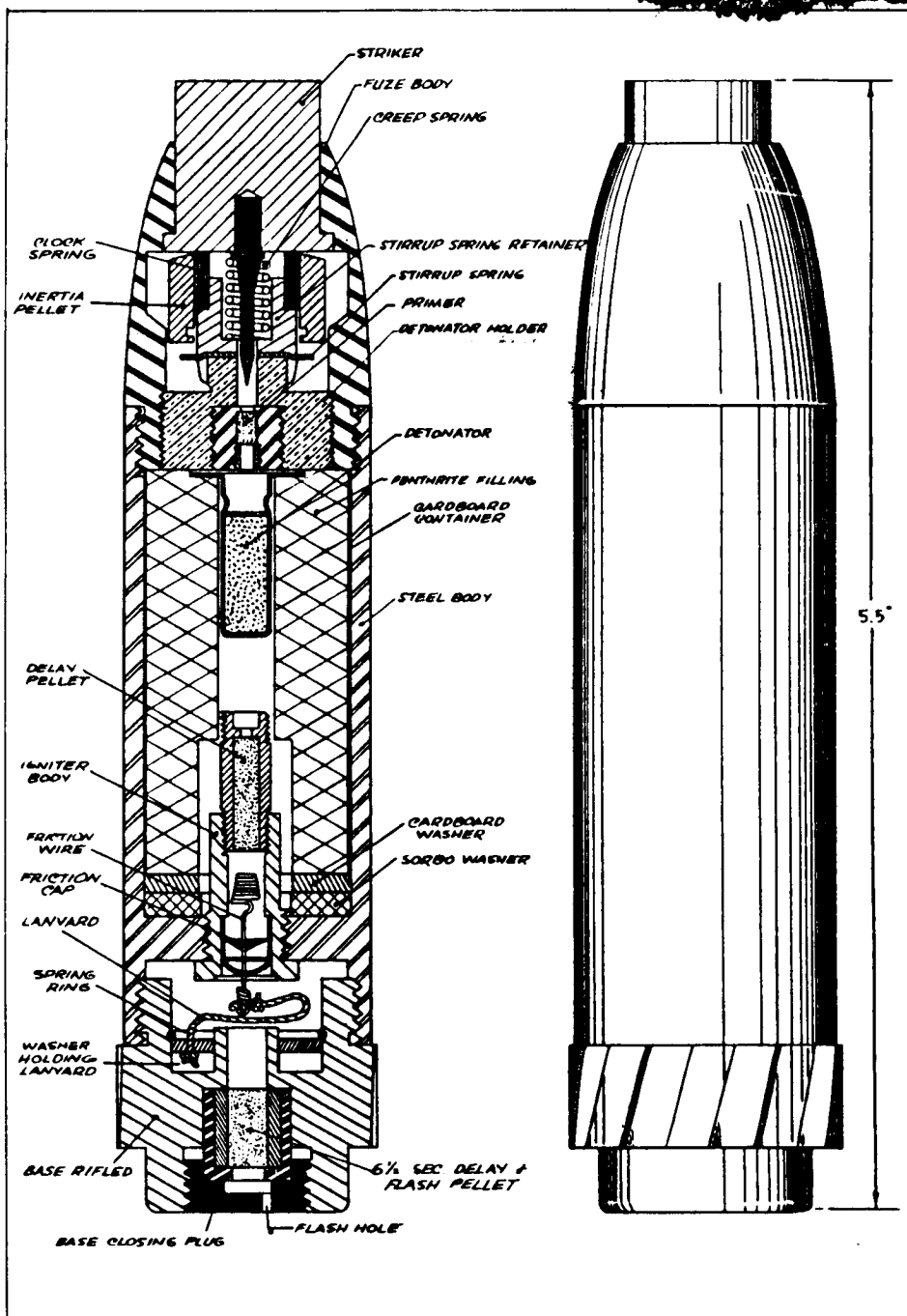

GERMAN ANTI-PERSONNEL RIFLE OR HAND
 GRENADE. -(GEWEHR-SPRENGGRANATE.)



GERMAN

ANTI-PERSONNEL RIFLE OR HAND GRENADE GEWEHR-SPRENGGRANATE

Data

Overall length 5.5 inches.
 Maximum diameter 1.2 inches.
 Color Black body. Aluminum fuze & base.
 Total weight 9 ozs.
 Explosive filler PETN/Wax.
 Weight of filler 1.1 ozs.
 Maximum Range 550 yards.
 Delay Self-destroying
 - 11 seconds.
 Friction Igniter
 - 4½ seconds.

Description

This grenade consists of a body with explosive filling and detonator, a fuze body carrying the direct action fuze, a friction igniter, and a base fitment carrying the delay of the self-destroying system.

The body is in the form of a steel tube having a diaphragm near the bottom. It is screw threaded at the nose to receive the fuze body and at the base to receive the base fitment. The diaphragm is screw threaded centrally to receive the delay igniter.

The filling is penthrate wax contained in a cardboard container. The explosive has a central cavity which holds the detonator encased in an aluminum container at one end, and receives the igniter delay pellet from the diaphragm at the other end.

The fuze is made of aluminum and is of the direct action type. The base of the fuze body is threaded externally to enter the grenade body and internally to receive a detonator holder. It consists of a striker held away from the primer by a creep spring and a coiled spring. Around the coiled spring is an inertia pellet resting on four fingers of a stirrup spring fixed in the base of a stirrup spring retainer. The inertia pellet has a groove cut on the inside of it.

The friction igniter which is similar to the B.2.24 used with stick hand grenades screws into the central channel of the diaphragm. The igniter pellet has a delay of 4-1/2 seconds.

The rifled base fitment is screw threaded externally to screw into the base of the grenade and internally at the base to receive a closing plug. A 6½ sec. delay pellet contained in a brass holder is situated in the base.

The propelling cartridge is a 7.92 mm. cartridge closed at the shoulder by crimping. The propellant consists of 0.9 gram of nitrocellulose flakes.

Operation

1. As a Rifle Grenade -
 - a) On discharge the inertia pellet of the fuze is driven downwards and the ends of the stirrup spring are forced into the grooves of the inertia pellet thus holding it down. The clock spring is now held in position by the collar of the striker pin and the stirrup spring retainer. On deceleration the clock spring flies outward, assisted by centrifugal force, into the recess in the fuze body. On impact the striker compresses the creep spring and penetrates the primer whose flash explodes the detonator.
 - b) Should the fuze not function the grenade will be self-destructive. On firing the flash enters the hole in the closing plug and ignites the delay pellet which burns for 6½ seconds. This then fires the friction igniter which will give an additional delay of 4½ seconds and then fire the detonator.
2. As a Hand Grenade -
 - a) The base fitment is unscrewed and the cord of the friction igniter pulled. This gives a delay of 4½ seconds and then fires the detonator.

SMALL GERMAN Atk RIFLE GRENADE (Gewehr Panzergranate)

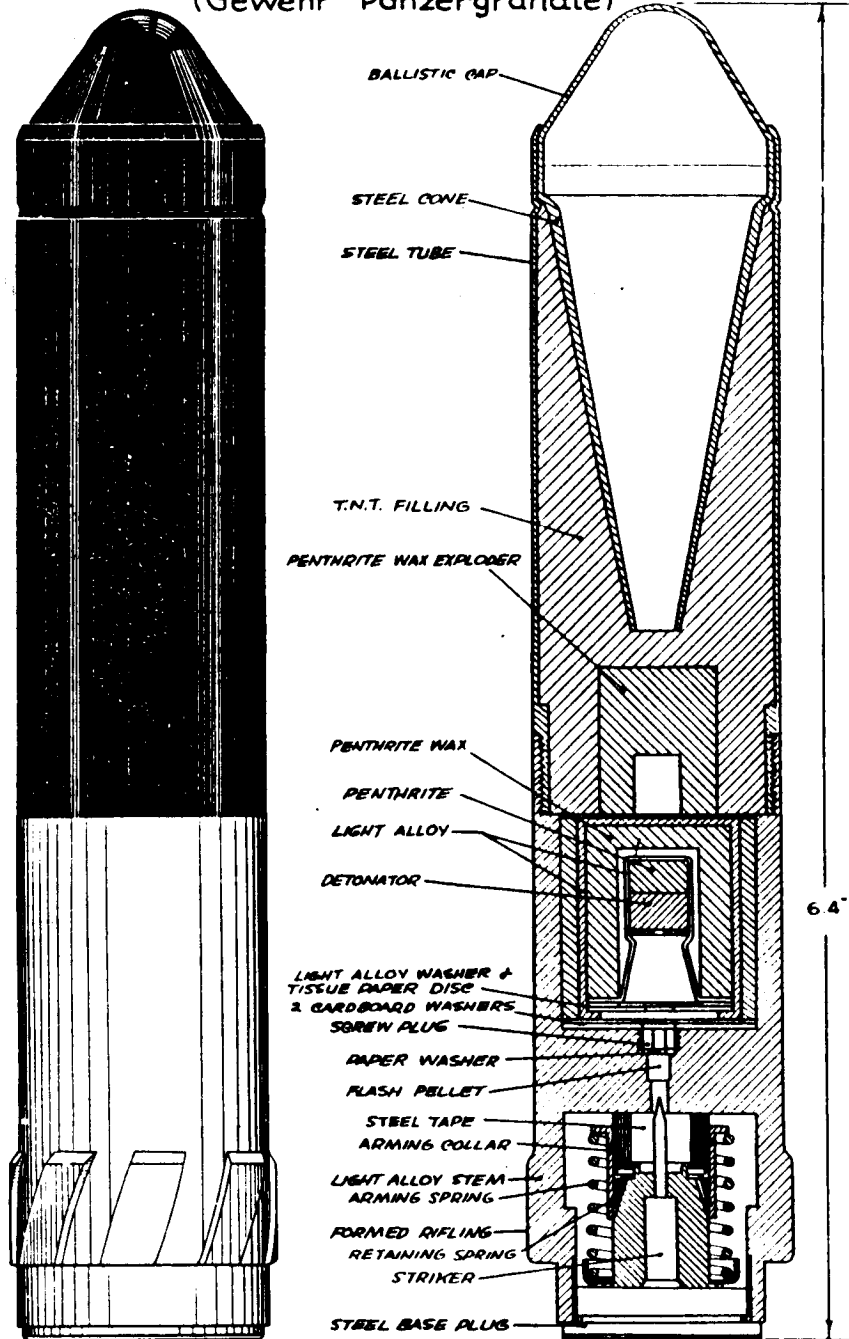

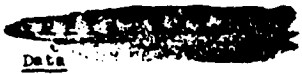

Data

Overall length 6.4 inches.
 Maximum diameter 1-3/16 inches.
 Color Front half is
 black and back
 half is aluminum.
 Total weight 8.8 ounces.
 Filler T.N.T.
 Weight of filler 1.75 ounces.
 Range 50 yards.

GERMAN

ANTI-TANK

RIFLE GRENADE

GEWEHR PANZERGRANATE

Description

This grenade is fired from the rifled 3 cm. discharger cup (Schlessbecher) which can be fitted to most types of German rifles. It is constructed in two parts, the head and the stem. The head is a seamless steel tube with the forward portion containing a hollow charge cone and the explosive filling, being closed at the forward end by a light ballistic cap. The main filling of T.N.T. is poured around the cone and there is a cavity formed in the after part of the main filling in which the exploder of penthrate wax is inserted.

The stem is made of light alloy or aluminum and is screwed onto the head of the grenade. The stem is divided into two compartments, the lower containing the fuze, the upper the gaine. In the septum is a small flash pellet held in place by a perforated screw plug. The gaine consists of a light alloy case into which is inserted a light alloy top hat containing the detonator, the space between being filled with penthrate wax. A pre-engraved driving band is formed around the stem 6 mm. from the rear.

The fuze is in the after portion of the stem and consists of a striker over the top of which fits a retaining spring with four prongs bent downward into grooves in the striker body. Around the striker body is an arming collar which has two grooves cut on the inside. An arming spring is compressed between a lip on the arming collar and a second collar at the bottom of the striker body. Around the inside of the arming collar and resting on the striker body is a steel tape which acts as an additional safety device and prevents any possibility of the fuze being accidentally armed when screwing on the base plug.

The entire assembly is closed by a base plug which positions the fuze by a stem which fits into a recess in the rear of the striker body.

Operation

On firing, the shock of discharge causes the arming sleeve to set back against its spring. The four prongs of the retaining spring are forced out of the lower groove in the arming sleeve and engage in the upper groove, retaining the arming sleeve in its lower position. This allows the steel tape to unwind and the striker is then free to move forward on impact firing the gaine.

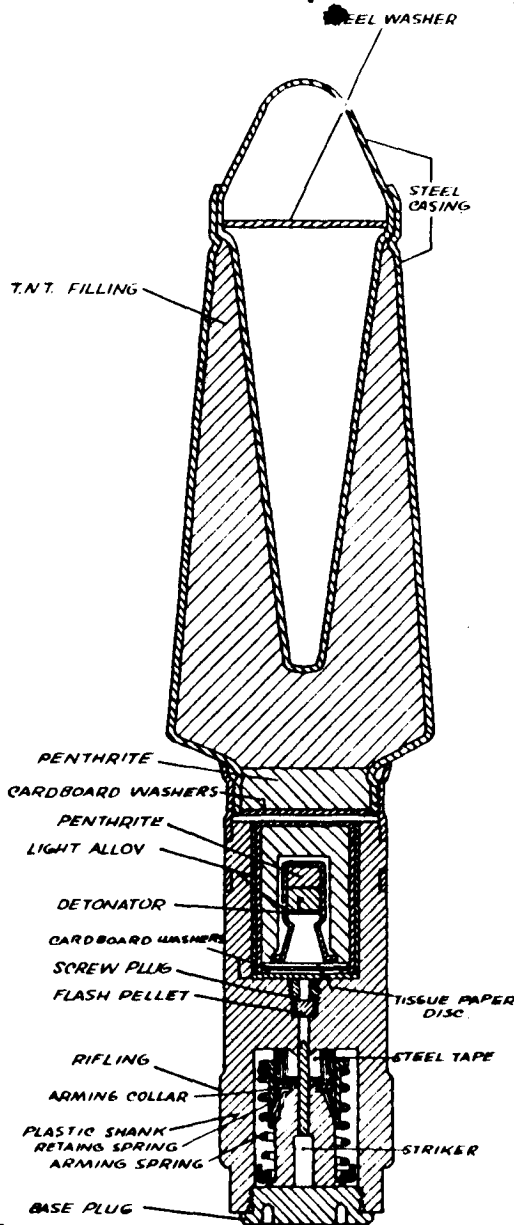
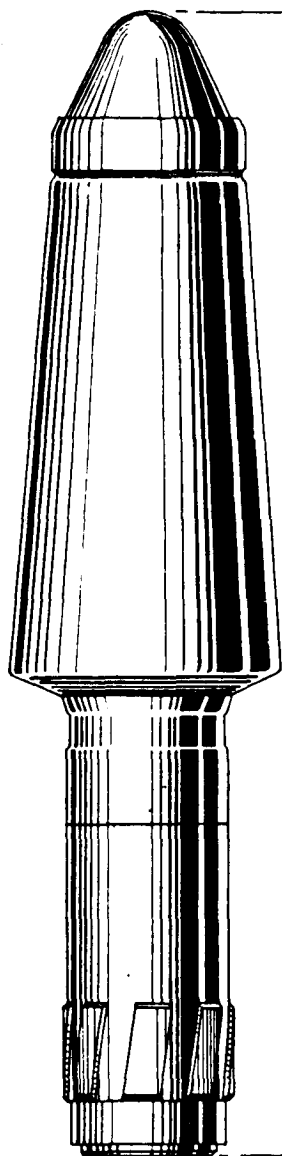

LARGE GERMAN ATK RIFLE GRENADE
 (Gross Gewehr Panzergranate)



GERMAN

LARGE ANTI-TANK RIFLE GRENADE GROSS GEWEHR PANZERGRANATE

Data

Overall Length 7 inches.
Maximum diameter 1-3/4 inches.
Color Black overall.
Total weight 13-1/2 ounces.
Weight of filler 4-1/2 ounces.
Filler T.N.T.
Range 100 yards.

Description

This grenade is fired from the rifled 3 cm. discharger cup (Schies-becher) which can be fitted to most types of German rifles. It is of the hollow charge type and consists of a steel head containing the explosive and a light alloy or steel and plastic stem containing the fuse and gaine. The propelling cartridge contains a wooden bullet.

The body which is of pressed steel contains a steel cone around which the main filler of T.N.T. is cast. A steel washer with a small central hole rests on the open end of the cone and above the latter is a steel ballistic cap. At the bottom of the T.N.T. is an exploder pellet of penthrite wax.

Two varieties of the stem have been found, one entirely of light alloy, the other of plastic with a steel shank by which it is screwed on to the head of the grenade. At the base of the stem is a rifled band which corresponds with the rifling in the discharger cup. The stem is divided into compartments by a perforated septum, the lower containing the fuse, the upper the gaine. In the septum is a small flash pellet held in place by a perforated screw plug. The gaine consists of a light alloy container into which is inserted a light alloy top hat containing the detonator, the space below being filled with penthrite wax.

The fuse is in the after portion of the stem and consists of a striker over the top of which fits a retaining spring with four prongs bent downward into grooves in the striker body. Around the striker body is an arming collar which has two grooves cut on the inside. An arming spring is compressed between a lip on the arming collar and a second collar at the bottom of the striker body. Around the inside of the arming collar and resting on the striker body is a steel tape which acts as an additional safety device and prevents any possibility of the fuse being accidentally armed when screwing on the base plug.

The entire assembly is closed by a base plug which positions the fuse by a stem which fits into a recess in the rear of the striker body.

Operation

On firing, the shock of discharge causes the arming sleeve to set back against its spring. The four prongs of the retaining spring are forced out of the lower groove in the arming sleeve and engage in the upper groove, retaining the arming sleeve in its lower position. This allows the steel tape to unwind and the striker is then free to move forward on impact firing the gaine.

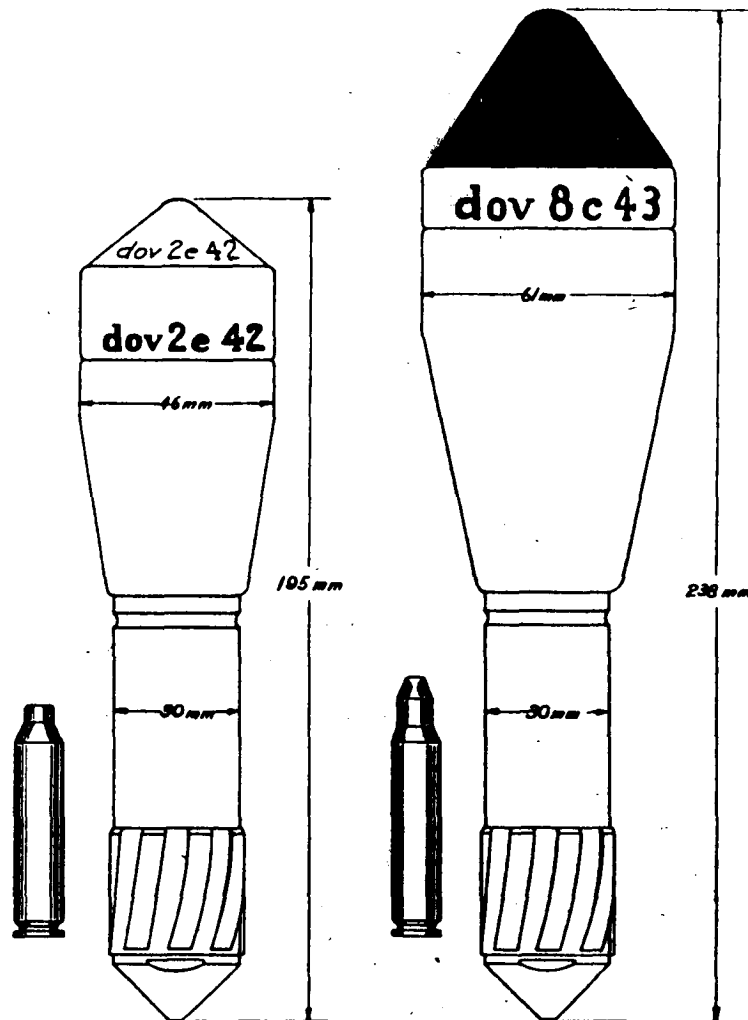

S.S. GEWEHR
PANZERGRANATE 46

S.S. GEWEHR
PANZERGRANATE 61

**GERMAN HOLLOW CHARGE
RIFLE GRENADES**



**GERMAN
HOLLOW CHARGE
RIFLE GRENADE**

**S.S. GEWEHR PANZER-
GRANATE 61MM.**

DATA

OVERALL LENGTH 9.4 in.
DIAMETER OF HEAD 2.4 in.
LENGTH OF STEM 4.0 in.
DIAMETER OF STEM 1.2 in.
WEIGHT 19.0 oz.

PROPELLING CARTRIDGE This consists of a lacquered steel cartridge case, the extended neck of which encloses a small wooden pellet. The cap is uncolored.

DESCRIPTION

This consists of a streamlined unpainted phosphated steel body closed at the head by a conical black pressed steel impact cap. The stem is of steel and has the normal pre-rifled section to correspond with the rifling of the discharger cup. The base plug is conical and is provided with two screw flats. Grenade fired from standard discharger cup (Schlesbecker).

**GERMAN
HOLLOW CHARGE
RIFLE GRENADE**

**S.S. GEWEHR PANZER-
GRANATE 46 MM.**

DATA

OVERALL LENGTH 7.7 in.
DIAMETER OF HEAD 1.8 in.
LENGTH OF STEM 4.0 in.
DIAMETER OF STEM 1.2 in.
WEIGHT 18 1/2 oz.

PROPELLING CARTRIDGE The round consists of a lacquered steel 7.92 mm. cartridge case crimped at the neck and sealed with wax. The cap is yellow.

DESCRIPTION

This has an unpainted phosphated streamlined body of smaller dimensions than the 61 mm above, and is closed by a conical unpainted steel impact cap. The stem is identical in external appearance with the larger grenade.

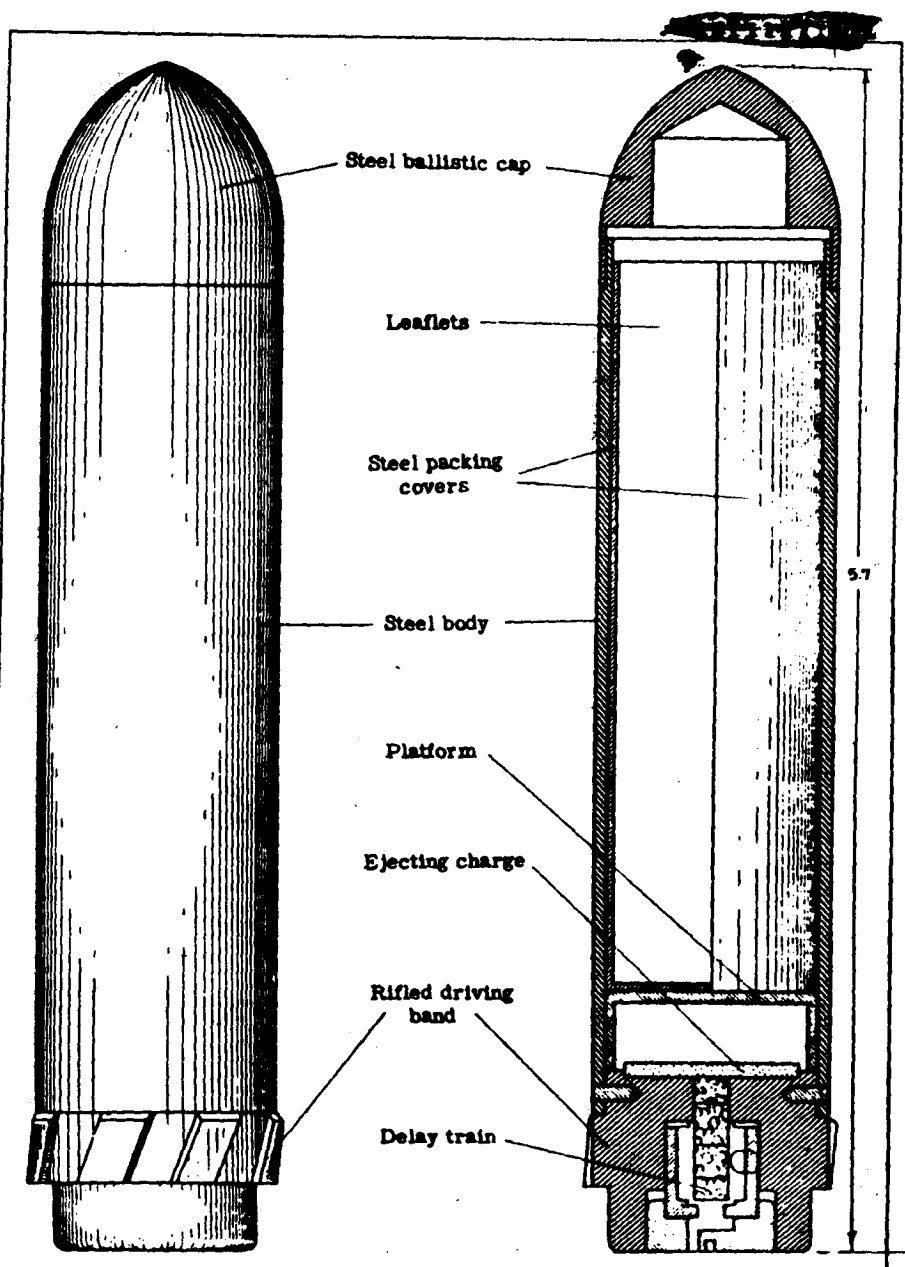

**GERMAN PROPAGANDA
RIFLE GRENADE**



GERMAN

PROPAGANDA

RIFLE GRENADE GEWEHR PROPAGANDA GRANATE

Data

Overall length 5.7 inches.
Total Weight 8 oss.
Weight without leaflets 7 oss.
Delay 9 seconds.
Range 500 yards.

Description

This grenade is fired from the rifled 3 cm. discharger cup (Schleissbecher) which can be fitted to most types of German rifles. The body of this grenade is a steel case with a pre-rifled base. Inside the base there is a 9-second delay fuse and an ejecting charge for the pamphlets. Two steel leaflet packing covers are held loosely inside the case and fitting over the top of these is a removable steel cap. The leaflets are inserted by removing the steel cap and rolling the leaflets tightly making sure that they do not show above the rim of the case. The cap is then replaced.

The case and cap are varnished to protect them from rust and the ejecting charge is protected by a cardboard disc to prevent moisture from causing deterioration.

The propelling cartridge is distinguished from other rifle grenade cartridges by a red ring around the base.

Operation

When the grenade is fired the propelling cartridge will ignite the delay fuse.

Approximately 9 seconds after discharge, the delay fuse will set off the ejecting charge, blowing off the cap and forcing the leaflets out the nose.

31(a)

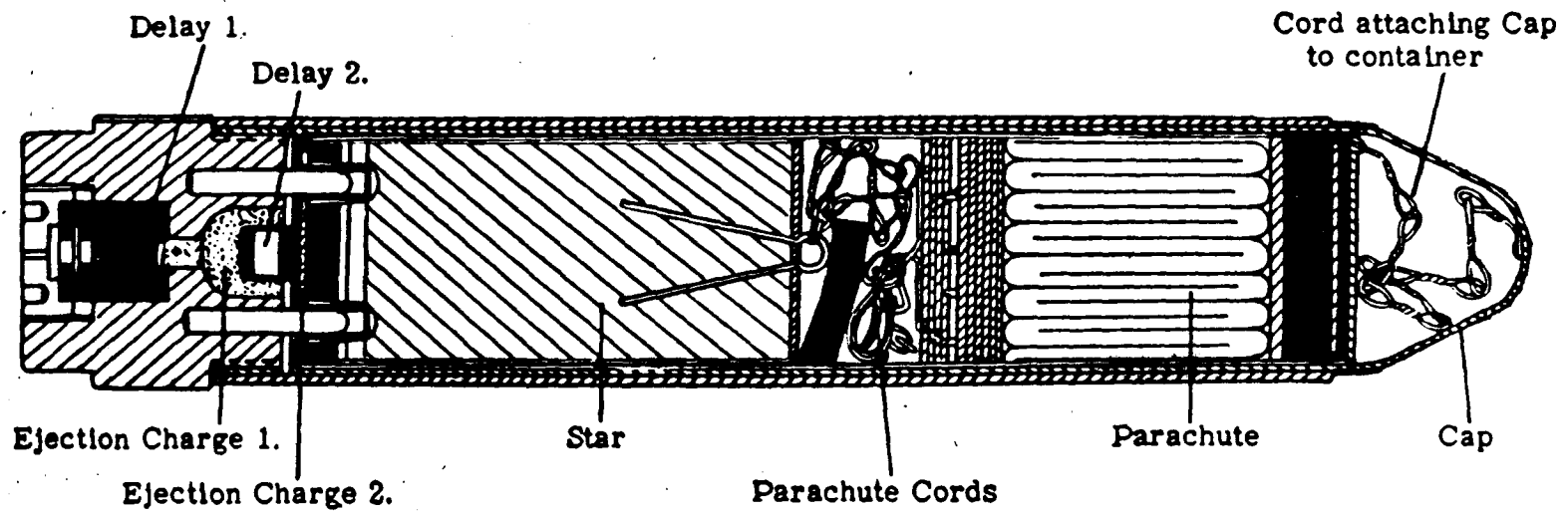

GERMAN ILLUMINATING RIFLE GRENADE.

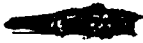

Data

Length 6.88 in.
 Diameter 1.18 in.
 Weight280 gms.
 Color & Markings White cap.
 "Gewehr Fallschirm-
 leucht granate"
 stencilled on body.
 Propellant 1.5 gm. propellant
 enclosed in a cartridge
 case which is closed
 with a wooden bullet.

GERMAN
 ILLUMINATING STAR ON
 PARACHUTE RIFLE GRENADE

**GEWEHRFALLSCHIRM-
 LEUCHTGRANATE**

(GW.F.S. LI GR)

Operation

On firing, delay 1 is ignited by the flash from the propellant gases. After 6.5 seconds of flight, ejection charge 1 is initiated. This ejects the container holding the star and parachute. At the same time, delay 2 is initiated. During this part of the flight, the cap hangs from the container by means of a cord. After delay 2 has burned through (2 seconds), ejection charge 2 is initiated and the parachute and star ejected. It is stated that distances up to 650 meters may be illuminated.

Remarks

Each grenade is packed together with a propellant charge in a cardboard container.

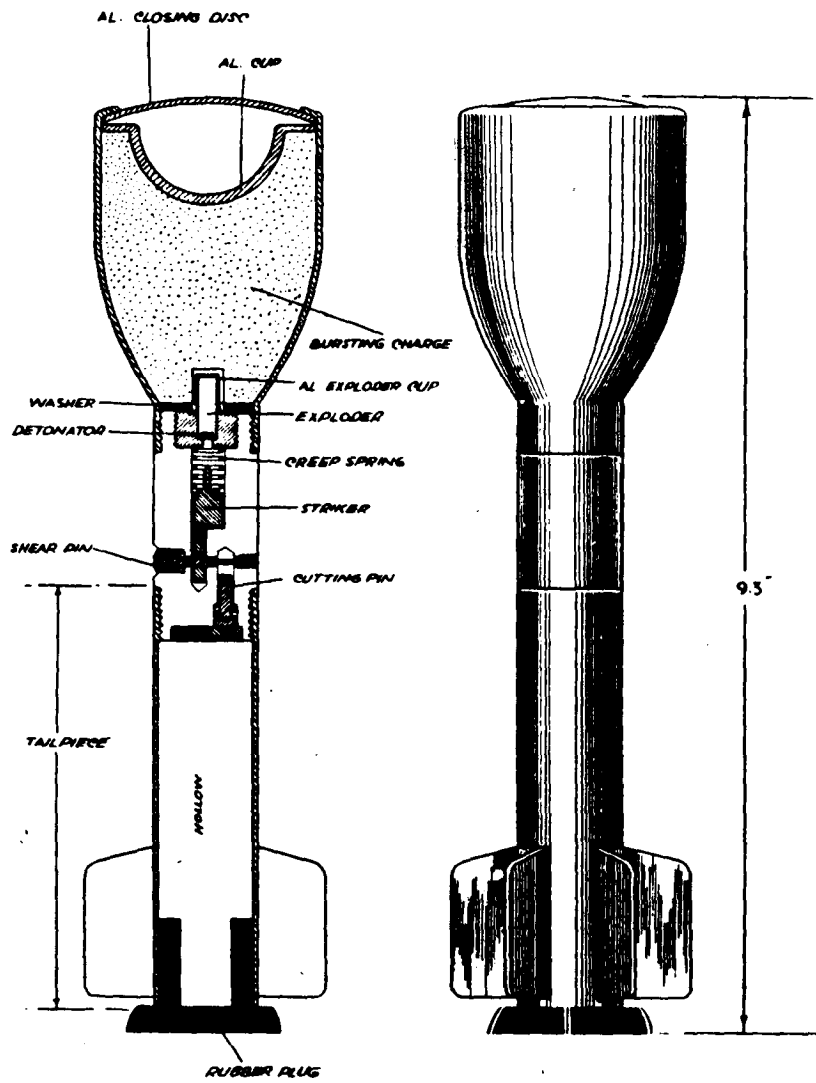

HOLLOW CHARGE GRENADE
 (SCHUSS Gg. P.40)

GERMAN

HOLLOW CHARGE

GRENADE

SCHUSS Gg. P-40

Data

Overall length 9.3 inches.
Maximum diameter 2.4 inches
Color Olive green.
Markings Blue band
round projection at the
base of body.
Length of body 3.1 inches.
Filler Cyclonite/Wax

Description

The grenade consists of a streamlined bell-shaped body, with a slightly convex closing disc of aluminum, a graze fuze which screws into a projection on the base of the body, and a vaned tail unit which screws on the base of the fuze and is closed by a rubber plug.

The body is made of thin steel and is streamlined with a cylindrical projection welded at the base. The projection is screw-threaded internally for the insertion of the fuze. A hole in the base of the body is fitted with an aluminum cup to accommodate the protruding magazine of the fuze. The head of the body is closed by a concave disc of aluminum which is secured by the overturned rim of the body.

The bursting charge consists of cast cyclonite-wax with a hemispherical cavity in the head. The cavity is fitted with an aluminum liner of corresponding shape with a flange which fits inside the body at the head.

The fuze is cylindrical with an external screw-thread at each end for assembly as the connecting piece between the tail unit and the body. A central recess contains the striker and creep spring and is closed at its enlarged front end by an aluminum magazine which is screwed in and contains a detonator and an intermediary explosive. A transverse channel near the base contains a spring-loaded screwed shearing pin which engages in a recess in the stem of the striker. Another channel containing a cutting pin with spring, is bored from the base of the body and communicates with the shearing pin at a point where the shearing pin is reduced in diameter. A circular plate, secured in a recess in the base of the body by two screws, retains the cutting pin in its channel. The base end of the cutting pin passes through a hole in the circular plate and is thus exposed to the pressure of the propellant gases.

The tail unit screws on to the base of the fuze and consists of a drawn-steel tube with six vanes formed in pairs. The cartridge is placed inside the tube for transport and the tube is closed at the base by a rubber plug.

The cartridge is of the 7.92 mm small arm type with an undyed hollow wooden bullet.

Operation

The grenade is fired from the spigot type discharger. On firing the hollow wooden bullet is shattered by the propellant gases, which project the grenade. The propelling gases overcome the spring of the cutting pin and drive the pin forward, causing it to cut the shearing pin away from its screwed end. The shearing pin is then ejected by the spring held in compression under its head, and thus leaves the striker held off the detonator only by the creep spring. On graze the momentum of the striker overcomes the creep spring and the detonator is pierced.

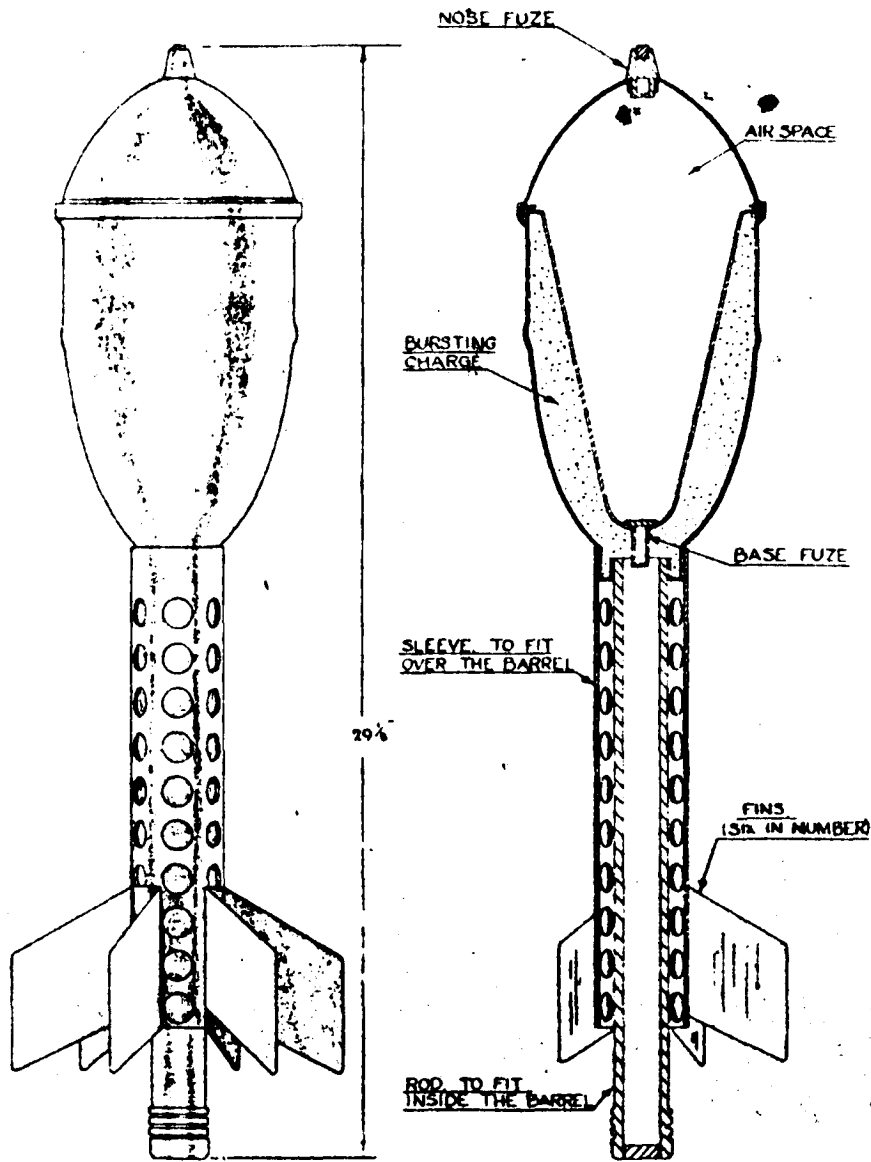

**GERMAN 37-MM
 A/T STICK GRENADE**

GERMAN

37 MM. H.E. ANTI-TANK STICK GRENADE

Data

Overall length 29-1/8 inches.
Length of stick 16-7/16 inches.
Length of body 12-1/4 inches.
Total weight 18 lbs. 12 oz.
Weight of filler 5 lbs. 6 oz.
Explosive filler Dinitro aniline
with T.N.T.
Base Fuse Bd.Z. 5130
Point Fuse A.Z. 5075.

Description

The complete round, which is made up of the hollow charge stick grenade and the propellant, is fired from the 3.7 cm. P.A.K. gun.

The stick grenade has a steel rod which fits into the bore, and a concentric perforated sleeve which fits around the barrel of the gun. A pressed steel cap forms the nose of the grenade giving it the required standoff distance. The hollow charge is at the rear of the steel cone and consists of two blocks of dinitro aniline with T.N.T. Two detonators are set in the base of the grenade, one facing in each direction. A nose fuse of the instantaneous percussion type and a tail fuse also instantaneous are present.

The steel rod which fits into the bore of the gun is a hollow tube closed at the base end. The base fuse is a percussion type fuse very sensitive to shock. It is armed by setback which releases a spring loaded detent allowing a steel ball to move away from the striker. Upon impact the striker moves forward against the action of a very weak creep spring.

The nose fuse consists of a striker held away from the primer by a creep spring and a coiled spring. Around the coiled spring is an inertia pellet resting on four fingers of a stirrup spring fixed in the base of a stirrup spring retainer. The inertia pellet has a groove cut around its internal circumference.

Two detonators are located in the base of the main charge. One detonator faces toward the nose fuse to receive the flash from there, and the other detonator faces the tail fuse to receive its flash.

The propelling charge is contained in a steel cartridge case. The charge consists of diethylene glycol dinitrate tubular stick powder with an igniting charge of nitrocellulose granular powder, and a percussion type primer consisting of mercury fulminate and black powder.

Operation

On discharge the inertia pellet of the nose fuse is driven downwards and the ends of the stirrup spring are forced into the grooves of the inertia pellet thus holding it down. The clock spring is now held in position by the collar of the striker pin and the stirrup spring retainer. On deceleration the clock spring flies outward, assisted by centrifugal force, into the recess in the fuse body. At the same time the base fuse is being armed. In the event of direct impact the nose fuse will function the grenade, but in the event of glaze action, the base fuse will function the grenade.

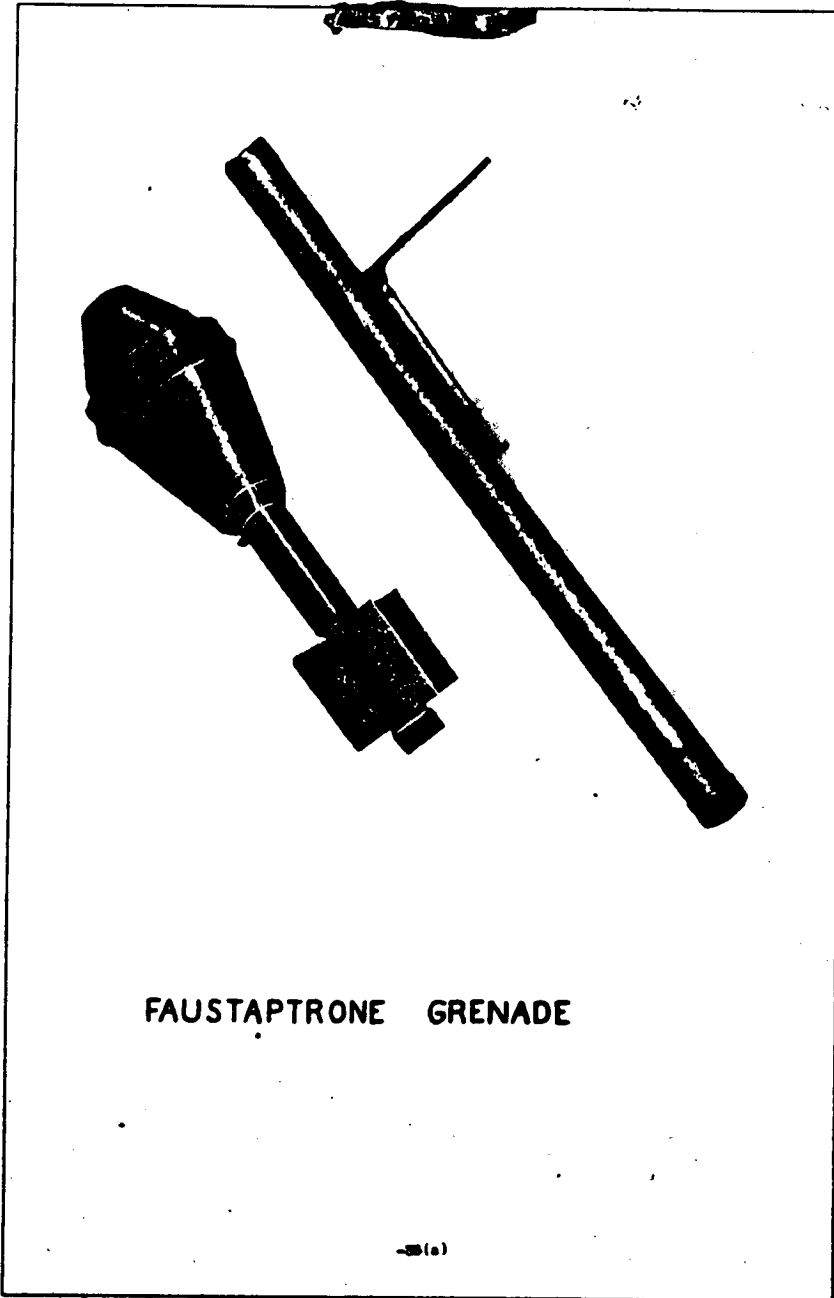

FAUSTPATRONE GRENADE

-5(a)

- (1) Get Fusepatrone to "Fire" only when using. The Fusepatrone can be set to safe again if it has not been fired.
- (2) To set from "Fire" to "Safe," turn bolt to vertical, then push fully forward and hold. Press release button and allow it to slide back slowly so that firing pin spring is allowed to expand. Snap right back into tube and replace split pin.
- (3) On discharge, a sheet of flame up to 6 feet long comes from the rear end of the tube. Great care must be taken that the flame and bits of wadding do not hit either the fire or anyone standing behind him. The danger zone extends up to 30 feet. There must be a clear space (i.e. no earth, stones or wall) for the flame at least 6 feet behind the tube.
- (4) If propellant charge falls do not attempt to fiddle around with the weapon. It must be laid aside carefully and exploded. Delayed explosions may still occur. Should the hollow charge detonator fail to explode, the grenade must on no account be touched but must be exploded by placing an explosive charge against it.
- (5) During practice firing with live ammunition in area of 500 yards round fire and target must be closed off. Firing must wear steel helmet.

SAFETY PRECAUTIONS

To make ready for firing the lock is rotated 90° to the left. The tube is held under the right arm, the left hand supporting the forward part. Aiming is accomplished by aligning the sight, placed vertical to the tube. The sight is adjustable for a range of 50 yards. To fire, depress the release button, thus allowing the striker to go forward. The tube cannot be used a second time. The firing mechanism is cocked by pushing the lock forward until the release button engages. The lock then slides back to its original position. The weapon is now cocked and at "safe".

The grenade is armed by unscrewing the tail and inserting the booster and fuse, open ends facing each other. The tail is then replaced. The pressure is trapped around the tail and the grenade inserted into the tube. The pressure position.

The fuse against the inside of the tube serves to retain the grenade in position.

OPERATION

This is a simple metal tube in which is located a propellant charge contained in a waxed cardboard container held in position by a set screw. On the opposite side to the set screw is an igniter attached below a flash hole. On top of the tube is a simple firing mechanism with release button, firing pin and spring and a safety catch. There is also a folding sight.

(2) Projectile

This consists of a large head and a cylindrical body terminating in a tail to which are attached four spring steel stabilizing fins. The body contains a base fuse and a booster.

(1) Grenade

The Fusepatrone consists of a large hollow charge in grenade and a projecting tube.

DESCRIPTION

OVERALL LENGTH	41 in.
LENGTH OF TUBE	31.5 in.
LENGTH OF BODY	19.5 in.
CALIBER OF TUBE	1.75 in.
WEIGHT OF GRENADE	6.65 lbs.
WEIGHT OF TUBE & GRENADE	11 lbs.
WEIGHT OF FUSE	3.4 lbs.
WEIGHT OF FUSE	3.4 lbs.
WEIGHT OF FUSE	3.4 lbs.

GERMAN
HOLLOW CHARGE
GRENADE
FAUSTPATRONE

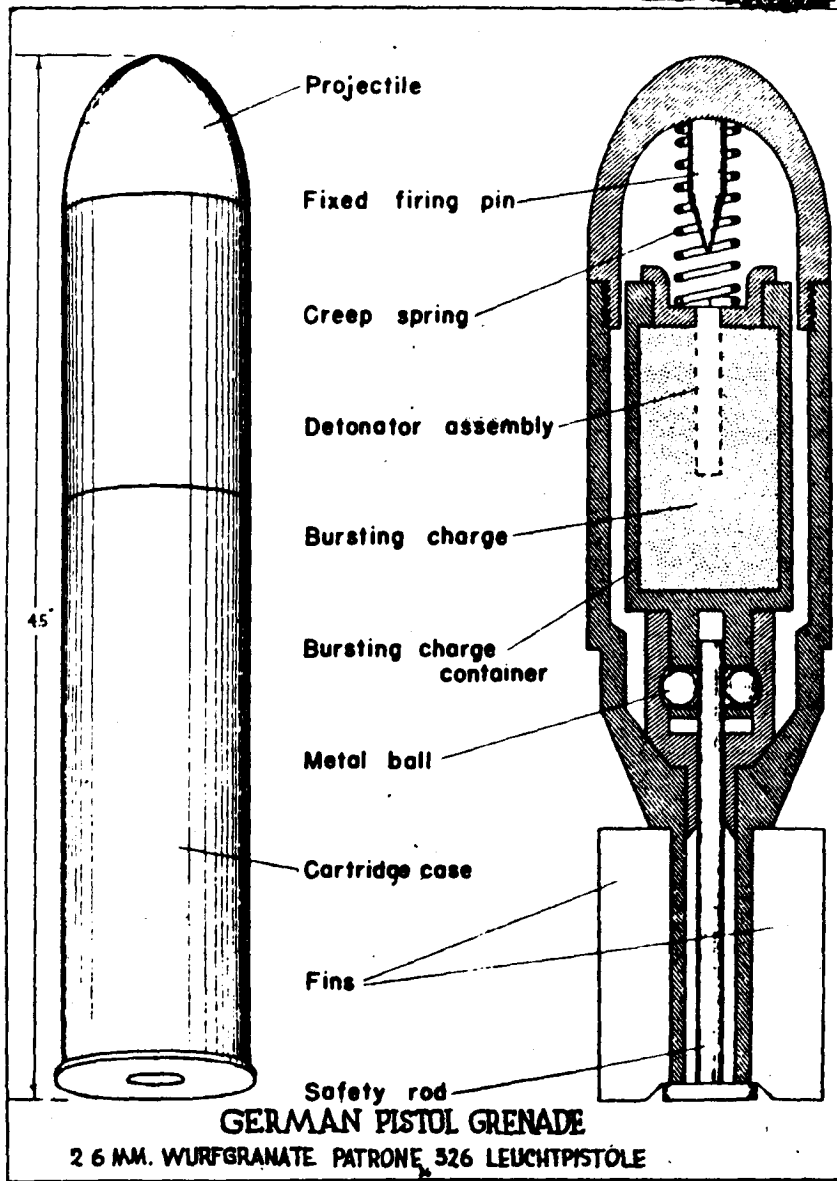

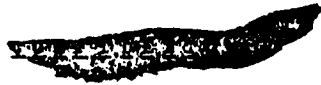

Data

Overall length 4.5 inches.
Maximum diameter 1 inch.
Color Yellow.
Weight of complete round 4.2 ozs.
Weight of projectile 3.2 ozs.
Filler T.N.T.
Weight of filler 7 grams.

GERMAN

PISTOL

GRENADE
26 MM. WURFGRANATE PATRONE
326 LEUCHTPISTOLE

Description

This grenade consists of a projectile having the appearance of a miniature mortar shell and a brass cartridge case. The two parts are crimped together.

The grenade itself is constructed in two parts: the nose cap and the body. The nose cap is rounded and screws into the body of the grenade. Within the body is a case containing the detonator and main filling. Between the case and the fixed firing pin in the nose cap is a creep spring. The case is prevented from moving forward before firing by two metal balls fitting into a hole in the base of the carrier and resting in grooves in a platform in the body. An arming rod fits between the balls holding them out. On the base are four fins which have the same diameter as the body. Contained in the cartridge case which fits over the after part of the grenade is about .1 ounce of rifle powder.

Operation

On firing, the arming rod will be forced out the base by setback. This will happen after 10 - 12 yards of flight and the grenade is then armed. When the rod falls out the balls will move in and the case is free to move forward except for the creep spring. On impact, the case moves forward and the detonator moves onto the fixed firing pin thus exploding the grenade.

PISTOL GRENADE

(WURFKORPER 361 LEUCHTPISTOLE)

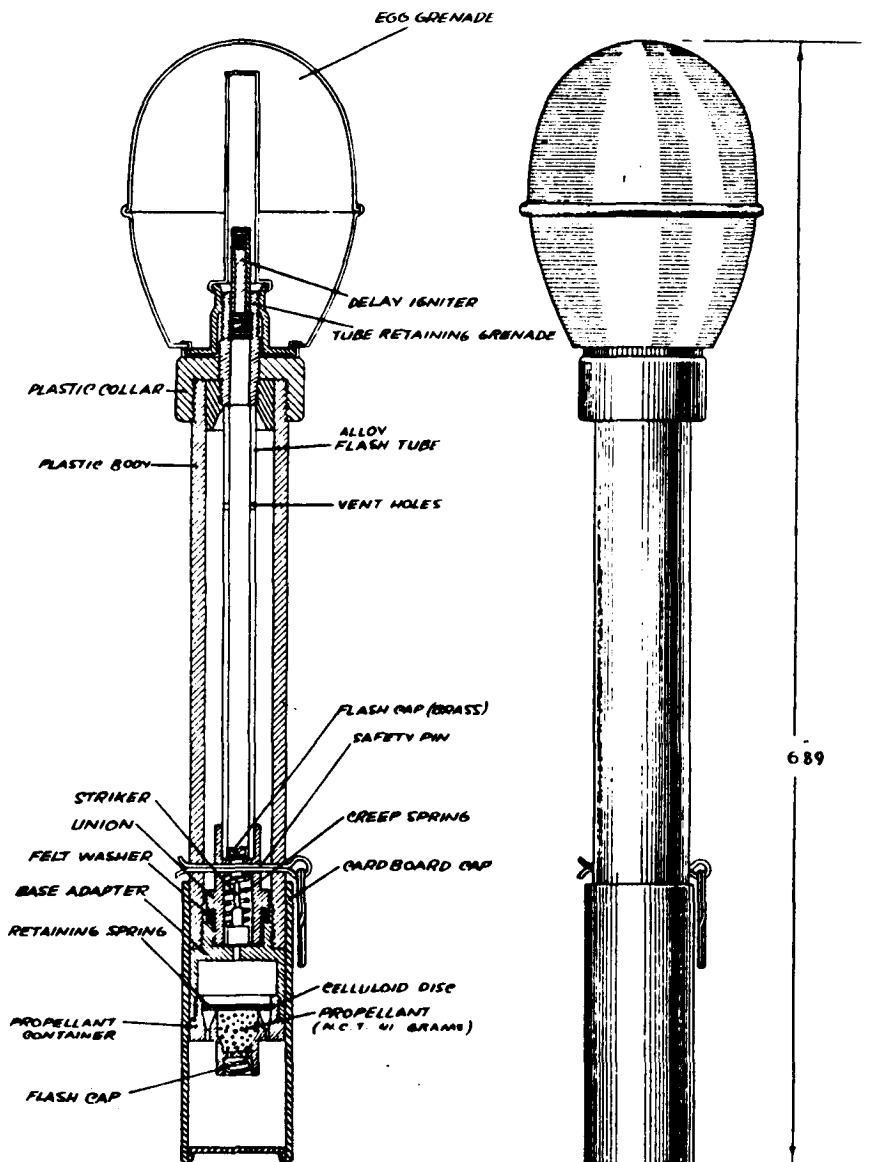



GERMAN

PISTOL

GRENADE WURFKORPER LEUCHTPISTOLE

Data

Overall length 6.89 inches.
Maximum Diameter 3 inches.
Color Olive Green.
Delay 4.5 seconds.
Range 80 yards.

Description

This grenade is fired from the 27 mm. Weither Signal Pistol. It consists of the normal egg-hand grenade attached to a plastic stem or body by a retaining tube. The plastic stem contains the firing pin, delay igniter, detonator, and a base adapter for the propelling charge. The end of the stem is closed before firing by a cardboard cap.

The retaining tube fits through the hollow stem and is threaded to it. The retaining tube is also threaded to the grenade body and contains in its forward part the 4.5 second igniter. In the base of the tube is a fuse consisting of a firing pin held away from the primer by a creep spring and safety pin. An alloy flash tube connects the primer to the delay igniter.

Screwed into the base of the plastic stem is a base adapter containing a primer and propelling charge.

Operation

Before firing the safety pin is pulled out and the grenade is then armed. The stem is placed in a barrel reinforcing tube which is inserted previously in the barrel of the pistol. On impact the firing pin overcomes the creep spring and impinges the primer thus igniting the delay igniter which will detonate the explosive after a delay of approximately 4.5 seconds.

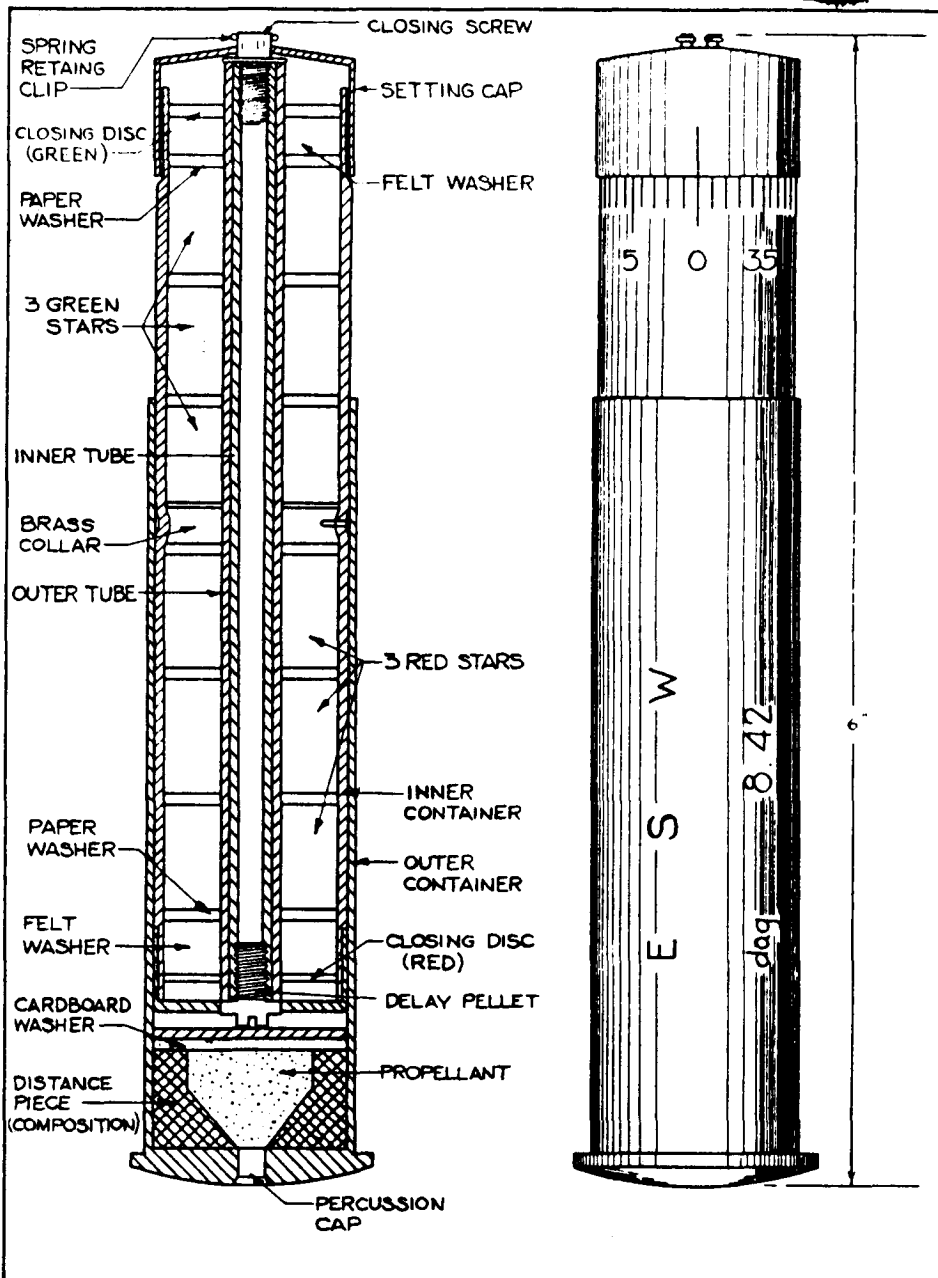

**GERMAN 27 MM
MULTI-STAR SIGNAL CARTRIDGE**

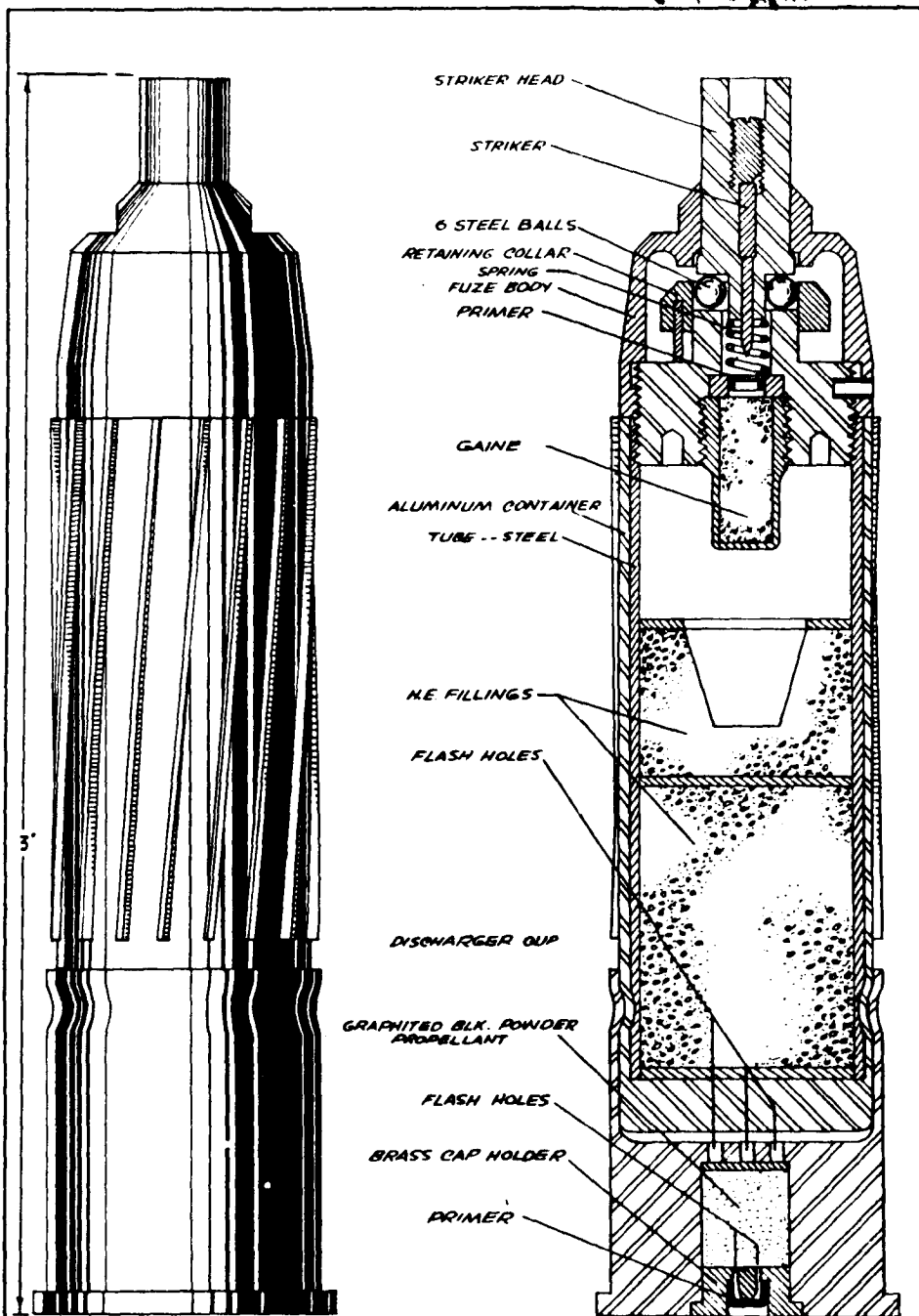

GERMAN
H.E. CARTRIDGE for 27^{mm} (1 in.) GRENADE PISTOL
Sprengpatrone für Kampfpistole



GERMAN

HE. CARTRIDGE FOR 27^{mm} (lin) GRENADE PISTOL SPRENGPATRONE FÜR KAMPFPISTOLE

Data

Overall length	3 inches.
Color	Unpainted aluminum.
Weight of complete round	5 ounces.
Weight of projectile	3-1/2 ozs.
Filler	PETN/wax.
Weight of filler	339 grams.
Propellant	Graphited black powder.

Description

This grenade consists of a die cast aluminum container which encases a steel tube containing the explosive. The fuze screws to the steel tube and the tube and aluminum container are secured by knurling and indents. The propellant charge is contained in a cup which has a push fit to the grenade with 10 holes in the cup to lead the gases to the base of the grenade.

The grenade has 5 grooves making one quarter turn in the length of the projectile, grooved on the aluminum body. The steel liner is threaded internally to take a nose percussion fuze. The explosive filler consists of two penthrate wax pellets separated by cardboard discs.

The fuze is a direct action type and is fitted with a protruding striker head. The striker is held away from the primer by six steel balls which rest in a groove in the striker and on a platform of the fuze. These balls are kept in position by a steel collar which is supported on three aluminum pins. There is also a creep spring between the striker and the primer. Beneath the primer there is a gaine contained in an aluminum case and consisting of Lead Azide and Lead Styphnate in the upper part and PETN in the lower part. Between the gaine and the main filling there is an empty air space.

The discharge cup is a push fit with the base of the grenade which is turned down to fit into the cup. The cup has in its base a Lead Styphnate primer contained in a brass holder. Forward of the cap is the propelling charge of black powder and 10 holes to lead the gases to the base of the grenade.

Operation

On firing, the propelling charge propels the grenade and it rotates because of the rifling on the body. On setback the collar in the fuze moves back crushing the aluminum pins and because of centrifugal force the balls then fly outward, freeing the striker which is kept off the primer by the creep spring. On impact, the striker impinges the primer setting off the gaine and main filler.

German Rifle Grenade Propelling Cartridges

Cartridge for	German Name	Powder Filling Nz.T.P. (1.4;2;0,5/0; 25) grams	Marking	Used only by	Remarks
1. Large A.P. Grenade	G.Treib.Patr fur Gr.G.Pzgr.	1.9	Black Wooden Bullet	Large A.P. Grenade	
2. Propaganda Grenade	G.Kart.fur G. Propgr.	1.7	Red Ring	Propaganda Grenade	In the future to be used only for Rifle Propa- ganda Grenade.
3. Propaganda Grenade (Old Type)	G.Kart.(Alter Art) fur G. Propgr.	1.7	2 mm Wide Red Ring on Neck of Cart- ridge case.	Propaganda Grenade	Obsolete
4. Small A.P. Grenade	G.Kart.fur G.Pzgr.	1.1	Black ring	A.P. Grenade	Packed attached to Grenade
5. Small A.P. Grenade	G.Kart.(Alter Art) fur G. Pzgr.	1.1	Black ring (Partly)	Small A.P. Grenade	Obsolete
6. H.E. Grenade	G.Kart.fur G.Sprgr.	1.0	Yellow ring	H.E. Grenade (288 g.)	In the future to be used only for H.E. grenade
7. H.E. Grenade (Old Type)	G.Kart. (Alter Art) fur G. Sprgr.	1.0	Yellow ring (Partly)	H.E. Grenade (288 g.)	Obsolete
8. H.E. Grenade (Old Type)	G.Kart.(Alter Art) fur G. Sprgr.	0.85		H.E. Grenade (288 g.)	Packed attached to Grenade.

GERMAN

MISCELLANEOUS PISTOL GRENADES

Types

1. Smoke (Nebelpatrone fur Kampfpistole)
2. Indicator (Deutpatrone fur Kampfpistole)
3. Illuminating Star on Parachute (Fallschirm Leuchtpatrone fur Kampfpistole)

1. SMOKE (Nebelpatrone fur Kampfpistole)

Externally this is similar to the HE grenade; internally it contains a smoke generator. It is fitted with a nose fuze which is similar to that in the HE grenade, except that there is a charge of gun powder in place of the detonator below the flash cap. The projectile functions on impact. The gunpowder is ignited by the flash cap and blows off the smoke generator, at the same time igniting it. It has been ascertained that the smoke generator may be projected a considerable distance from the point of impact. The projectile may be recognized by the following stencilled marking on the base of the cartridge case: NEBEL Z.

2. INDICATOR (Deutpatrone fur Kampfpistole)

This grenade emits a puff of reddish-brown smoke after it has been in flight for about two seconds. It is similar, externally, to the two grenades described above except for the head which is parabolic. There is no fuze, the smoke train being fired by the flash from the propellant.

Weight of complete round	4½ ounces.
Weight of grenade	3 ounces..
Marking	Base of cartridge case stencilled Deut.Z.

3. ILLUMINATING STAR ON PARACHUTE (Fallschirm Leuchtpatrone fur Kampfpistole)

This grenade has the general external appearance of the other types. It has a black bakelite head which has a white spot in the center. F. Leucht.Z. is stencilled on the base of the cartridge case. The base of the projectile has a screwed-on plug which is perforated to hold a gunpowder pellet. Above this is a star to which a parachute is attached. The parachute is towards the forward end of the projectile. The action is as follows: On firing, the flash from the propellant ignites the gunpowder pellet which, after a brief delay, ignites the star. The bakelite head is blown off and the star ejected. The star is of the illuminating type.

GERMAN
RIFLE DISCHARGER
CUP TYPE
SCHIESSBECHER

The discharger is made of steel and consists of a rifled barrel which screws into a holder fitted with a clamp for attaching it to the rifle barrel. There are no gas ports, and varying ranges are obtained by altering the elevation of the rifle by the aid of the sighting attachment. With practice, however, the discharger can be used effectively without the sight.

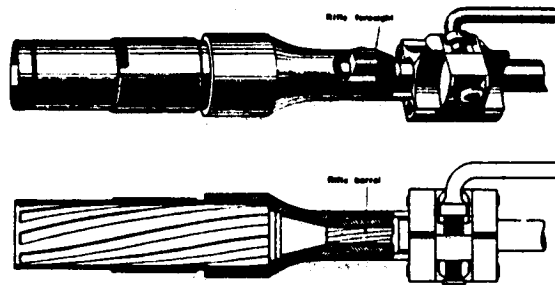

FIG. 1 RIFLE DISCHARGER (CUP TYPE)

~~SECRET~~

GERMAN

RIFLE DISCHARGER

SPIGOT TYPE

Discharger

The discharger consists of a hollow tubular spigot of about one inch diameter terminating in a part resembling the hilt of a bayonet. Over this spigot fits the hollow tail-piece of the grenade. It is fitted to the rifle, in the same manner as a bayonet, over the bayonet standard and foresight block, and is locked in position by a spring-loaded bolt. On firing the propelling cartridge, the gases pass out of the barrel of the rifle, through the spigot, and into the hollow tail piece to propel the grenade.

Sights

A swing over blade front sight is fitted to the left side of the base of the spigot.

A rear sight attachment is fitted to the left side of the rifle by means of a metal strap and thumbscrew. The body, which is movably attached to the metal strap by means of a carrier plate, is in the form of a metal box about five inches in length, on the forward end of which a V is formed. The other end, facing the firer when the sight is assembled to the rifle, is inscribed with a range scale graduated from 25 to 100 meters in steps of 25 meters. To give the desired range, the body is rotated and the appropriate graduation brought opposite a pointer on the carrier plate. The body is then held in position by a ball and spring detent.

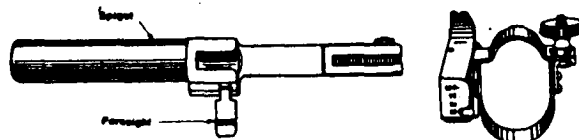

FIG. 6 RIFLE DISCHARGER (SPIGOT TYPE) AND SIGHT

GERMAN

27MM. GRENADE AND SIGNAL PISTOL KAMPFPISTOLE

Data

Overall length 9.75 inches.
Length of barrel 6.17 inches.
Total Weight 1 lb. 9½ oz.
Maximum Range 100 yards.

Description

This is the standard Walther signal pistol which has been modified by rifling the bore and by the provision of a small dial sight. With these alterations H.E. grenades and smoke grenades are fired.

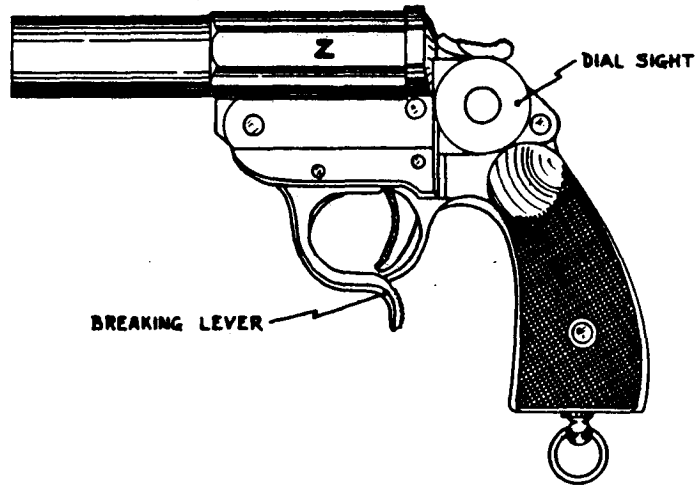



Data

Overall length 10 inches.
Length of barrel 6 inches.
Total weight 1-1/2 lbs.
Range 100 yards.

GERMAN

FLARE

PISTOL

LEUCHTPISTOLE

Description

This is the standard Walther signal pistol for which two H.E. grenades (the Wurfkorper 361 and the Wurfgranate 326) have been developed.

