

DEPARTMENT OF THE ARMY TECHNICAL MANUAL

AMMUNITION, GENERAL

This copy is a reprint which includes current pages from Changes 1 through 5.

HEADQUARTERS, DEPARTMENT OF THE ARMY

OCTOBER 1969

CHANGE)
)
No. 5)

HEADQUARTERS
DEPARTMENT OF THE ARMY
Washington, DC, 30 September 1993

AMMUNITION, GENERAL

TM 9-1300-200, 3 October 1969, is changed as follows:

1. Make the following pen-and-ink note on page 1-9, Table 1-2, Ammunition Color Coding:

"NOTE: The color coding for Smoke, WP and PWP w/explosive burster for both the 2nd Generation and the 3rd Generation are identical. The correct color coding for both these generations of WP and PWP ammunition is a yellow band with red markings, as shown in the 2nd Generation."

2. Remove old pages and insert new pages as indicated below. New or changed material is indicated by a vertical bar in the margin of the page.

Remove pages

A
i thru v (vi blank)
1-1 and 1-2
1-2.1 and 1-2.2
1-13 (1-14 blank)
2-9 and 2-10
2-19 and 2-20
3-1 and 3-2
3-17 and 3-18
4-1 and 4-2
4-5 and 4-6
4-23 and 4-24
4-29 and 4-30
6-1 and 6-2
6-3 and 6-4
6-15 (6-16 blank)
7-1 and 7-2
7-4.1 (7-4.2 blank)
7-11 and 7-12
8-1 and 8-2
8-11 and 8-12
8-15 thru 8-18
8-21 and 8-22
9-1 thru 9-4
9-7 and 9-8
9-20.1 thru 9-20.3 (9-20.4 blank)
10-1 thru 10-23 (10-24 blank)
A-1 and A-2
Index 1 and Index 2
Index 5 and Index 6

Insert pages

A and B
i thru vi
1-1 and 1-2
1-2.1 and 1-2.2
1-13 and 1-14
2-9 and 2-10
2-19 and 2-20
3-1 and 3-2
3-17 and 3-18
4-1 and 4-2
4-5 and 4-6
4-23 and 4-24
4-29 and 4-30
6-1 and 6-2
6-3 and 6-4
6-15 and 6-16
7-1 and 7-2
7-4.1 and 7-4.2
7-11 and 7-12
8-1 and 8-2
8-11 and 8-12
8-15 thru 8-18
8-21 and 8-22
9-1 thru 9-4
9-7 and 9-8
9-20.1 thru 9-20.4
10-1 and 10-2
A-1 thru A-4
Index 1 and Index 2
Index 5 and Index 6

3. File this change in front of the publication for reference purposes.

By Order of the Secretary of the Army:

GORDON R. SULLIVAN
General, United States Army
Chief of Staff

Official:

MILTON H. HAMILTON
*Administrative Assistant to the
Secretary of the Army*
04899

Distribution:

To be distributed in accordance with DA Form 12-34-E, Block 805, Requirements for TM 9-1300-200.

CHANGE)
No. 4)

HEADQUARTERS
DEPARTMENT OF THE ARMY
Washington, DC, 1 September 1989

AMMUNITION, GENERAL

TM 9-1300-200, 3 October 1969 is changed as follows:

1. Make the following pen-and-ink change:

Cross out text (using a large X) on pages as listed below and retain color illustrations as indicated.

<u>Cross out</u>	<u>Retain color illustration</u>
1-3	1-4
1-5	1-6
1-12	1-11

2. Remove old pages and insert new pages as indicated below. New or changed material is indicated by a vertical bar in the margin of the page. Added or revised illustrations are indicated by a black bar adjacent to the identification number.

<u>Remove pages</u>	<u>Insert pages</u>
A	A
iii and iv	iii and iv
iv.1 and iv.2	None
v and vi	v (vi blank)
1-1 and 1-2	1-1 and 1-2
None	1-2.1 thru 1-2.4 (blank)
None	1-13 (1-14 blank)
2-5 and 2-6	2-5 and 2-6
2-13 and 2-14	2-13 and 2-14
2-19 and 2-20	2-19 and 2-20
3-1 and 3-2	3-1 and 3-2
6-3 and 6-4	6-3 and 6-4
7-1 thru 7-4	7-1 thru 7-4
None	7-4.1 (7-4.2 blank)
7-5 and 7-6	7-5 and 7-6

3. File this change in front of the publication for reference purposes.

By Order of the Secretary of the Army:

CARL E. VUONO
General, United States Army
Chief of Staff

Official:

WILLIAM J. MEEHAN II
Brigadier General, United States Army
The Adjutant General

Distribution:

To be distributed in accordance with DA From 12-34B-R, Requirements for Ammunition, General.

CHANGE)
No. 3)

HEADQUARTERS
DEPARTMENT OF THE ARMY
Washington, DC, 4 June 1983

AMMUNITION, GENERAL

TM 9-1300-200, 3 October 1969, is changed as follows:

1. Remove old pages and insert new pages as indicated below. New or changed material is indicated by a vertical bar in the margin of the page. Added or revised illustrations are indicated by a vertical bar adjacent to the identification number.

Remove Pages
1-3 thru 1-12
2-19 and 2-20
8-17 and 8-18

Insert Pages
1-3 thru 1-12
2-19 and 2-20
8-17 and 8-18

2. File this change in front of the publication for reference purposes.

By Order of the Secretary of the Army:

E. C. MEYER
General, United States Army
Chief of Staff

Official:

ROBERT M. JOYCE
Major General, United States Army
The Adjutant General

Distribution:

To be distributed in accordance with DA Form 12-40, General Information applicable to all organizations which have a conventional munitions mission.

CHANGE }
No. 2 }

HEADQUARTERS
DEPARTMENT OF THE ARMY
WASHINGTON, DC 4 March 1977

AMMUNITION, GENERAL

TM 9-1300-200, 3 October 1969, is changed as follows:

1. Remove old pages and insert new pages as indicated below. New or changed material is indicated by a vertical bar in the margin of the page. Added or revised illustrations are indicated by a vertical bar adjacent to the identification number.

i and ii	i and ii
v	v/(vi Blank)
1-1 and 1-2	1-1 and 1-2
4-1 and 4-2	4-1 and 4-2
4-7 and 4-8	4-7 and 4-8
None	4-8.1 through 4-8.
11-1 through 11-9	11-1 through 11-
A-1 and A-2	A-1 and A-2
Index 1 and Index 2	Index 1 and Index 2
Index 7 and Index 8	Index 7 and Index 8

2. File this change in front of the publication for reference purposes.

By Order of the Secretary of the Army:

Official:

PAUL T. SMITH
Major General, United States Army
The Adjutant General

BERNARD W. ROGERS
General, United States Army
Chief of Staff

Distribution:

To be distributed in accordance with DA Form 12-40, General Information Applicable to all Organizations which have a conventional munitions missions.

LIST OF EFFECTIVE PAGES

INSERT LATEST CHANGED PAGES.
DESTROY SUPERSEDED PAGES.

NOTE

The portion of the text affected by the changes is indicated by a vertical line in the outer margins of the page. Changes to illustrations are indicated by a vertical line adjacent to the identification number.

**TOTAL NUMBER OF PAGES IN THIS PUBLICATION IS 242
CONSISTING OF THE FOLLOWING:**

<i>Page No.</i>	<i>* Change No.</i>	<i>Page No.</i>	<i>*Change No.</i>
Cover	0	2-24 blank	0
A and B	5	3-1 and 3-2	5
i	5	3-3 thru 3-16	0
ii	2	3-17 and 3-18	5
iii	4	3-19	0
iv thru vi	5	3-20 blank	0
1-1	5	4-1 and 4-2	5
1-2	4	4-3 thru 4-4	0
1-2.1	5	4-5 and 4-6	5
1-2.2 and 1-2.3	4	4-7	0
1-2.4 blank	4	4-8	2
1-3 blank	4	4-8.1 thru 4-8.4	2
1-4	0	4-9 thru 4-22	0
1-5 blank	4	4-23 and 4-24	5
1-6 thru 1-10	3	4-25 and 4-26	0
1-11	1	4-27 and 4-28	1
1-12 blank	4	4-29 and 4-30	5
1-13 and 1-14	5	4-31 and 4-32	1
2-1 thru 2-4	0	5-1 thru 5-16	1
2-5	4	6-1 thru 6-4	5
2-6 thru 2-9	0	6-5 thru 6-14	0
2-10	5	6-15 and 6-16	5
2-11 and 2-12	0	7-1 and 7-2	5
2-13	4	7-3	0
2-14 thru 2-18	0	7-4	4
2-19	5	7-4.1 and 7-4.2	5
2-20	4	7-5	4
2-21 thru 2-23	0	7-6 thru 7-10	0

* Zero indicates an original page.

LIST OF EFFECTIVE PAGES cont.

<i>Page No.</i>	<i>* Change No.</i>	<i>Page No.</i>	<i>*Change No.</i>
7-11 and 7-12	5	9-17 thru 9-20	1
7-13	0	9-20.1 thru 9-20.4	5
7-14 blank	0	10-1 and 10-2	5
8-1 and 8-2	5	10-3 thru 10-24 blank	Deleted
8-3 thru 8-10	0	11-1 thru 11-8	2
8-11 and 8-12	5	12-1 thru 12-6	0
8-13 and 8-14	0	13-1 thru 13-7	0
8-15 thru 8-18	5	13-8 blank	0
8-19 and 8-20	0	A-1 thru A-4	5
8-21 and 8-22	5	Index 1 and 2	5
8-23 thru 8-25	0	Index 3 and 4	0
8-26 blank	0	Index 5	1
9-1 thru 9-4	5	Index 6	5
9-5 and 9-6	0	Index 7 and 8	2
9-7 and 9-8	5	Authentication page	0
9-9 thru 9-16	0		

* Zero indicates an original page.

Change 5 B

AMMUNITION, GENERAL

	Paragraph	Page
CHAPTER 1. GENERAL		
Section I. Introduction	1-1	1-1
II. General discussion	1-3	1-1
CHAPTER 2. EXPLOSIVE AND CHEMICAL AGENTS		
Section I. Solid propellants	2-1	2-1
II. Liquid propellants	2-7	2-5
III. Low explosives	2-11	2-6
IV. High explosives	2-15	2-11
V. Chemical agents	2-19	2-19
CHAPTER 3. SMALL ARMS AMMUNITION	3-1	3-1
4. ARTILLERY AMMUNITION		
Section I. General	4-1	4-1
II. Complete rounds	4-5	4-3
III. Fuzes	4-12	4-18
IV. Practice, dummy, blank and subcaliber ammunition	4-15	4-26
V. Precautions	4-19	4-29
VI. Packing and marking	4-21	4-30
CHAPTER 5. ROCKETS		
Section I. Introduction	5-1	5-1
II. Complete round	5-5	5-3
III. Warhead	5-7	5-3
IV. Motor	5-13	5-4
V. Launchers	5-15	5-6
VI. Fuzes	5-17	5-6
VII. Identification and packing	5-19	5-7
VIII. Shoulder-fired rockets	5-29	5-11
IX. Ground-to-ground rockets	5-23	5-13
X. Aircraft rockets	5-25	5-12
XI. Precautions in storage and handling	5-21	5-13
XII. Firing precautions	5-27	5-14
CHAPTER 6. GRENADES		
Section I. Introduction	6-1	6-1
II. Hand grenades	6-3	6-3
III. Rifle grenades	6-4	6-6
IV. Identification and packing	6-6	6-12
V. Precautions in storage and handling	6-7	6-15
VI. Precautions in firing	6-9	6-15
CHAPTER 7. LAND MINES	7-1	7-1
8. DEMOLITION MATERIALS	8-1	8-1
9. PYROTECHNICS	9-1	9-1
10. BOMBS	DELETED	
CHAPTER 11. SCATTERABLE MINES		
Section I. Introduction	11-1	11-1
II. Mine dispersing subsystem, aircraft: M56	11-3	11-1

*This manual supersedes TM 9-1900/TO 11A-1-20, June 1956 including all changes.

	Paragraph	Page
CHAPTER 12. GUIDED MISSILES	12-1	12-1
13. PROPELLANT ACTUATED DEVICES.....	13-1	13-1
APPENDIX.....		A-1
INDEX.....		Index 1

LIST OF ILLUSTRATIONS

Figure No.	Title	Page
1-1	Color identification of typical pyrotechnic items	1-4
1-2	Deleted	
1-3	Color identification and typical marking of packing boxes and fiber containers	1-11
2-1	Shapes and forms of propellant grains	2-2
2-2	Relative sizes of propellant grains	2-2
2-3	Burning of propellant grains.....	2-3
2-4	Progressive burning of propellant grains (multiperforated)	2-3
2-5	Ball powder X25	2-4
2-6	Explosive trains-artillery ammunition	2-7
2-7	Detonating wave amplified by use of a booster	2-12
2-8	Schematic arrangements of explosive train components	2-14
3-1	Typical cartridge (sectioned)	3-1
3-2	7.62-mm bullets (sectioned)	3-2
3-3	5.56-mm and caliber .50 spotter-tracer bullets (sectioned)	3-3
3-4	Caliber .30 bullets (sectioned)	3-4
3-5	7.62-mm cartridges	3-5
3-6	5.56-mm cartridges	3-6
3-7	Caliber .30 cartridges	3-7
3-8	Caliber .30 carbine and caliber .45 cartridges	3-8
3-9	Caliber .50 cartridges	3-9
3-10	20-mm cartridges	3-10
3-11	Typical 30-mm cartridges	3-11
3-12	Caliber .22 cartridges	3-12
3-13	Caliber .38 cartridges	3-13
3-14	12-gage shotgun shells	3-14
3-15	Linked 7.62-mm cartridges	3-14
3-16	Links for caliber .30 and caliber .50 ammunition	3-15
3-17	Bandoleer, magazines, filler and clips	3-16
3-18	Cartridges in 20-round cartons in ammunition box	3-17
3-19	Cartridges, link belt, cartons, bandoleers and ammunition box	3-18
3-20	Ammunition boxes in wire bound box	3-18
4-1	Types of complete rounds	4-2
4-2	High-explosive projectile	4-4
4-3	High-explosive rocket-assisted projectile	4-5
4-4	High-explosive antitank projectile.....	4-6
4-5	Burster chemical projectile	4-7
4-6	BE chemical (smoke) projectiles	4-8
4-6.1	155-mm projectile, HE, M483A1	4-8.1
4-6.2	Warhead M251	4-8.2
4-6.3	Typical CBU	4-8.2
4-6.4	Dual purpose munition	4-8.3
4-7	Illuminating projectiles	4-9
4-8	Armor-piercing projectile	4-10
4-9	Armor-piercing capped cartridge	4-11
4-10	Antipersonnel (APERS) cartridge	4-12
4-11	Canister cartridge	4-13
4-12	Flash reducer	4-13
4-13	Propellant temperature indicator with thermometer	4-14
4-14	Percussion primer	4-15
4-15	Combination electric and percussion primer	4-16
4-16	Burster charge	4-16
4-17	Booster charge.....	4-17
4-18	Base-detonating fuze	4-19
4-19	Point-initiating, base-detonating fuze	4-20
4-20	Point-detonating fuze	4-21
4-21	Impact fuze	4-22

Figure No.	Title	Page
4-22	Time fuse, powder train	4-23
4-23	Time fuse, gear trains	4-24
4-24	Proximity fuses	4-25
4-25	Concrete-piercing fuse	4-26
4-26	Recoilless rifle, target practice cartridge	4-26
4-27	Mortar target practice cartridge	4-27
4-28	(Deleted)	
4-29	(Deleted)	
4-30	(Deleted)	
4-31	(Deleted)	
4-32	(Deleted)	
4-33	(Deleted)	
4-34	Dummy projectile	4-28
4-35	Blank cartridge	4-28
4-36	(Deleted)	
4-37	Typical wooden packing box	4-31
5-1	Principles of rocket propulsion.....	5-2
5-2	Major components of rocket motor	5-4
5-3	Packaging of small, complete round rocket	5-7
5-4	Typical rocket motor container for large motor	5-8
5-5	Typical warhead container for large warhead.....	5-8
5-6	Hermetically sealed container for proximity fuze	5-9
5-7	Metal container for proximity fuze	5-9
5-8	Wooden packing box for proximity fuzes.....	5-9
5-9	Exterior and cross section of 66-mm LAW rocket.....	5-10
5-10	6mm LAW system.....	5-10
5-11	Typical 1.6-Inch rocket	5-11
5-12	Long range, ground-to-ground rocket.....	5-12
5-13	Typical 2.75-inch aircraft rocket	5-13
6-1	Representative grenades	6-2
6-2	Hand grenade types	6-4
6-3	Illuminating hand grenade	6-5
6-4	Hand grenade simulator	6-5
6-5	Grenade launcher	6-6
6-6	Grenade cartridge	6-7
6-7	Projection adapter	6-8
6-8	HEAT rifle grenade	6-9
6-9	Burning-type (colored smoke) rifle grenade	6-10
6-10	Bursting-type (WP smoke) rifle grenade.....	6-11
6-11	Typical fiber container for rifle grenade	6-12
6-12	Typical packing boxes for grenades	6-14
7-1	Representative types of land mines.....	7-2
7-2	APERS mine ready for firing-A, by observer; B, by enemy	7-3
7-3	Typical bounding-type practice APERS mine	7-4
7-3.1	Typical Nonmetallic practice APEAS mine, M17	7-4.1
7-4	Nonmetallic APERS mine	7-5
7-5	Heavy AT mine	7-5
7-6	Heavy AT mine with fuse installed (cross section)	7-6
7-7	AT mine activator.....	7-6
7-8	Nonmetallic AT mine and fuse	7-7
7-9	Light AT mine and fuse	7-8
7-10	Off-route AT mine	7-8
7-11	Practice heavy AT mine	7-9
7-12	Insert light AT mine and Inert fuze.....	7-9
7-13	Installation of a boobytrapped AT mine	7-9
7-14	Incendiary burster	7-10
7-15	Representative methods of using firing devices in boobytrap installation.....	7-11
7-16	Packing box for APERS mine.....	7-12
7-17	Packing box for APERS practice mine and replacement parts.....	7-12
7-18	Heave AT mine as shipped	7-12
7-19	Metal packing box for 8 AT mines and 8 AT mine fuzes or 12 light AT practice mine without fuzes.....	7-12
8-1	Tetryol demolition block	8-2
8-2	Plastic demolition charges.....	8-3
8-3	Composition C4 block charge.....	8-3

Figure

<i>No.</i>	<i>Title</i>	<i>Page</i>
8-4	Cratering-type block demolition charge	8-4
8-5	15-Pound shaped demolition charge	8-5
8-6	40-Pound shaped demolition charge	8-5
8-7	8-Second delay friction detonator	8-7
8-8	8-Second delay friction detonator	8-7
8-8	15-Second delay friction detonator	8-7
8-9	8-Second delay percussion detonator	8-8
8-10	15-Second delay percussion detonator	8-9
8-11	Universal explosive destructor	8-9
8-12	Explosive destructor	8-10
8-13	Friction tinge blasting fuse igniter	8-11
8-14	Weatherproof time-blasting fuse igniter	8-11
8-15	Time blasting fuse (safety fuse)	8-12
8-16	Time blasting fuse	8-12
8-17	Typical detonating cord	8-13
8-18	Delay-type demolition firing device	8-13
8-19	Pressure-type demolition firing device	8-14
8-20	Pull-release type demolition firing device	8-14
8-21	Pull-type demolition firing device	8-15
8-22	Pressure-release type demolition firing device	8-15
8-23	Release-type demolition firing device	8-16
8-24	Percussion primer	8-16
8-25	Blasting caps	8-16
8-26	Use of explosive priming adapter	8-17
8-27	Bangalore torpedo demolition kit	8-19
8-28	Earth rod explosive kit	8-20
8-29	Demolition charge assembly	8-21
8-30	Demolition priming assembly	8-21
8-31	Projected charge demolition kit-arrangements of components in case	8-22
8-32	Projected charge demolition kit-laying cable over antipersonnel mine fields	8-23
8-33	Typical projected charge (rigid type) being pushed by a medium tank	8-24
8-34	Linear projected charge	8-25
8-35	Linear projected charge (cover removed)	8-25
9-1	Types and comparative sizes of military pyrotechnics	9-2
9-2	Representative ignition train	9-4
9-3	Aircraft parachute (illuminating) flare	9-5
9-4	Aircraft parachute flare with shade	9-6
9-5	Airport flare	9-8
9-6	Surface trip flare	9-9
9-7	Guide flare	9-10
9-8	Ramjet engine igniter	9-11
9-9	Aircraft signal patterns	9-12
9-10	Handheld marine smoke signal	9-13
9-11	High drift signal	9-14
9-12	Aircraft float light	9-15
9-13	Grenade-launcher ground signal	9-16
9-14	Rocket-propelled ground signal	9-17
9-15	Air burst simulator	9-18
9-16	Boobytrap simulator	9-18
9-17	Ground burst simulator	9-19
9-18	Artillery flash simulator	9-20
9-19	Hand grenade simulator	9-20.1
9-20	Explosive simulator	9-20.1
9-21	Packing box for ground signals	9-20.2
9-22	Packing box for aircraft signals	9-20.2
10-1 thru 10-26	Deleted

Figure
No.

Title

Page

11-1	Sequence of mine functioning	11-1
11-2	Mine dispersing subsystem, aircraft: M56	11-2
11-3	Canister assembly	11-2
11-4	Mine dispersing subsystem, aircraft: M56 mounted on UH-1H helicopter (the struts, pylon assembly, pylon support, and support assembly comprise the multi-armament kit)	11-3
11-5	Shipping and storage container CNU-79/E	11-4
11-6	Mine canister shipping and storage container M602 (as used in reload kit)	11-5
11-7	Mine dispersing subsystem, M56 dispenser (DISP) control panel	11-7
12-1	Typical guided missile showing location of components	12-1
12-2	High explosive fragmentation warhead.....	12-4
12-3	Safety and arming device	12-5
13-1	Explosive embedment anchor	13-2
13-2	Mechanically fired cutter	13-3
13-3	Electrically fired cutter	13-4
13-4	Parachute ejector	13-4
13-5	Stores ejector cartridge	13-5
13-6	Fire extinguisher cartridges	13-6
13-7	Cable cutter cartridges	13-6
13-8	Escape system cartridge set	13-7
13-9	Training catapult cartridge.....	13-7
13-10	Parachute release delay cartridge	13-7

Change 5 v

THIS PAGE INTENTIONALLY LEFT BLANK

Change 5 vi

CHAPTER 1

GENERAL

Section I. INTRODUCTION

1-1. Scope

This manual contains basic information on identification, classification, and physical characteristics of conventional ammunition. With TM 90 1300-206, it constitutes a source book on military ammunition.

1-2. Forms and Reports

a. Authorized Forms. DA Pam 738-750 contains instructions on use of the forms required to report incidents involving the ammunition covered in this manual. AR's 380-5, 380-6, and 380-40 cover classification of records and reports.

b. Accidents. Responsibilities and procedures for recording and reporting accidents involving injury to personnel or damage to equipment or property are contained in AR 385-40. Use of DA Form 285 is required.

c. Fire Reports. As prescribed by AR 420-90, DA Form 2324 and 2324-1 will be used to report technical information and actions relating to fires or explosions followed by fire, incident to an Army operation or activity in other than officially designated combat zones. DA Forms 2324 and 2324-1 are required in addition to the accident reports prescribed by AR 385-40.

d. Malfunction. Malfunction of Class V ammunition (e.g., bulk explosives, demolition materials, cartridges, propelling charges and projectiles) will be reported immediately by the commanding officer (or senior individual) in charge of the unit. Reports will be directed to the ammunition officer under whose supervision the ammunition is maintained or issued. The ammunition officer, after thorough investigation, will report other

than routine cases in accordance with AR 75-1. Malfunctions involving auxiliary gear or nonexplosive components, not involving contributory safety hazards (e.g., premature arming), will be reported in accordance with TB 9-1100-803-15.

e. Report of Safety Problems Involving Military Explosives or Ammunition. The Armed Services Explosives Safety Board must be kept informed of safety problems relating to development, manufacture, testing, handling, transportation, storage, maintenance, salvage and disposal of ammunition and explosives. Commanders of major commands will forward reports of such problems to the Board through the Deputy Chief of Staff for Personnel, ATTN: Director of Safety, Department of the Army, Washington, DC 20310. General schematic plans, siting plans, and specifications for construction of new facilities or major modifications to existing facilities for manufacturing, handling, transporting, storing, or testing military explosives or ammunition will be referred to the Board for review, through the Deputy Chief of Staff for Logistics and the Deputy Chief of Staff for Personnel. See AR 385-60 for further information.

f. Errors, Omissions and Recommended Changes. Reporting of errors, omissions, and recommendations for improving this publication by the individual user is encouraged. Reports should be submitted on DA Form 2028 (Recommended

Changes to Publications) and forwarded direct to: Commander, ARDEC, ATTN: SMCAR-LMB, Picatinny Arsenal, NJ 07806-5000.

Section II. GENERAL DISCUSSION

1-3. Classification

a. Ammunition is classified according to its physical characteristics. The basic types-artillery ammunition, grenades, rockets, etc.-are defined in this paragraph, in JCS Pub 1, or in AR310-25 Further classification within these basic types is

based on the following:

(1) Standardization (standard, substitute standard, or limited standard).

(2) Use (service, practice, dummy, or blank).

(3) Form (fixed, semifixed, separated, or separate loading).

(4) Kind of filler (explosive, chemical, leaflet, or inert).

b. For purposes of handling and storage, ammunition is identified by the following:

(1) Quantity-distance class.

(2) Storage compatibility group.

(3) Burning or explosive characteristics.

These categories are discussed in detail in TM 9-1300-206.

c. Further classification for handling and shipping is based on the following:

(1) Department of Transportation Shipping Regulations (see AR's 55-228 and 55-355 and Bureau of Explosives Tariff BOE 6000).

(2) Security regulations (see AR 380-5).

1-4. Identification

Army adopted items of materiel which have been type classified in accordance with AR 700-20, and component items designated reportable in accordance with Circular 310-70 are officially identified by logistical terms to facilitate supply in the field. Thus, the standard nomenclature, code symbols, etc., must be used in messages, requisitions, and records.

a. *Standard Nomenclature.* Standard nomenclature for the ammunition covered in this manual consists of an item name and a model designation. Sufficient additional information differentiates between items having the same item name. *For example:* CARTRIDGE, 152 MILLIMETER: HE, M657E2w/fuze, PD, M720E1.

b. *Federal Item Identification.* A National Item Identification Number (NIIN) is an approved item identification for an item of supply to which a Federal Stock Number (FSC) is assigned. It consists of the data adequate to establish the essential characteristics of the item which make it unique and differentiate it from other item of supply.

c. *Department of Defense Ammunition Code (DODAC).* An eight-character number divided into two parts separated by a hyphen. The first part consists of four numerals; e.g., 1320, which forms the Federal Supply Classification (FSC) code number assigned to the items covered by the ammunition generic description (see SB 700-20). The second part consists of a letter and three numerals assigned to an ammunition generic description with the FSC class; e.g.,

D548, assigned to Projectile, 155 Millimeter, Smoke, HC.

d. *NSNs and DODAC's.* The National/NATO Stock Number, e.g., NSN 1325-00-028-5298, has replaced the Federal Stock Number (FSN). There is a different NSN for each item of supply. The first four digits in an NSN are always the FSC class to which the item belongs. The next seven digits constitute the NIIN. The dash between the third and fourth digits in the NIIN serves to reduce errors in transmitting. There is a different NIIN for each item. A Department of Defense identification code (DODIC) is added as a suffix to the NSN, e.g., 1325-00o-28-5298E450. The DODAC is an eight-character representation consisting of the four-character FSC code number and a second part consisting of a letter and three digits (DODIC). Thus, for example, 1325-E450, a typical DODAC, consists of FSC class 1325 and DODIC E450. The DODIC, when suffixed to more than one NSN, indicates items are interchangeable for issue and use.

e. *Mode.* To identify a particular design, a model designation is assigned at the time the model is classified as an adopted type. This model designation, an essential part of the nomenclature, is included in the marking of the item. A model designation consists of an M followed by an Arabic numeral M1 is an example. Modifications are indicated by adding an A and the appropriate Arabic numeral. Thus M1A1 indicates the first modification of an item for which the original model designation was M1. An XM designation signifies that the item is under development. An E designates an experimental or noncertified change to an item (e.g., Propellant M26E1 indicates an experimental change to Propellant M26).

f. *Lot Number.*

(1) When ammunition is manufactured, an ammunition lot number is assigned in accord with pertinent specifications. As an essential part of the marking, this lot number is stamped or marked on the item, size permitting, as well as on all packing containers. It is required for all purposes of record, including reports on condition and functioning, and for accidents in which the ammunition is involved.

(2) To provide for the most uniform functioning, all of the components in any one lot are manufactured under as nearly identical, conditions as practicable. To obtain the greatest accuracy when firing fixed or semifixed ammunition, successive rounds should be of the same lot number; when firing separate-loading ammunition, successive rounds should consist of projectiles of one lot.

number, propelling charges of one lot number, fuzes of one lot number and primers of one lot number.

(3) An X appearing after the lot number of a cartridge case indicates a steel case. Lots reworked or renovated once have an A after the lot number; twice, a B, etc.

(4) The ammunition data card (DD 1650), a basic reference document, is a 5-by 8-inch card prepared for each lot of accepted ammunition. DD 1650 is furnished with the shipping ticket with each shipment of ammunition, except small arms ammunition. Information on the data card includes lot number, date packed, identity of components, expected pressures and Instructions. National/NATO Stock Numbers, etc.

g. Calibration of Lots. Calibration data for certain lot of artillery ammunition are computed to improve the relative accuracy of predicted fire. The data account for variations in performance due to the employment of individual ammunition-weapon combinations. TC 6-40 contains detailed information on methods of calibration and the application of calibration data.

1-5. Marking

a. The marking stenciled or stamped on ammunition includes all the information necessary for complete identification. In addition to standard nomenclature and lot numbers, marking may include such information as the model and type of fuze, and the weapon in which the item is fired. In the case of separate-loading artillery ammunition, marking includes the weight of the projectile. Except on small arms cartridges, marking does not include grade. In the case of some rounds of small caliber artillery ammunition, the muzzle velocity may appear on the packing box; otherwise, this information can be obtained from firing tables and ammunition data cards.

b. Service components or rounds that have been inserted for training purposes are marked as follows:

(1) Components such as cartridges, projectiles, fuzes, boosters, artillery primers, cartridge cases, bombs, and flares in which all explosives, incendiary, or toxic materials have been simulated by substitution of inert material are identified by Impressed INERT markings.

(2) Such components as cartridges, projectiles, fuzes, boosters, artillery primers, cartridge cases, bombs, and flares in which all explosives,

incendiaries and toxics have been omitted are identified by stamped EMPTY markings.

(3) Such components as empty projectiles, bombs, inert-loaded and empty cartridge cases, in addition to being marked INERT or EMPTY, have four holes, not smaller than one-quarter of an inch, drilled 90° apart, if size permits. Exceptions are Inert projectiles, such as those used in target practice, practice bombs, and other Inert items, the designed use of which would be Impaired by the presence of drilled holes. Such items are considered suitably identified when they are INERT marked.

(4) Inert, cloth-covered components, such as bagged propelling charges, are marked with durable, waterproof, sunfast ink.

(5) Inert mortar propellant increments have INERT cut through each increment.

1-6. Painting

Ammunition is painted to prevent rust and to provide, by the color, a means of identification or camouflage. A color coding system is employed to indicate the primary use of items of ammunition, the presence of a hazardous (explosive, flammable, irritant or toxic) filler and/or the color of tracers, dye loads and flash signals. Table 1-1 lists the generally used color schemes for ammunition.

a. Primary Use. The color indicating primary use is applied, preferable, to the entire exterior surface as the background color of the item. However, if either tactical or technical considerations indicate a different background color, primary use may be indicated by the color of the markings and/or a band of color not more than 2 inches wide. Discs, squares, or triangles of the appropriate color can also be used to indicate the primary use of the item. The most prevalent use of this exception to the rule is found in the fact that a vast majority of HIGH EXPLOSIVE loaded ammunition is simply painted olive drab and marked in yellow.

b. Hazardous Filler. Items with hazardous fillers (not indicated by the primary, use code) employ bands of color, data markings, etc., to indicate the nature of the hazard. For example, the background color of a WP smoke round may be a light green to indicate its primary use. Markings in red will indicate incendiary characteristics, and a yellow band will indicate the presence of an explosive burster.

c. Tracers. The presence of a tracer (if the color is significant) is indicated by a series of T's in the same color as the tracer; dye loads, by D's in the color of the dye; and flash signals (color bursts) by C's in the appropriate color.

d. Color Coding. Ammunition color coding is now in its third generation. Since ammunition has a long shelf life, some very old items may occasionally be encountered. The three generations of color coding are illustrated in Table 1-2. Ammunition manufactured prior to 1962 was generally painted as shown for the first generation color code. The second generation coding was used between 1962 and approximately 1976 when the third generation code came into use.

e. Application of Color Coding. The color code in Table 1-2, applies to all ammunition items in this manual, except the following:

- (1) Small arms ammunition (see Chapter 3).

- (2) Blank ammunition.
- Figure 1-2. Deleted.
- (3) Cartridge cases.
- (4) Propelling charges.
- (5) Fuzes.
- (6) Propellant-actuated devices.
- (7) Pyrotechnic devices. (Color to be used in pyrotechnic item to indicate the pyrotechnic effect. The tops of ground signals (fig. 1-1), for example, are painted in the color of the signal and embossed for ease in identification).
- (8) Demolition accessories and ammunition components which do not require color coding for identification purposes.

Table 1-1. Generally Used Color Schemes for Ammunition (see Table 1-2)

<u>Type of Ammunition</u>	<u>Body</u>	<u>Markings</u>	<u>Band</u>
High Explosive,(HE), except 20MM	Olive Drab	Yellow	None
High Explosive, (HE), 20m	Yellow	Black	None
Explosive Binary Munitions	Olive Drab	Yellow	Broken Yellow
High Explosive Plastic (HEP)	Olive Drab	Yellow	Black
High Explosive Anti- tank (HEAT)	Black	Yellow	None
Antipersonnel and anti-tank mines	Olive Drab	Yellow	Yellow Triangles
Incendiary	Light Red	Black	None
High Explosive Incendiary (HEI)	Yellow	Black	Light Red
Armor Piercing Incendiary (API)	Black	White	Light Red
Armor Piercing (AP) (a) with bursting charge	Black	Yellow	None
(b) without bursting charge	Black	White	None
Canister	Olive Drab	White	None
Flechette loaded	Olive Drab	White	None

Table 1-1. Generally Used Color Schemes for Ammunition (see Table 1-2) (continued)

<u>Type of Ammunition</u>	<u>Body</u>	<u>Markings</u>	<u>Band</u>
Illuminating			
(a) separate loading	Olive Drab	White	White
(b) fixed or semi-fixed	White	Black	None
Practice			
(a) with low explosives to indicate functioning	Blue	White	Brown
(b) with high explosive to indicate functioning	Blue	White	Yellow
(c) Without explosive to indicate functioning	Blue	White	None
Screening or Marking			
Smoke Ammunition			
(a) Filled with other than white phosphorus	Light Green	Black	None
(b) Filled with white phosphorus	Light Green	Light Red	Yellow
Inert (training) ammunition not designed to be delivered in a delivery system	Bronze, Gold, Brass	Black	None
Chemical			
(a) Filled with a riot control agent	Gray	Red	Red
(b) Filled with an incapacitating agent	Gray	Violet	Violet
(c) Filled with a toxic chemical agent other than binary agents	Gray	Dark Green	Dark Green
(d) Filled with a toxic chemical binary nerve agent	Gray	Dark Green	Broken Dark Green

number, propelling charges of one lot number, fuzes of one lot number and primers of one lot number.

(3) An X appearing after the lot number of a cartridge case indicates a steel case. Lots reworked or renovated once have an A after the lot number; twice, a B, etc.

(4) The ammunition data card (DD 1650), a basic reference document, is a 5-by 8-inch card prepared for each lot of accepted ammunition. DD 1650 is furnished with the shipping ticket with each shipment of ammunition, except small arms ammunition. Information on the data card includes lot number, date packed, identity of components, expected pressures and instructions, Federal Stock Numbers, etc.

g. Calibration of Lots. Calibration data for certain lots of artillery ammunition are computed to improve the relative accuracy of predicted fire. The data account for variations in performance due to the employment of individual ammunition-weapon combinations. FM 640 contains detailed information on methods of calibration and the application of calibration data.

1-5. Marking

a. The marking stenciled or stamped on ammunition includes all the information necessary for complete identification. In addition to standard nomenclature and lot numbers, marking may include such information as the model and type of fuze, and the weapon in which the item is fired. In the case of separate-loading artillery ammunition, marking includes the weight of the projectile. Except on small arms cartridges, marking does not include grade. In the case of some rounds of small caliber artillery ammunition, the muzzle velocity may appear on the packing box; otherwise, this information can be obtained from firing tables and ammunition data cards.

b. Service components or rounds that have been inerted for training purposes are marked as follows:

(1) Components such as cartridges, projectiles, fuzes, boosters, artillery primers, cartridge cases, bombs, and flares in which all explosives, incendiary, or toxic materials have been simulated by substitution of inert material are identified by impressed INERT markings.

(2) Such components as cartridges, projectiles, fuzes, boosters, artillery primers, cartridge cases, bombs, and flares in which all explosives, incendiaries and toxics have been omitted are identified by stamped EMPTY markings.

(3) Such components as empty projectiles, bombs, inert-loaded and empty cartridge cases, in addition to being marked INERT or EMPTY, have four

holes, not smaller than one-quarter of an inch, drilled 90° apart, if size permits. Exceptions are inert projectiles, such as those used in target practice, practice bombs, and other inert items, the designed use of which would be impaired by the presence of drilled holes. Such items are considered suitably identified when they are INERT marked.

(4) Inert, cloth-covered components, such as bagged propelling charges, are marked with durable, waterproof, sunfast ink.

(5) Inert mortar propellant increments have INERT cut through each increment.

1-6. Painting

Ammunition is painted to prevent rust and to provide, by the color, a means of identification or camouflage. A color coding system is employed to indicate the primary use of items of ammunition, the presence of a hazardous (explosive, flammable, irritant or toxic) filler, and/or the color of tracers, dye loads and flash signals.

a. Primary Use. The color indicating primary use is applied, preferably, to the entire exterior surface as the background color of the item. However, if either tactical or technical considerations indicate a different background color (e.g., olive drab for certain explosive items), primary use may be indicated by a band of color not more than 2 inches wide. If neither background color nor bands are feasible, primary use may be indicated by disks or squares in the appropriate color. Data markings (nomenclature, lot numbers, etc.), usually in black or white, may also be color coded. This applies if the primary color cannot be applied elsewhere, or if a need for more than one color code is indicated.

Table 1-1. Primary Use Code

Color	Primary use
Yellow	High explosive
Brown	Low explosive
Cray	Chemical
Light green	Smoke
Light red	Incendiary
White	Illuminating/pyrotechnic
Black	Armor defeating
Aluminum/silver	Countermeasure
Light blue	Noncombat (practice)
Bronze	Noncombat (training)

b. Hazardous Filler. Items with hazardous fillers (not indicated by the primary use code)

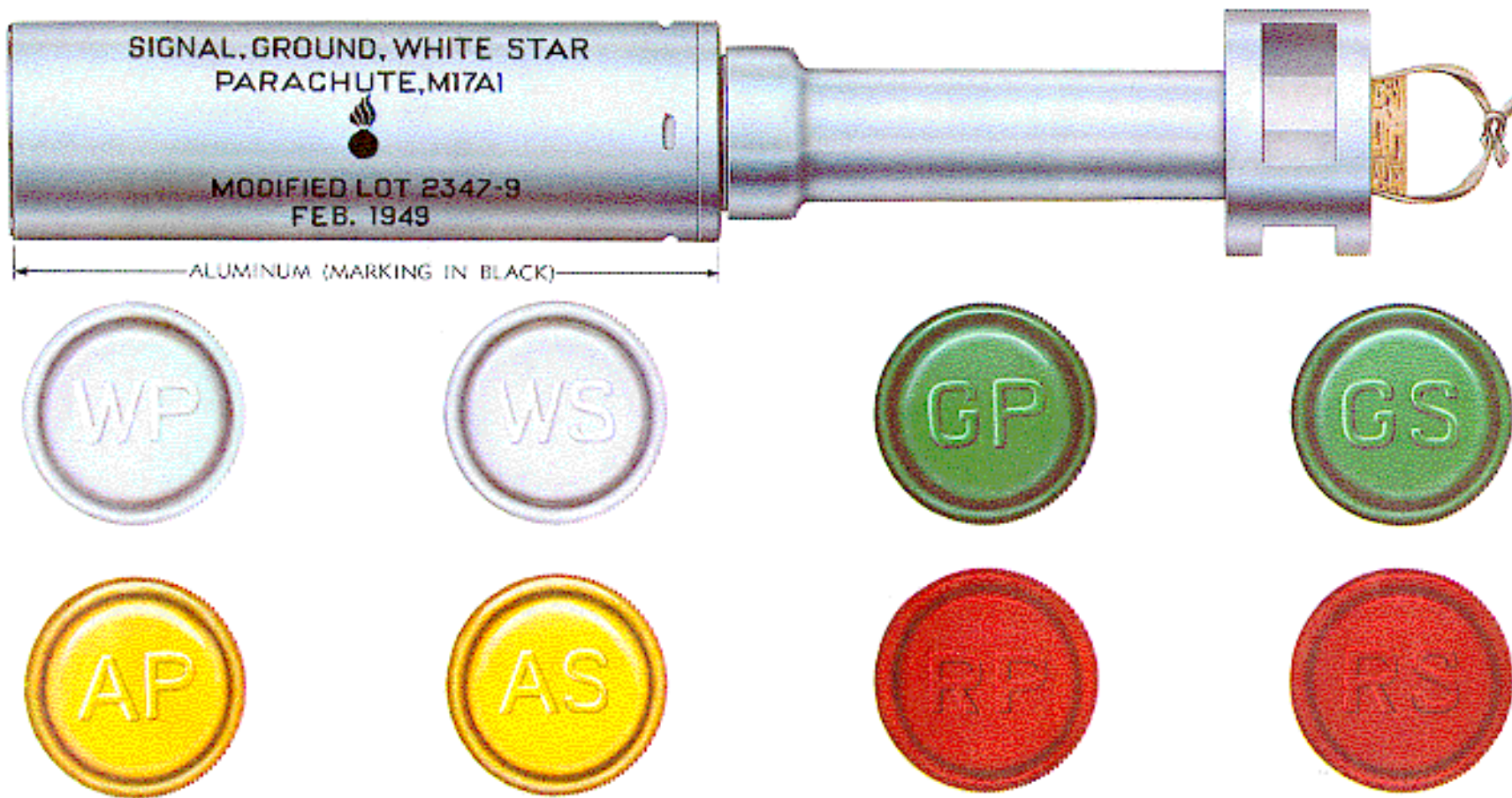

Figure 1-1. Color identification of typical pyrotechnic items.

RA PD 167581

employ bands of color, data markings, etc., to indicate the nature of the hazard. For example, the background color of a WP smoke round may be a light green to indicate its primary use. Markings in red will indicate incendiary characteristics, and a yellow band will indicate the presence of an explosive burster.

c. Tracers. The presence of a tracer (if the color is significant) is indicated by a series of T's in the same color as the tracer; dye loads, by D's in the color of the dye; and flash signals (color bursts) by C's in the appropriate color.

d. Color Coding. Ammunition color coding is now in its third generation. Since ammunition has a long shelf life, some very old items may occasionally be encountered. The three generations of color coding are illustrated in table 1-2. Ammunition manufactured prior to 1962 was generally painted as shown for the first generation color code. The second generation coding was used between 1962 and approximately 1976 when the third generation code came into use. *e. Application of Color Coding.* The color code in table 1-2 applies to

all ammunition items in this manual, except the following:

- (1) Small arms ammunition (see ch 3).
- (2) Blank ammunition.

Figure 1-2. Deleted.

- (3) Cartridge cases.
- (4) Propelling charges.
- (5) Fuzes.
- (6) Propellant-actuated devices.
- (7) Pyrotechnic devices. (Color is used in pyrotechnic items to indicate the pyrotechnic effect. The tops of ground signals (fig. 1-1), for example, are painted in the color of the signal and embossed for ease in identification.)
- (8) Demolition accessories and ammunition components which do not require color coding for identification purposes.

Table 1-2. Ammunition Color Coding

HIGH EXPLOSIVE				ARMOR DEFEATING			ANTIPER- SONNEL	MINES
HE (BINARY)	HE (20 mm only)	HE	HEI	AP W/ EXPLOSIVE FILLER APC AND HEAT	AP-APDS-AP: W/O EXPLOSIVE FILLER	HEP	W-FLECHETTES	(AP or AT)
3rd Generation								
2nd Generation								
1st Generation								











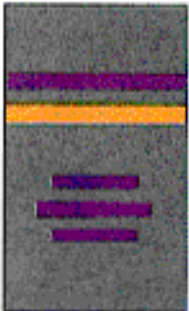
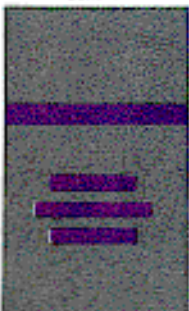
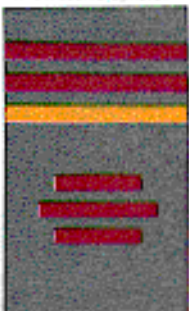

MU-D 2304 A

Table 1-2. Ammunition Color Coding - Continued

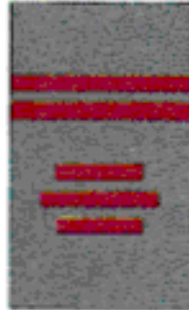
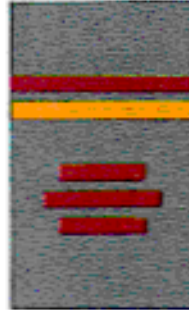
TOXIC (CASUALTY) GAS				NERVE GAS		
PERSISTANT W/EXPLOSIVE BURSTER	PERSISTENT W/D EXPLOSIVE BURSTER	NON-PERSISTENT W/EXPLOSIVE BURSTER	NON-PERSISTENT W/D EXPLOSIVE BURSTER	G & V SERIES W/EXPLOSIVE BURSTER	G & V SERIES W/D EXPLOSIVE BURSTER	BINARY AGENT
3rd Generation						
2nd Generation						
1st Generation						

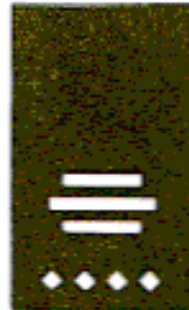
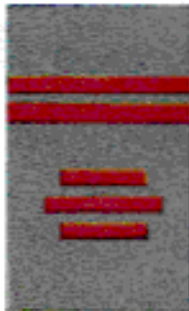
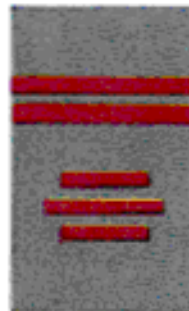

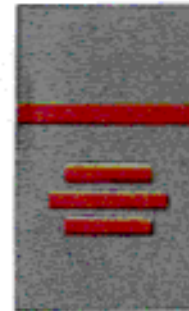

















MU-D 2305 A

Table 1-2. Ammunition color Coding - Continued

INCAPACITATING GAS		IRRITANT (HARASSING) GAS				CANISTER	
W/EXPLOSIVE BURSTER	W/O EXPLOSIVE BURSTER	PERSISTENT W/EXPLOSIVE BURSTER	PERSISTENT W/O EXPLOSIVE BURSTER	NON PERSISTENT W/EXPLOSIVE BURSTER	NON PERSISTENT W/O EXPLOSIVE BURSTER	W/SLUGS	W/FLECHETTES
							
3rd Generation							
							
2nd Generation							
							
1st Generation							







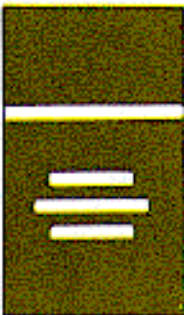

MU-D 2306 A

Table 1-2. Ammunition Color Coding - Continued

INCENDIARY	SMOKE		PRACTICE			TRAINING INERT
	WP & FMPJ W/EXPLOSIVE BURSTER	SMOKE (EXCEPT WP & FMPJ) & COLORED SMOKE	W/HE BURSTER	W/LOW EXPLOSIVE BURSTER	INERT	
						
			3rd Generation			
						
			2nd Generation			
						
			1st Generation			

MU-D 2307 A

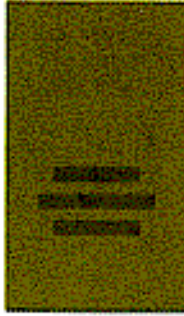
Table 1-2. Ammunition Color Coding - Continued

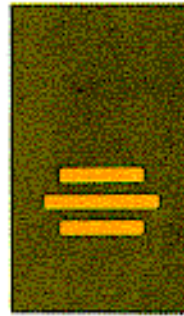
COUNTER MEASURE	ILLUMINATING		ROCKET MOTORS
	SEP. LOADING PROJ.	OTHERS	
			
3rd Generation			
			
2nd Generation			
			
1st Generation			

SYMBOLS

- AP - ARMOR PIERCING
- APC - ARMOR PIERCING CAPPED
- APDS - ARMOR PIERCING DISCARDING SABOT
- APERS - ANTIPERSONNEL
- API - ARMOR PIERCING INCENDIARY
- HE - HIGH EXPLOSIVE
- HEAT - HIGH EXPLOSIVE ANTITANK
- HEI - HIGH EXPLOSIVE INCENDIARY
- HEP - HIGH EXPLOSIVE PLASTIC
- PWP - PLASTICIZED WHITE PHOSPHORUS
- W - WITH
- W/O - WITHOUT
- WP - WHITE PHOSPHORUS

FOOTNOTES

- 1 BOMBS OVER 100 POUNDS HAVE YELLOW NOSE BANDS (OPTIONAL ON SMALLER BOMBS)
- 2 OLDER BOMBS HAVE YELLOW NOSE AND TAIL BANDS AND BLACK MARKINGS
- 3 MARKINGS ON HEI AMMUNITION MAY BE IN BLACK OR RED
- 4 OLDER AMMUNITION IS MARKED WITH ONE GREEN BAND FOR G SERIES, TWO GREEN BANDS FOR V SERIES
- 5 EARLIER MODEL FIRE BOMBS ARE OLIVE DRAB W/ ONE PURPLE BAND AND PURPLE MARKING
- 6 COLOR EFFECTS ARE INDICATED BY THE SYMBOL "C" REPEATED AT LEAST THREE TIMES IN THE COLOR OF THE EFFECT PRODUCED
- 7 ROCKET MOTORS MAY ALSO BE PAINTED WHITE W/ ONE BROWN BAND AND MARKINGS IN BLACK
- 8 THE COLOR ORANGE MAY BE USED TO IDENTIFY AMMUNITION USED FOR TRACKING AND RECOVERY AND IN CERTAIN TRAINING OPERATIONS
- 9 OLDER PRACTICE AMMUNITION MAY BE BLACK OR BLUE OR UNPAINTED, WITH WHITE MARKINGS
- 10 YELLOW BAND APPLIED WHEN PROJECTILE CONTAINS EXPLOSIVE (PROJECTILE FRACTURING) CHARGE

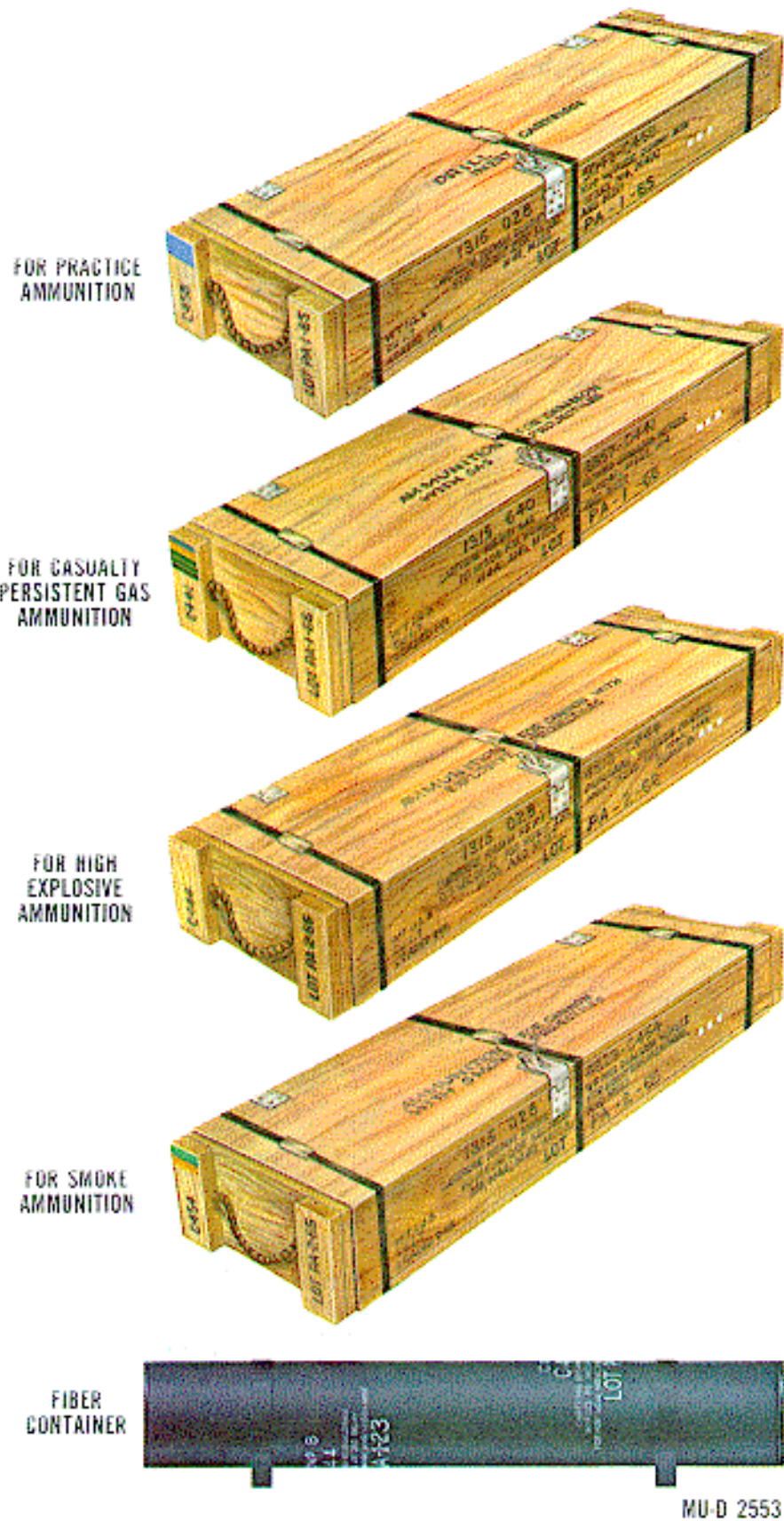

Figure 1-3. Color identification and typical marking of packing and fiber containers.

1-7. Packing and Marking

Ammunition is packed, and packing containers marked (fig. 13) in accordance with pertinent drawings and specifications. Containers are designed to withstand conditions normally encountered in handling, storage, and transportation, and to comply with Department of Transportation (DOT) regulations. Marking of containers includes all information required for complete identification of contents and for compliance with DOT regulations (see also TM 9-1300-206).

1-8. Inspecting and Grading

a. Ammunition is manufactured to rigorous specifications and is thoroughly inspected before acceptance. Ammunition in storage is periodically inspected and tested in accordance with specific instructions of the U.S. Army Munitions Command (USAMUCOM).

b. Each lot of small arms ammunition is graded primarily on qualities that make the lot especially suitable for use in a particular class of weapons, such as aircraft and anti-aircraft machineguns, rifles, and ground machineguns.

c. Other than small arms ammunition is graded, as a result of surveillance tests, on the basis of serviceability and priority of issue. (See the appropriate ammunition serviceability list for grading of specific items.) Stocks of inappropriate grade on hand for immediate use in the field should be transferred from one station to another within the Army command.

1-9. Priority of Issue

a. Subject to special instructions from USAMUCOM, ammunition of appropriate type and model will be used in the following order: limited standard, substitute standard, standard. Within this rule, ammunition with the longest or least favorable storage will be used first. Among lots of equal age, priority of issue will be given the smallest lot.

b. Proper distribution must be made of those items which, because of their scarcity, cost or highly technical or hazardous nature, are characterized as regulated items (In this connection, see AR 711-35.)

c. Priority of issue for given lots of ammunition is published in special instructions and in SB 700-1300-1.

1-10. Precautions

a. Handle explosive ammunition carefully at all times-explosive elements, such as primers and fuzes, are sensitive to shock and high temperature.

b. Store ammunition in original container in dry well ventilated place; protect from direct rays of sun and other sources of excessive heat. Keep sensitive initiators, such as blasting caps, igniters, primers, and fuzes, separate from other explosives.

c. Keep ammunition and its containers clean and dry; protect from damage.

d. Do not disassemble ammunition components, such as fuzes and primers, unless so authorized.

WARNING

Any alteration of loaded ammunition, except as authorized in Paragraph 3-2 of AR 385-63, is hazardous and must not be undertaken.

e. Do not open sealed containers or remove protective or safety devices, except as required for inspection, until just before use.

f. Return ammunition prepared for firing but not fired to its original packing and mark appropriately. Use such ammunition first in subsequent firings in order to keep stocks of opened packings to a minimum.

WARNING

Use of live ammunition for training purposes as a substitute for authorized drill ammunition is prohibited. Such substitution must be considered hazardous and is not permitted under any circumstances.

g. Mark unserviceable ammunition appropriately and return to issuing agency.

1-11. Firing Data

Firing data for ammunition covered in this manual are given in applicable firing tables indexed in DA Pam 310-3.

1-7. Packing and Marking

Ammunition is packed, and packing containers marked (fig. 1-3) in accordance with pertinent drawings and specifications. Containers are designed to withstand conditions normally encountered in handling, storage, and transportation, and to comply with Department of Transportation (DOT) regulations. Marking of containers includes all information required for complete identification of contents and for compliance with DOT regulations (see also TM 9-1300-206).

1-8. Inspecting and Grading

a. Ammunition is manufactured to rigorous specifications and is thoroughly inspected before acceptance. Ammunition in storage is periodically inspected and tested in accordance with specific instructions of the U.S. Army Armament, Munitions and Chemical Command (AMCCOM).

b. Each lot of small arms ammunition is graded primarily on qualities that make the lot especially suitable for use in a particular class of weapons, such as aircraft and antiaircraft machineguns, rifles, and ground machineguns.

c. Other than small arms ammunition is graded, as a result of surveillance tests, on the basis of serviceability and priority of issue. (See the appropriate ammunition serviceability list for grading of specific items.) Stocks of inappropriate grade on hand for immediate use in the field should be transferred from one station to another within the Army command.

1-9. Priority of Issue

a. Subject to special instructions from USAAMCCOM, ammunition of appropriate type and model will be used in the following order: limited standard, substitute standard, standard. Within this rule, ammunition with the longest or least favorable storage will be used first. Among lots of equal age, priority of issue will be given the smallest lot.

b. Proper distribution must be made of those items which, because of their scarcity, cost or highly technical or hazardous nature, are characterized as regulated items.

c. Priority of issue for given lots of ammunition is published in special instructions and in SB 700-1300-1.

1-10. Precautions

a. Handle explosive ammunition carefully at all times-explosive elements, such as primers and fuses, are sensitive to shock and high temperature.

b. Store ammunition in original container in dry well ventilated place; protect from direct rays of sun and other sources of excessive heat. Keep sensitive initiators, such as blasting caps, igniters, primers, and fuzes, separate from other explosives.

c. Keep ammunition and its containers clean and dry; protect from damage.

d. Do not disassemble ammunition components, such as fuzes and primers, unless so authorized.

WARNING

Any alteration of loaded ammunition, except by direction of the technical source concerned and under supervision of a commissioned officer of that service, is hazardous and must not be undertaken.

e. Do not open sealed containers or remove protective or safety devices, except as required for inspection, until just before use.

f. Return ammunition prepared for firing but not fired to its original packing and mark appropriately. Use such ammunition first in subsequent firings in order to keep stocks of opened packings to a minimum.

WARNING

Use of live ammunition for training purposes as a substitute for authorized drill ammunition is prohibited. Such substitution must be considered hazardous and is not permitted under any circumstances g. Mark unserviceable ammunition appropriately and return to issuing agency.

1-11. Firing Data

Firing data for ammunition covered in this manual are given in applicable firing tables indexed in DA Pam 25-30.

THIS PAGE INTENTIONALLY LEFT BLANK

Change 5 1-14

CHAPTER 2 EXPLOSIVE AND CHEMICAL AGENTS

Section I. SOLID PROPELLANTS

2-1. General

Solid propellants are low explosives used to propel projectiles, rockets, etc. Nitrocellulose, though unstable, is a general ingredient of propellants. Stabilizers are added to counteract acid breakdown products of nitrocellulose. Propellant compositions, generally referred to as smokeless powders (a misnomer), burn at characteristic, linear rates affected by initial temperatures and pressures. Propellants are identified by M or T numbers. See TM 9-1300-214 for specific coverage on United States propellants.

2-2. Classification

a. From the viewpoint of composition, modern propellants are classified as follows:

(1) *Single base*. These compositions contain nitrocellulose as their chief ingredient. In addition to a stabilizer, they may contain inorganic nitrates, nitrocompounds and such nonexplosive materials as metallic salts, metals, carbohydrates, and dyes.

(2) *Double base*. A double-base composition contains nitrocellulose and a liquid organic nitrate, such as nitroglycerine, capable of gelatinizing nitrocellulose. Like single-base powders, double-base powders frequently contain additives in addition to a stabilizer.

(3) *Composite*. Composite propellants contain neither nitrocellulose nor an organic nitrate. Generally, they consist of a physical mixture of an organic fuel (such as ammonium picrate), an inorganic oxidizing agent (such as potassium nitrate) and an organic binding agent. A composite propellant has a heterogeneous physical structure.

b. Use of propellant compositions is not in accordance with the foregoing classification. While single-base compositions are used in cannon, small arms and grenades, double-base compositions are used in cannon, small arms, mortars, rockets and jet propulsion units. Composite compositions are used in rocket assemblies and jet propulsion units. Choice of propellant for a specific use is determined by ballistic

and physical requirements, rather than on the basis of composition. As a given composition may be suitable for use in several different applications, it is not practicable to classify propellants on the basis of use.

2-3. Characteristics

a. *Form*. Propellant grains take the form of strips, flakes, balls, sheets or cords; single-perforated or multiperforated cylinders; and rosette cylinders (fig. 2-1). Grains vary in size and form with the weapons. In rockets, for example, grains are considerably larger than those used for artillery. Figure 2-2 shows the relative size of grains used in some artillery propellants. Small grains require no perforation or a single perforation. Larger grains require more equally spaced perforations, usually seven, to provide a greater burning surface. The United States Army and Navy have favored the multiperforated grain form for use in weapons.

b. *Burning*.

(1) *General*. Unconfined, nitrocellulose propellant burns relatively slowly and smoothly but, when confined, its rate of burning increases with temperature and pressure. In order not to exceed the permissible chamber pressure of the weapon in which it is to be used, the rate of burning is proportional to the propellant free to burn (fig. 2-3). Therefore, propellants are made into accurate sizes and definite shapes.

(2) *Degressive burning*. As strips and cords burn, the burning surface decreases continuously until the grain is consumed. Such burning is characterized as degressive.

(3) *Neutral burning*. A single-perforated grain burns in opposite directions. By controlling the initial diameter of the perforation, the total burning surface hardly changes during burning. Such burning is characterized as neutral.

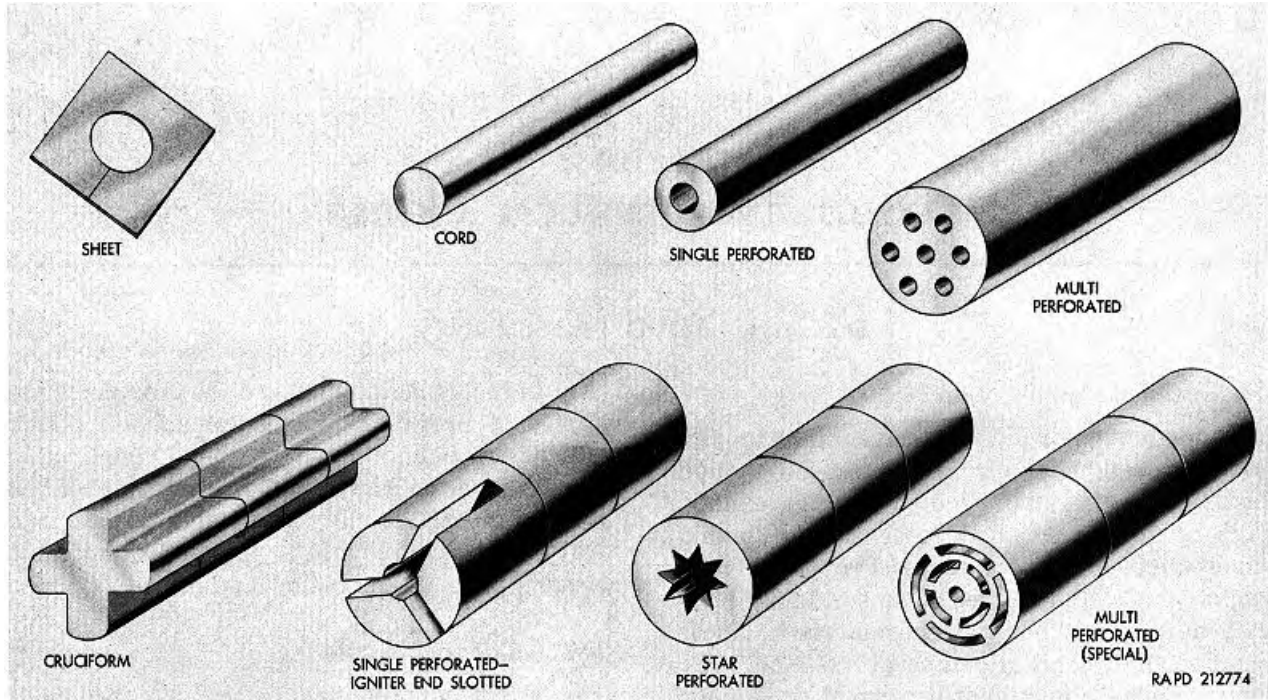

Figure 2-1. Shapes and forms of propellant grains.

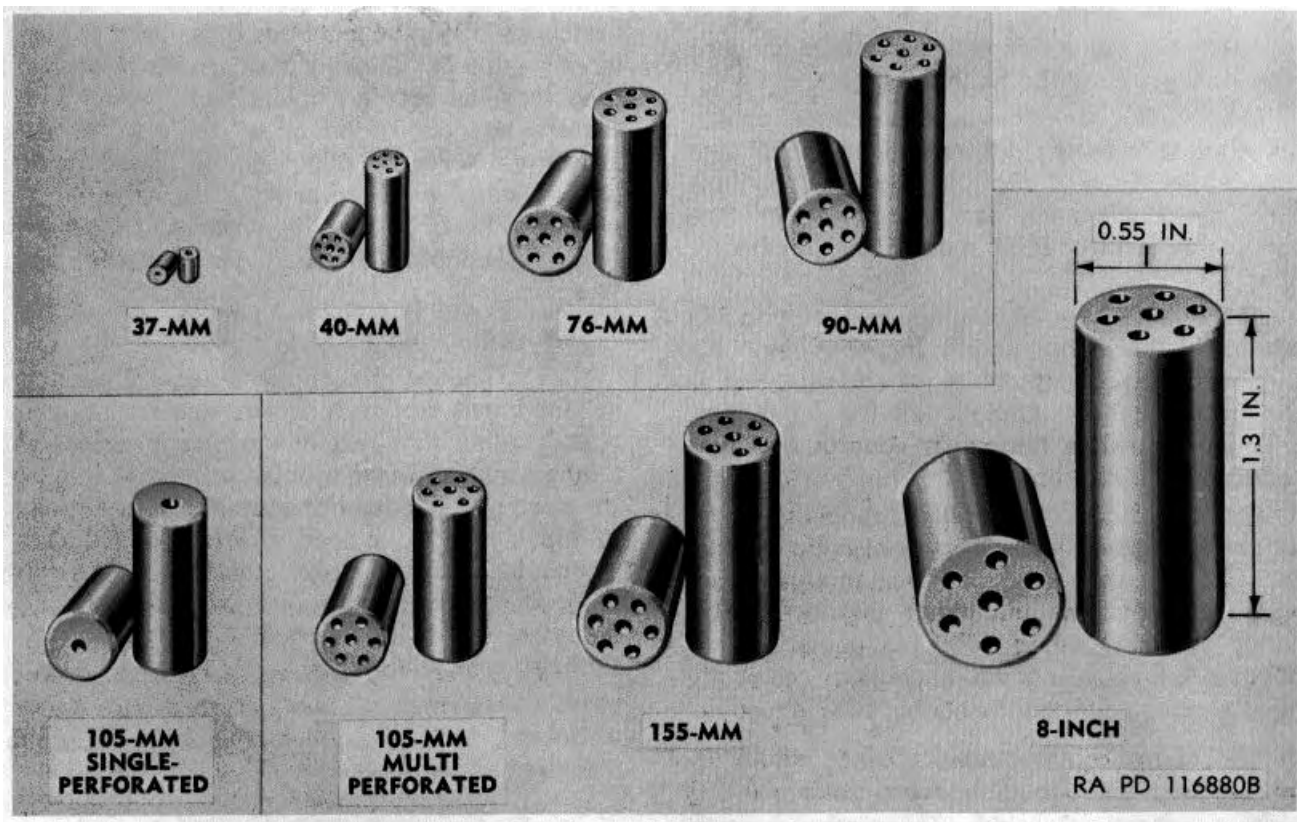

Figure 2-2. Relative sizes of propellant grains.

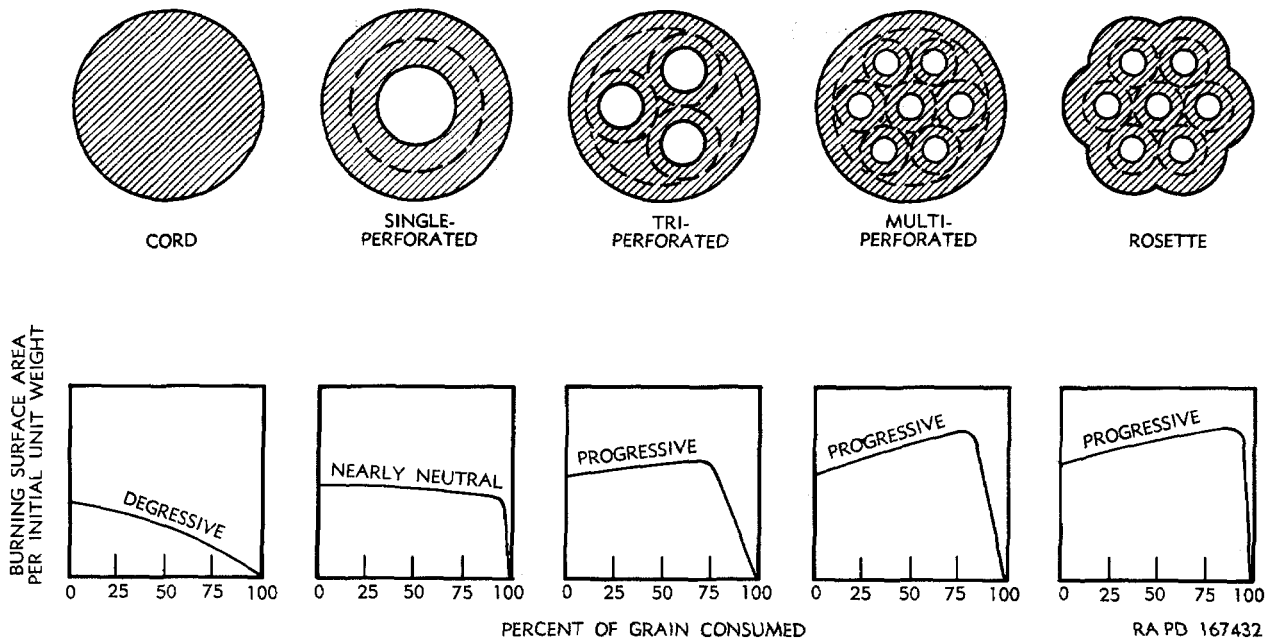
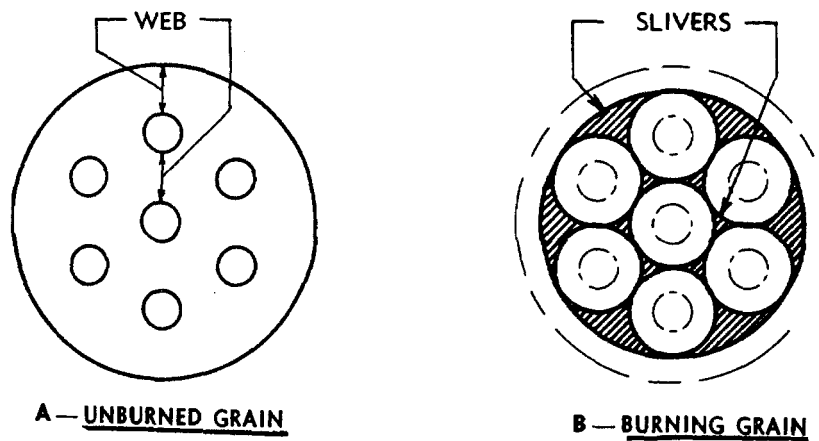

Figure 2-3. Burning of propellant grains.



RA PD 4319A

Figure 2-4. Progressive burning of propellant grains (multi-perforated).

(4) Progressive burning. A triperforated grain can be so designed that the burning surface actually increases until burning is nearly completed and slivers are formed. Such a grain is said to burn progressively. This characteristic can be made more pronounced if the grain is multi-perforated (fig. 2-4). When a multi-perforated grain is not completely consumed, portions of the grain remain in the form of slivers. These may be ejected as such from the weapon. The rosette or Walsh grain, with a scalloped periphery, reduces the amount of slivers produced by a multi-perforated grain.

2-4. Single-Base Propellants

a. *Pyrocellulose Powder.* The first nitrocellulose propellant standardized by the U.S. Army and Navy was termed pyrocellulose powder. As first manufactured, pyrocellulose powder consisted only of carefully purified nitrocellulose gelatinized in a mixture of ether and ethanol and extruded in the form of a cord with one or more perforations.

b. *E.C. Powder.* This partially colloided propellant was one of the earliest nitrocellulose compositions developed. Because it contains some ungelatinized nitrocellulose, E.C. powder is distinctly

more sensitive to friction than completely colloidized powders. Data indicate that the composition is sufficiently sensitive and powerful to be used as a high explosive as well as a propellant. For this reason, the powder has been used in hand grenades as well as in blank ammunition.

c. Flashless and Smokeless Compositions. The class of propellants known as flashless and smokeless (formerly designated as FNH and NH) comprises compositions used chiefly in artillery. Whether a composition is flashless depends upon the gun in which it is used. For example, the M1 composition is flashless when used in a 75-mm gun, but not in the 8-inch gun.

d. Small-Arms Powders. Both single-base and double-base propellants now are used in small arms. The earlier type of single-base powder for this purpose was known as IMR.

2-5. Double-Base Propellants

a. Prior to World War II, double-base propellants were used in the United States for mortar and small-arms ammunition but not in cannon. Since then, double-base compositions have been standardized for use in the smaller guns. Requirements for rocket propellants have resulted in standardization of a number of such compositions.

b. Standard double-base cannon powders are used in the form of perforated grains. Although these propellants have considerably greater ballistic potential than the single-base compositions, they are less stable.

c. Double-base mortar powders include those used for propellant charges and those used in the ignition cartridges, both being in the form of flakes. In general, high nitroglycerine content gives double-base mortar propellant compositions very high ballistic potential values. These compositions, however, are the least stable of the standard propellants. This is due, in part, to the small grain size. Powders having large specific surfaces have been found to give lower test values than those in large grains.

d. Double-base propellants for small arms have been used for many years. At one time, these were of the ballistite type, in flake, disk, and grain forms. However, these compositions have been replaced by double-base compositions containing less nitroglycerine. The single-perforated grains having these compositions are coated with dinitrotoluene or centralite and glazed with graphite. Although they have some that less ballistic potential than the ballistite type of powders, they are more stable, cause less erosion of rifles, and have less tendency to flash.

e. Standardization of the caliber .30 carbine permitted use of a double-base composition in the form of spheres 0.02 or 0.03 inch in diameter, instead of flakes or grains (fig. 25). Commonly called ball powder, this composition is produced by dissolving wet nitrocellulose in a solvent (e.g., ethyl acetate), adding diphenylamine and chalk, and then nitroglycerine. Upon agitation and addition of a protective colloid, the solution is dispersed in the form of small globules. When the volatile solvent is removed by heating, the powder solidifies in the form of spherical pellets. A wide variety of single-base or double-base compositions may be produced by this process.

f. Essentially all propellants for rockets are of the double-base or composite type, as are those for rocket motors. Rocket propellants are manufactured in much larger grains than the largest cannon powder grains, and rocket motor grains are manufactured in very large sizes. The smallest rocket powder is 0.37 inch in diameter and 4.15 inches long. Rocket motor grains may exceed 12 inches in diameter and 6 feet in length. The smaller grains of rocket powder are manufactured by the solvent process. The larger grains are produced by rolling sheeted powder into a carpet roll, which is then extruded.

(1) Solid propellants for rockets are primarily of two types. The more common type is a double-base composition consisting principally of

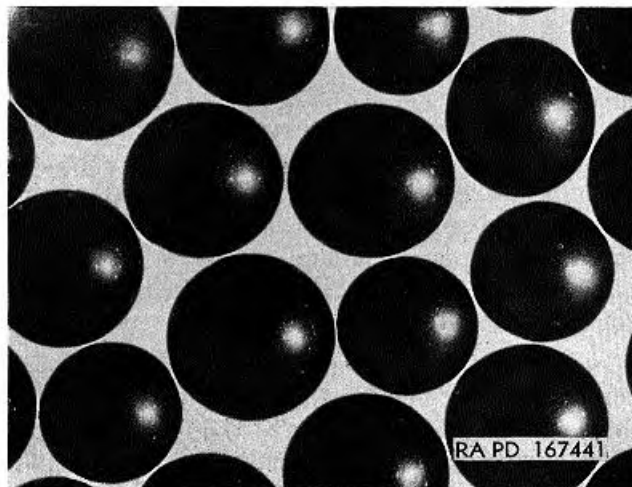

Figure 2-5. Ball powder, X25.

a colloided mixture of nitrocellulose and nitroglycerine. The other type consists of a mixture of an organic fuel, an inorganic oxidizing agent and a binding agent. In either case, the mode of burning and the limitations under which the compositions are used are the same.

(2) Most rocket motors accommodate maximum pressures developed by the propellants of the order of 3,500 psi. When the propellant charge is ignited, pressure within the rocket chamber generally increases within 0.0005 to 0.05 second. Maximum value of this pressure is determined by burning rate of the propellant and diameter of the nozzle orifice. Thereafter, the charge burns at a nearly constant rate. Steady-state pressure is maintained constant or decreases very slowly until the propellant is completely consumed.

2-6. Composite Propellants

a. Difficulty In manufacturing double-base rocket and rocket motor propellants in large grains coupled with undesirable ballistic effects with change in initial temperature have led to the development of composite propellant. Containing no nitrocellulose or

nitroglycerine, composite propellant is a mixture of an organic fuel, an inorganic oxidizing agent and an organic binding agent.

b. A representative composite propellant is the T9 composition, which consists of the following:

Ammonium picrate	40.7
Potassium nitrate	40.8
Ethyl cellulose	4.6
Chlorinated wax	4.6
Calcium stearate	0.5

Such a composition can be manufactured by a simple mixing operation and can be molded in the desired form by pressing. While it has a desirably low temperature sensitivity, with respect to the burning rate, the composition tends to become brittle and crack when subjected to low temperatures. It therefore cannot be used safely at temperatures below -12° C. (10° F.). A further disadvantage is the relatively large amount of white smoke produced when the propellant is burned.

of the fuel with the oxidizer (hydrazine with nitric acid, for example) or by such external influences as electrical spark ignition or catalysts.

Section II. LIQUID PROPELLANTS

2-7. General

Liquid propellants, which can be better controlled in combustion than solid propellants, have been developed for large rockets, missiles and projectiles. Such propellant compounds are either composite (fuel and oxidizer combined) or independent (fuel and oxidizer in separate containers). The propellant reacts rapidly to produce gaseous products which can propel the rockets at supersonic velocities

2-8. Classification

Liquid propellants are classified by the type of reaction system, as follows:

a. *Monopropellant.* This system consists of fuel and oxidizer stored in one tank, and delivered by a pump or pressurized tank for eventual reaction in the chamber of a rocket. To initiate, a separate source of ignition is required.

b. *Bipropellants.* These systems consist of an organic fuel and an oxidizer, in separate containers, for dual feed, carburetion and combustion within the reaction chamber. Reaction may be initiated by contact

2-9. Characteristics

Burning rate and specific impulse of solid propellant are controlled by propellant composition and grain design In liquid propellant rockets, however, the fuel/oxidizer mix can be adjusted in flight to regulate the burning rate and specific impulse. Like some chemical agents and explosives, liquid propellants are hazardous, toxic, flammable, sensitive and inherently dangerous.

2-10. Materials

Listed below are the most common combustible and flammable materials used as fuels and oxidizers with liquid propellants:

a. *Fuel-alcohols* (ethyl, methyl, furfural); hydrocarbons (kerosene, aviation gasoline, octane, heptane, pentane); aniline, monoethylaniline, hydrazine, diborane, pentaborane, liquid hydrogen and anhydrous ammonia.

b. *Oxidizer-white fuming* and red fuming, nitric acids (WFNA and RFNA); oxygen, hydrogen peroxide, chlorine trifluoride and dinitrogen tetroxide.

Section III. LOW EXPLOSIVES

2-11. General

Rates of transformation of explosives have been found to vary greatly. One group, which includes smokeless and black powders, undergoes combustion at rates that vary from a few centimeters per minute to approximately 400 meter per second. These are known as low explosives. Some high explosives (e.g., nitrocellulose) can, by physical conditioning, be rendered capable of functioning as a low explosive when ignited.

a. Definition. An explosive is a material that can undergo very rapid self-propagating decomposition, with formation of more stable materials, liberation of heat, and development of a sudden pressure effect. An explosive may be solid, liquid or gaseous. It may be a chemical compound, a mixture of compounds, or a mixture of one or more compounds and one or more elements. Military explosives are chiefly solids or mixtures formulated to be solid at normal temperatures.

b. Deflagration. If a particle of an explosive reaches a temperature at which the rate of decomposition becomes significant, deflagration or spattering of the particles from the surface occur prior to decomposition. At a characteristic temperature, heat output is sufficient for the reaction to proceed and be accelerated without input of heat from another source. At this temperature, called the ignition temperature, deflagration, a surface phenomenon, begins. Gaseous reaction products flow away from the unreacted material below the surface. Deflagration of all the particles in a mass of finely divided explosive occur almost simultaneously. In a confined space, pressure increases, which, in turn has the effect of increasing the rate of reaction and temperature. The final effect of deflagration under confinement is explosion, which may be violent deflagration or even detonation. In the case of low explosives, such as loose black powder and pyrotechnic compositions, only violent deflagration can take place. Nitrocellulose propellants can burn, or if confinement is sufficient, deflagrate so rapidly as to detonate.

c. Characteristic. To qualify for military use, a low explosive (propellant) must evidence the following:

- (1) A controlled burning rate.
- (2) Capability for instant ignition and combustion.

- (3) Stability over extended periods of storage under normal conditions.

- (4) Balance for complete combustion, producing a minimum amount of residue and weapon-bore erosion.

- (5) Minimal toxic and explosive hazard.

- (6) Capability of withstanding mechanical shock incident to loading, transportation and handling by commercial and military carriers.

d. Low-Explosive Train. An explosive train consists of combustibles and explosives arranged according to decreasing sensitivity. This arrangement serves to transform a small impulse into one sufficiently large to function a main charge. A fuze explosive train, for example, may consist of primer, detonator, delay, relay, lead and booster charge, one or more of which may be omitted or combined. Addition of a bursting charge renders such a train a bursting charge explosive train (fig. 2-6). A propelling charge explosive train (fig. 2-6), on the other hand, may consist of primer, igniter (or igniting charge-usually black powder) and some type of propellant.

- (1) Small-arms ammunition (cartridges) explosive trains have percussion primers, relatively small propelling charges and no igniter. Initially, the firing pin explodes the primer. The flame then passes through the vent leading to the powder chamber and ignites the propelling charge. Expansion of the resultant gases ejects the bullet.

- (2) In artillery ammunition, the low explosive train includes an auxiliary charge of black powder, called the primer charge or igniter charge. The auxiliary charge between the primer and the propelling charge is necessary to intensify the small flame produced by the primer composition sufficiently to initiate combustion of the large quantity of propellant. As in fixed ammunition, the primer or igniter charge may be contained in the body of the primer. This makes one assembly of the percussion element of the primer and the primer charge. Otherwise, the primer or igniter charge may be divided between the primer body and the igniter pad attached to separate-loading propelling charges.

- (3) In jet propulsion weapons (rockets and rocket motors), the low-explosive train consists of propelling charge (single-perforated or multiperforated grain of double-base or composite propellant), igniter (usually a black powder mixture) and initiator (electric squib or squibs).

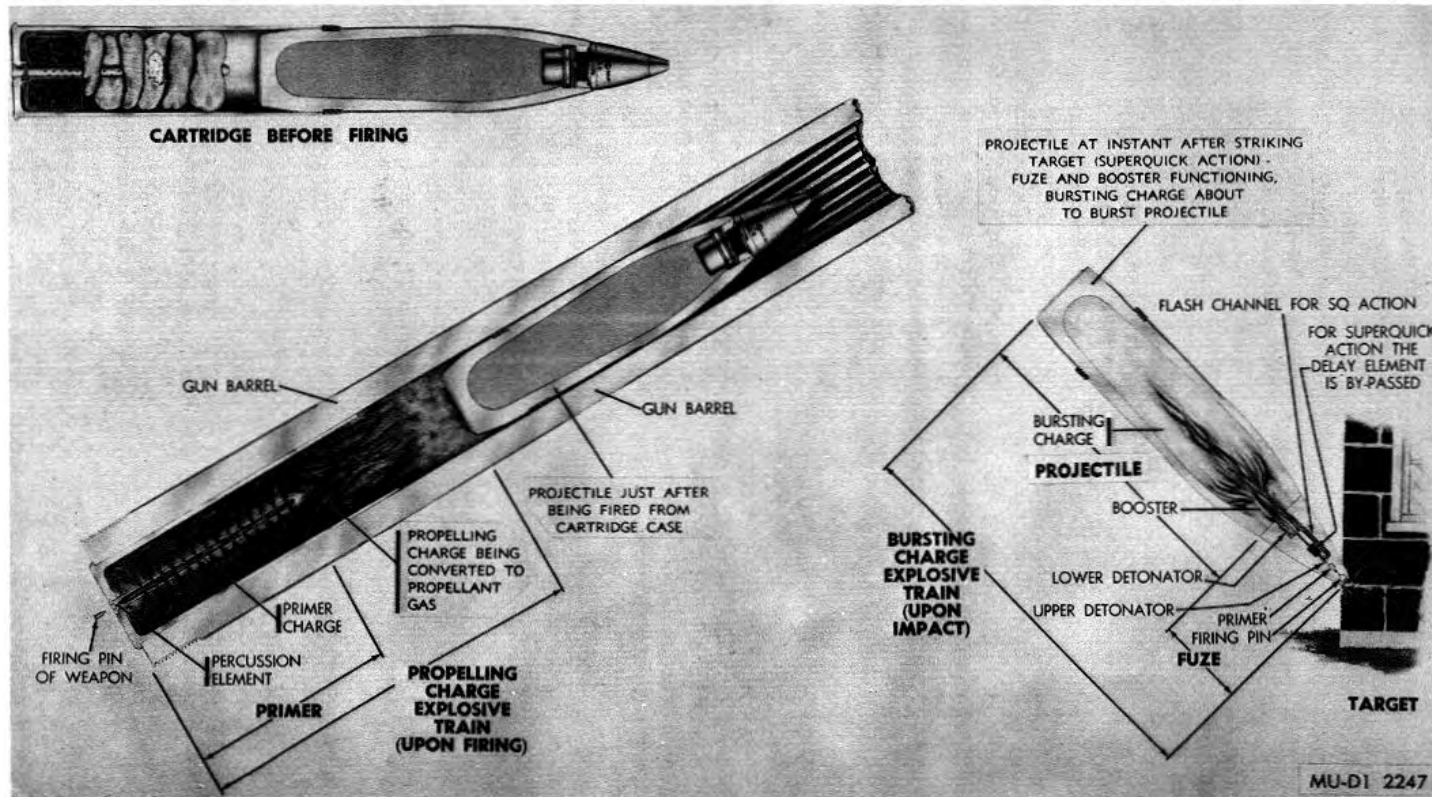

Figure 2-6. Explosive trains-artillery ammunition.

2-12. Black Powder

a. *General.* Black powder, the name originally applied to a mixture of charcoal, sulfur, and potassium nitrate, now applies also to compositions containing bituminous coal instead of charcoal, and sodium nitrate instead of potassium nitrate.

(1) Standard black powder contains 74.0 ± 1.0 percent potassium nitrate, 15.6 ± 1.0 percent charcoal, and 10.4 ± 1.0 percent sulfur. Its principal combustion products are CO₂, CO, N₂, K₂CO₃, K₂SO₄, and K₂S.

(2) The sodium nitrate black powder used for military purposes and blasting operations has the following composition:

Percent Sodium nitrate.....	72 ± 2
Charcoal	16 ± 2
Sulfur	12 ± 2

The grains of powder are glazed with graphite.

b. *Characteristics.* In appearance, black powder varies from a very fine powder to dense pellets. These may be black, or grayish-black because of a graphite-glazed surface.

(1) *Burning rate.* The type of charcoal used in manufacture of black powder is reflected by the burning rate of the powder. Black powder made -from willow or alder charcoal burns much more rapidly than that made from oak charcoal. An increase in burning rate also results from confining black powder. Decrease in burning rate, on the other hand, is caused by the following:

- (a) Increase in percentage of nitrate with corresponding decrease in percentage of charcoal.
- (b) Presence of more than 0.2 percent of moisture.
- (c) Simple mixing (rather than milling) of ingredients.
- (d) Substitution of sodium nitrate for potassium nitrate.

(2) *Granulations.* Military black powder is manufactured in a range of grain sizes: from coarser than 4 mesh to finer than 200 mesh. Sodium nitrate black powder for military use is granulated in three classes: A, B and C, according to particle size. Military applications of sodium nitrate black powder include the following:

Powder class	Use
A	Saluting charges
B	Practice bombs
C	Torpedo impulse charges

(3) *Sensitivity.* Black powder is less sensitive than tetryl, but is very sensitive to ignition by flame, incandescent particles or electric spark. Black powder ignites spontaneously, for example, at about +300°C. (+540°F.). Sodium nitrate black powder is slightly less sensitive to impact than potassium nitrate black powder.

(4) *Stability and moisture absorption.* In the absence of moisture, black powder is highly stable. Its ingredients are essentially nonreactive with each other, even at +120°C. (+250°F.). Heating black powder above +70°C. (+160°F.) tends to vaporize the sulfur. This results in a change in composition or uniformity of composition. Black powder picks up moisture more because of the charcoal present than because of the moisture-absorbing nitrate. While moisture does not cause black powder to become unstable, it can react with and corrode such metals as steel, brass and copper. When sodium nitrate is substituted for potassium nitrate a composition is obtained that picks up moisture more readily than potassium nitrate black powder. Both black powders are comparable in stability.

c. *Uses.* Black powder finds application in ignition of rocket and missile propulsion units, primers, delay elements, bursting charges, saluting charges, spotting charges, expelling charges, bursters, igniters, smoke-puff charges and catapult charges. Other uses include the following:

(1) *Ignition.* Black powder is used for ignition charges for smokeless powder. The grains are glazed with graphite. Burning of black powder produces many finely divided, incandescent solid particles. These make black powder a better igniting material for smokeless powder than finely divided smokeless powder itself.

(2) *Fuzes.* Black powder is used for loading the time-train rings of fuzes. The grains of fuze powder are not glazed with graphite. Because fuze powder having the standard composition burns too rapidly for use in some fuzes, a slow-burning powder is used having the following composition:

	<i>Percent</i>
Potassium nitrate	70.0 ± 1.0
Semibituminous coal.....	14.0 ± 1.0
Sulfur.....	16.0 ± 1.0

Like fuze powders having the standard composition, slow-burning fuze powders is not glazed with graphite.

(3) *Special fuses.* Black powder used in manufacture of time blasting or safety fuse may have the standard black powder composition, be a modification of the proportions of the ingredients of this, or contain such inert diluents as graphite, brick dust or borax. The most common type of fuse burns at a rate of about 1 foot in 40 seconds.

(4) *Squibs*. Squibs for military use are caused to function by heat developed by an electrical resistance wire. This may ignite a charge of either potassium nitrate or sodium nitrate black powder, or an ignition composition, and, in turn, the main charge of black powder. In some cases, the black powder charge is ignited by a matchhead composition.

d. Precautions. Black powder, which is very sensitive to friction, heat and impact, is one of the most dangerous explosives to handle. It will deteriorate rapidly on absorption of moisture but retains its explosive properties indefinitely if kept dry. Black powder may be desensitized by placing it in water. Discarding the water separately from the residue, however, permits wet black powder to dry out and regain some of its explosive properties. Combustible materials which have absorbed liquids leached from black powder constitute a severe fire hazard and may become explosive.

2-13. Black Powder Substitutes

a. Benite. Benite is used in igniter compositions of artillery primers or in base igniter bags for separate-loading ammunition. Benite takes the form of extruded strands of black powder (KNO₃, charcoal, sulfur) embedded in nitrocellulose.

b. Eimite. Eimite is another substitute for black powder in artillery primers. When used in initiating type elements, delays and similar components, eimite takes the form of solid granulation.

c. Boron-Potassium Nitrate. Boron-potassium nitrate is used in many ignition applications. As an igniter composition, it is used in granular form, or as pellets. Its function in a delay element is to ignite and set off the rest of the explosive train at a predetermined time.

d. Mox-Type Mixtures. Mox-type mixtures are filler explosives, not igniter materials. Although classified as explosives, these mixtures are used for specialized applications. The most common mixture, MOX 2B, is used as a spotting charge in place of black powder. Unlike other filler explosives, MOX 2B was developed commercially.

2-14. Pyrotechnic Compositions

a. General. Standard military pyrotechnic compositions consist of such compounds as perchlorates and nitrates to provide oxygen; powdered metals for fuel; salts of sodium, barium or strontium for color; and binding and waterproofing materials. These compositions are sensitive to heat, flame, static electricity discharges and, particularly, to friction. Those

containing chlorates are especially hazardous as regards to fires and explosions. Because they contain powdered metals, pyrotechnic compositions may become hazardous in the presence of moisture.

b. Main Charge Pyrotechnic Compositions.

(1) The earliest pyrotechnic compositions consisted of varying constituents of black powder: charcoal, sulfur and niter (potassium or sodium nitrate). Other materials, such as iron filings, coarse charcoal or realgar (arsenic sulfide), were added to produce special effects. Many other materials were added or substituted as additional knowledge was acquired.

(2) Present-day pyrotechnic compositions generally consist of various chemicals. In some cases, a single material may perform more than one of the functions in (a) through (f) below.

(a) Oxidizers, such as chlorates, perchlorates, peroxides, chromates and nitrates, provide oxygen for burning. Additional oxygen may be obtained from the air. Nongaseous powders, such as barium chromate-boron mixtures, which do not require oxygen from the air, are used in delay columns.

(b) Fuels, such as aluminum and magnesium powder, their alloys, sulfur, lactose and other easily oxidizable materials.

(c) Combustible binding and waterproofing agents, such as shellac, linseed oil, resins, resinates and paraffin.

(d) Color intensifiers, such as polyvinyl chloride, hexachlorobenzene or other organic chlorides, mixed with barium and copper salts to produce green, or with strontium salts to produce red.

(e) Dyes, such as methylaminoanthraquinone to produce red, and auramine to produce yellow.

(f) Coolants, such as magnesium carbonate and sodium bicarbonate.

(3) Pyrotechnic smoke compositions are of two general types:

(a) Those that burn with practically no flame but give off a dense, colored smoke as a combustion product.

(b) Those that burn at a temperature so low that an organic dye ((2)(e), above) in the composition will volatilize instead of burn and, therefore, color the smoke.

(4) A friction igniter consists of a primer cup and a ripple wire. The primer cup contains a mixture of potassium chlorate, charcoal and dextrin binder. The ripple wire is coated with red phosphorus in shellac and has a nitrocellulose coating. The wire extends through the primer cup.

(5) Quickmatch is a term applied to strands of cotton soaked in a mixture of black powder and gum Arabic and coated with mealed powder. It is used as an initiator to transmit flame to igniting, priming or pyrotechnic charges.

(6) The priming charge is a dried black powder paste in intimate contact with the firstfire composition. Newer pyrotechnic items use a special nonhygroscopic priming paste containing barium nitrate, zirconium hydride, silicon, tetranitrocarbazole and a plastic binder.

(7) The first-fire composition is generally a mechanical mixture of illuminant charge and black powder. However, for certain items, it may be a special nonhygroscopic, easily ignitable composition that burns with a higher temperature.

c. Characteristics. Pyrotechnic compositions are generally compressed into definite shapes or forms. On ignition and combustion, these compositions produce considerable light and decompose or burn by a process known as deflagration. Functional characteristics of pyrotechnic compositions include candlepower, burning rate, color, color value and efficiency of light production. Other important characteristics are sensitivity to impact and friction, ignitability, stability and water absorption. Table 2-1 shows burning performance characteristics of black powder, nitrocellulose composition and pyrotechnic compositions.

d. Uses. Pyrotechnic compositions are used in items of ammunition to produce, through chemical reaction, a desired effect or combination of effects, such as light (instantaneous or continuous), smoke, heat, noise, delay timing and gas pressure. These items are used for such purposes as signaling, illumination, simulation of battlefield effects, warning, marking, tracking, screening, igniting, and incendiary effects. Pyrotechnic items produce their effect by burning and are consumed in the process. The effect produced generally falls into one of the following pyrotechnic classes:

- (1) Photoflash cartridges. These produce a single flash of light for photographic purposes.

Table 2-1. Characteristics of Low Explosives

	Burning rate		Heat liberated	Temperature developed
	In minutes	In seconds.	Cal/GM	°C
Pyrotechnic compositions	2-14	----	500-2,500	800-3,500
Black powder	----	4	655	2,700
Nitrocellulose compositions	----	7-12	700-1,300	1,700-3,300

(2) *Flares.* A flare produces illumination, generally of high candlepower and substantial duration. Flares may be parachute supported, towed or stationary, while their primary function is illumination, they may be used for identification, ignition, locating, or warning.

(3) *Signals.* There are two types of effects obtained with signals: light and smoke. A particular model may produce both effects. Light producing signals are much smaller and faster burning than flares. They may consist of a single parachute-supported star or one to five freely falling stars, with or without colored tracers. Smoke signals are of either the slow-burning, streamer type, which leaves a trail of smoke, or the parachute-suspended type, which produces a cloud of smoke.

(4) *Simulators.* Simulators, which duplicate battle sounds and flashes of light produced by service items of ammunition, are designed for use in training.

(5) *Miscellaneous types.* Pyrotechnics other than those in (1) through (4), above, have a variety of uses.

(a) In illuminating artillery ammunition, the pyrotechnic elements are assembled in artillery projectile bodies. The projectiles are used in conjunction with other artillery ammunition (TM 43-0001-28).

(b) Smoke grenades have the form of high-explosives hand and rifle grenades but resemble smoke signals in effect (TM 9-1330-200-12 and TM 9-1330-200-34).

e. *Precautions.* Pyrotechnic compositions contain materials of a hazardous nature. Although the ingredients themselves may be relatively stable, any one of them may, in time, react with

one or more of the other materials in the mixture to cause detonation. Some pyrotechnic compositions (mixtures) may become more sensitive because of exposure to moisture. Mixtures are sensitive to heat,

flame, friction and static electrical discharges from the human body.

Section IV. HIGH EXPLOSIVES

2-15. General

High explosives are usually nitration products of such organic substances as toluene, phenol, pentaerythritol, amines, glycerin, and starch. Otherwise, high explosives may be nitrogen-containing inorganic substances or mixtures. A high explosive may be a pure compound or an intimate mixture of several compounds with additives, such as powdered metals (aluminum), plasticizing oils, waxes, etc., which impart desired stability and performance characteristics. A high explosive is characterized by the extreme rapidity with which its decomposition occurs. This is known as detonation. When initiated by a blow or shock, high explosives will decompose almost instantaneously, either in a manner similar to extremely rapid combustion or with rupture and rearrangement of the molecules themselves. In either case, gaseous and solid products of reaction are produced. The disruptive effect of the reaction makes some explosives valuable as a bursting charge but precludes their use as a propellant. This is due to the fact that the gases formed would develop excessive pressures that might burst the barrel of the weapon.

a. Terms and Definitions.

(1) *Primer*. A primer is a relatively small and sensitive initial explosive train component which, on being actuated, initiates functioning of the explosive train. The primer itself will not reliably initiate high-explosive charges. In general, primers are classified by method of initiation, such as percussion, stab, electric, friction, chemical, etc.

(2) *Detonator*. A detonator is an explosive train component that can be activated by a nonexplosive impulse or action of a primer. A detonator is capable of reliably initiating secondary high explosive charges. When activated by a nonexplosive impulse, a detonator includes the function of a primer. In general, detonators are classified, according to the method of initiation, as percussion, stab, electric, friction, flash, chemical, etc.

(3) *Igniter*. An igniter is definable as follows:

(a) A device containing a composition, usually in the form of black powder, which burns readily. Such an igniter is used to amplify initiation of a primer in functioning of a fuze.

(b) A device containing a spontaneously combustible material, such as white phosphorus, used to ignite fillings of incendiary bombs and flamethrower fuels at the time of dispersion or rupture of the bomb casing.

(c) A device used to initiate burning of the fuel mixture in a rocket combustion chamber.

(4) *Delay*. A delay is an explosive train component that introduces a controlled time delay in functioning of the train.

(5) *Relay*. A relay is an element of a fuze explosive train that augments an otherwise inadequate output of a prior explosive component. Thus, a relay reliably initiates a succeeding train component. Relays, in general, contain a small single explosive charge, such as lead azide, and are not usually employed to initiate high-explosive charges.

(6) *Lead*. A lead is an explosive train component that consists of a column of high explosive, usually small in diameter. A lead transmits detonation from one detonating component to a succeeding high-explosive component. It is generally used to transmit detonation from a detonator to a booster charge.

(7) *Booster charge*. A booster charge is the final high-explosive component of an explosive train that amplifies the detonation from the lead or detonator. Thus, a booster charge reliably detonates the main high-explosive charge of the munition.

(8) *Fuze explosive train*. A fuze explosive train is an arrangement of a series of combustible and explosive elements consisting of a primer, a detonator, a delay, a relay, a lead and a booster charge, one or more of which may be either omitted, or combined. The explosive train serves to accomplish controlled augmentation of a relatively small impulse into one of sufficient energy to cause the main charge of the munition to function.

(9) *Primer compositions*. A primer composition is an explosive that is sensitive to a blow, such as that imparted by a firing pin. A primer composition transmits shock or flame to another explosive, a time element or a detonator. Most mil

itary priming compositions consist of mixtures of one or more initial detonating agents, oxidants, fuels, sensitizers and binding agents. Many compositions contain potassium chlorate, lead thiocyaate, calcium silicide, antimony sulfide, lead azide, lead styphnate, mercury fulminate and a binding agent. The potassium chlorate acts as an oxidizing agent; the lead thiocynate and calcium silicide act as the fuel, and as desensitizer to the chlorate; and the explosive acts as the detonating agent. Other materials, such as ground glass and carborundum, may be added to increase sensitivity to friction. Priming compositions for electric primers and squibs may contain barium nitrate as the oxidizing agent instead of potassium chlorate, and lead styphnate or DDNP (diazodinitrophenol) as the initiating explosive. Primer mixtures are used in percussion elements of artillery primers, in fuzes and in small-arms primers, and as the upper layer of a detonator assembly.

(10) Bursting charge. This is an encased explosive designed to break the metal casing into small fragments.

b. *High-Explosive Train.* An explosive train is a means by which a small amount of energy is

built up sufficiently to assure a high-order detonation for a bursting charge. Fundamentally, an explosive train consists of a detonator, booster and bursting charge. This sequence is often interrupted by a delay or relay. The example of a 2,000-pound bomb filled with TNT, with a fuze of the firing pin type, illustrates the principle of the explosive train. The TNT by itself will not detonate from release of the firing pin. This is so because the initial source of energy, a friction or percussion effect of the firing pin, is insufficient and must be stepped up to where it will detonate the TNT. This is always accomplished by means of an explosive train, as follows:

(1) When initiated by stab action of a firing pin or by a flame, the detonator sets up a high-explosive wave. This wave is so small and weak that it will not initiate a high-order detonation in the bursting charge unless a booster is placed between the two. The booster picks up the small explosive wave from the detonator and amplifies it. The bursting charge is thus initiated and a high-order detonation results (fig. 2-6 and 2-7).

(2) To gain control of the time and place at which an explosive will function, it is necessary to

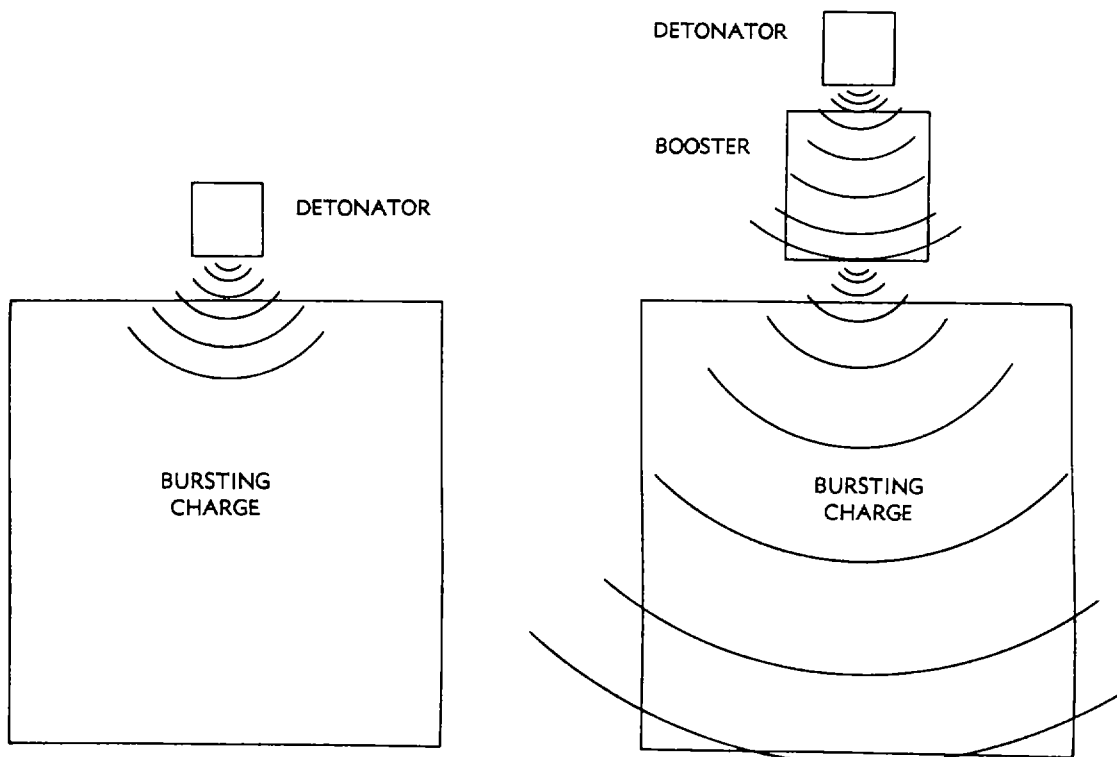

RA PD 15182

DETONATING WAVE AMPLIFIED BY USE OF BOOSTER

Figure 2-7. Detonating wave amplified by use of a booster.

Incorporate other components in a high-explosive train. The action desired may be a burst in the air, a burst instantly upon impact with the target, or a burst shortly after the projectile has penetrated the target. The components to give these various actions may be a primer, a black powder delay pellet or train, an upper detonator or any combination of these components. Arrangement of the components does not change the basic chain. Other components are simply placed in front of the basic chain (fig. 2-8).

(3) Placing a primer and a black powder time train in front of the basic chain causes a projectile to burst in air. When the projectile leaves the weapon (or the bomb is dropped), the primer ignites the time-train rings. After the time-train rings burn the requisite time, the primer initiates action of the detonator, booster and bursting charge (schemes A and C, fig. 2-8).

(4) To burst the projectile promptly upon impact with the target, a superquick or instantaneous action is necessary. This action is usually obtained by placing an upper detonator in the extreme front of the fuse, and lower detonator in the body near the booster charge. The detonating wave is thus transmitted instantly to the bursting charge (scheme D, fig. 2-8).

(5) To permit the projectile to penetrate the target, a delay action is necessary. This is obtained by placing a primer and delay element ahead of the detonator. In some cases, this combination of primer and delay is inserted between an upper and lower detonator (scheme E, fig. 2-8).

(6) A variation of the high-explosive train is found in chemical projectiles. In this train, there is no large bursting charge. It is only necessary to rupture the projectile and allow the chemical contents to escape. Actual bursting of the projectile is accomplished by an enlarged booster, known as a burster charge, contained in a tube running through the center of the projectile.

2-16. Classification

High explosives are classified according to their sensitivity as initiating, booster and bursting explosives

a. Initiating. Initiating high explosives are extremely sensitive to shock, friction and heat. Under normal conditions, they will not burn, but will detonate if ignited. Their strength and brisance are inferior, but are sufficient to detonate high explosives. Because of their sensitivity, they are used in munitions for initiating and intensifying high-order explosions. Mercury fulminate, lead azide, lead styphnate and diazodinitrophenol are examples of such explosives.

b. Booster. Explosives of this type include tetryl, PETN and RDX. They have intermediate sensitivity between initiating explosives and explosives used as bursting charges. Booster explosives may be ignited by heat, friction or impact and may detonate when burned in large quantities.

c. Bursting. Bursting explosives include explosive D, amatol, TNT, tetryl, pentolite, picratol, tritonal, composition B, DBX, HBX and others.

2-17. Demolition and Fragmentation Explosives

a. Tetryl.

(1) *Characteristics.* Tetryl 2, 4, 6 - trinitrophenylmethylnitramine is a fine yellow crystalline material. When heated, it melts, decomposes and then explodes. It burns rapidly, is more easily detonated than TNT or ammonium picrate (explosive D) and is much more sensitive than picric acid. It is detonated by friction, shock or spark. It is insoluble in water, practically nonhygroscopic. Tetryl is stable at all temperatures that may be encountered in storage. It is toxic when taken internally; on contact, it discolors skin tissue (resembles tobacco stain) and causes dermatitis.

(2) *Detonations.* Brisance tests show tetryl to have a very high shattering power. Tetryl is greater in brisance than TNT and is exceeded in standard military explosives only by PETN and RDX.

(3) *Uses.*

(a) *Charges.* Tetryl is the standard booster explosive and is sufficiently insensitive when compressed to be used safely as a booster explosive. Violence of its detonation assures a high-order detonation of the bursting charge. Tetryl is used in the form of pressed pellets. It is the standard bursting charge for small-caliber (20-mm and 87mm) projectiles. It produces appreciably better fragmentation of these projectiles than TNT. It is also more readily detonated, and yet, in small-caliber cartridges, withstands the force of setback in the weapon. It is also a constituent of tetrytol.

(b) *Detonator.* When it is used in detonators, tetryl is pressed into the bottom of the detonator shell and covered with a small priming charge of mercury fulminate, lead azide or other initiator.

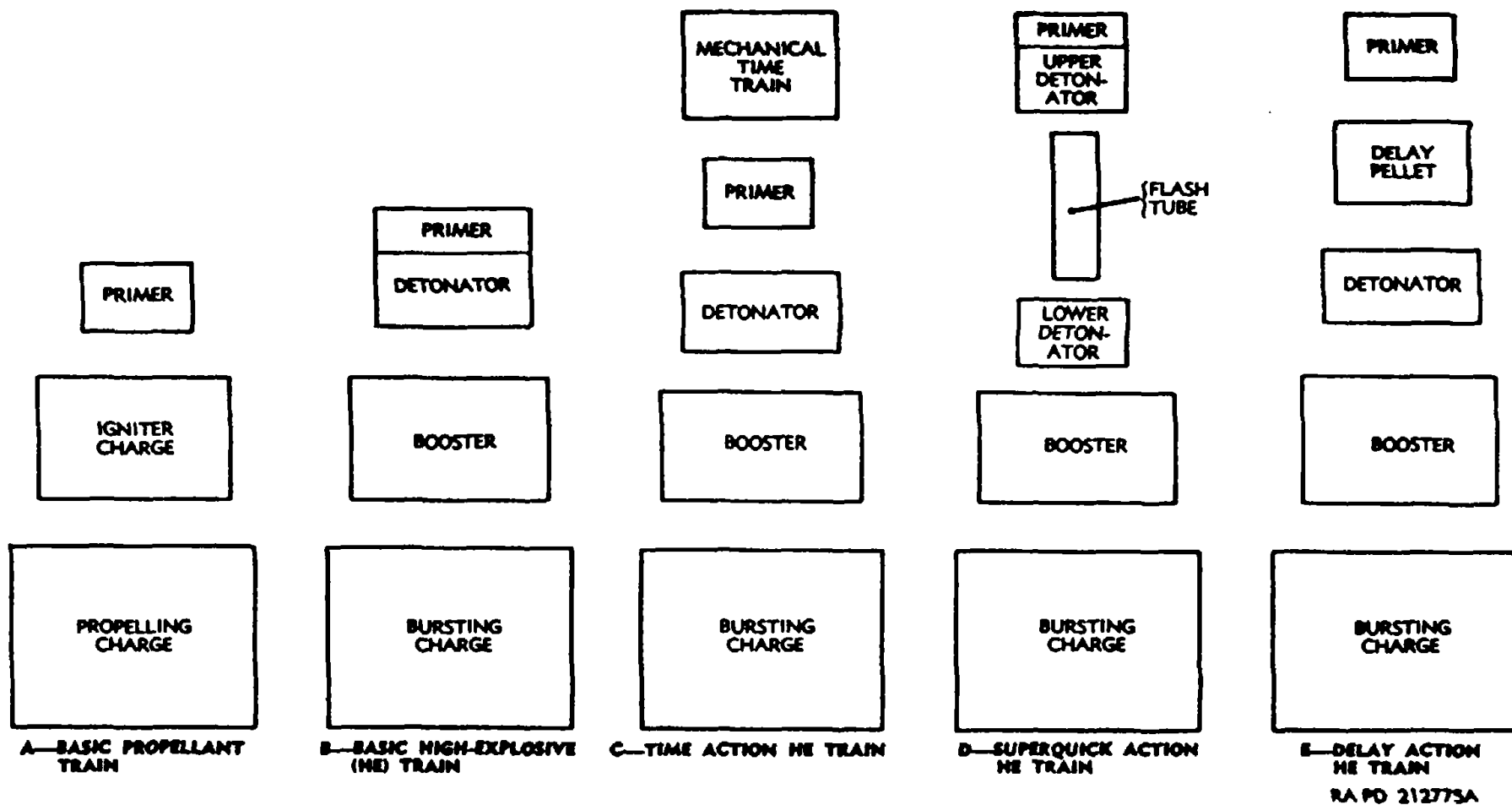

Figure 2-8. Schematic arrangement of explosive train components

b. *PETN (Pentaerythritol Tetranitrate)*. PETN is one of the strongest high explosives known. It is more sensitive to shock or friction than TNT or tetryl. In its pure form, PETN is a white crystalline powder; however, it may turn light gray from impurities. It will detonate under long, slow pressure. PETN in bulk must be stored wet. Its primary use is in booster and bursting charges in small-caliber ammunition; in upper detonators in some land mines and projectiles; and as the explosive core of primacord detonating fuze. It may be issued in sheet form. Suspended in TNT, with which it forms a pentolite explosive of high brisance.

c. *RDX*. RDX, cyclotrimethylenetrinitramine, one of the most powerful explosives, is commonly known as cyclonite; hexogen (German); T4 (Italian); and Tanoyaku (Japanese). It is a white crystalline solid having a melting point of +202°C. (+397°F.) and is very stable. It has slightly more power and brisance than PETN. It is more easily initiated by mercury fulminate than is tetryl. RDX has been used mainly in mixtures with other explosives, but can be used by itself as a subbooster, booster, and bursting charge. It is also combined with nitrohydrocarbons, which permit cast-loading, or with waxes or oils for press-loading. It has a high degree of stability in storage.

d. *TNT (Trinitrotoluene)*. The 2, 4, 6-trinitrotoluene, commonly known as TNT, is a constituent of such explosives as amatol, pentolite, tetrytol, tritonal, picratol and composition B.

(1) *Characteristics*. TNT in a refined form is one of the most stable of high explosives. It is relatively insensitive to blows or friction and can be stored for long periods of time. Confined TNT, when detonated, explodes with violence. When ignited by a flame, unconfined TNT burns slowly, does not explode, and emits a heavy, oily, black smoke; however, burning or rapid heating of large quantities, especially in closed vessels, may cause a violent detonation. TNT is nonhygroscopic and does not form sensitive compounds with metals. It is, however, readily acted upon by alkalis to form unstable compounds that are very sensitive to heat and impact. TNT usually resembles a light brown sugar; in the pure state, it is crystalline and nearly white. When melted and poured into a projectile or bomb, it forms a solid crystalline explosive charge. TNT is a very satisfactory military explosive. The melting point of standard grade 1 TNT is 80.2°C. (+176°F.). Ammunition loaded with TNT can be stored, handled, and shipped with comparative safety.

(2) *Exudation*. When stored in warm climates or during warm summer months, some ammunition loaded with TNT may exude an oily brown liquid. This exudate oozes out around the threads at the nose of the projectile and may form a pool on the floor. The exudate is flammable and may contain particles of TNT. Pools of exudate should be removed.

(3) *Detonation*. TNT in crystalline form can be detonated readily by a No. 6 blasting cap or, when highly compressed, by a No. 8 blasting cap. Cast TNT requires a booster charge of compressed tetryl or an explosive of similar brisance to assure complete detonation.

(4) *Uses*.

(a) *Bursting charge*. TNT is used as a bursting charge for high-explosive rounds and bombs, either alone or in a mixture, such as tritonal or composition B. TNT is also used in mines and for parts of certain rounds and bomb bursters. Flake TNT is used in fragmentation hand grenades.

(b) *Demolition*. TNT is used to demolish bridges, railroads, fortifications and other structures. For such purposes, it is used in the form of a large shaped charge or a small, highly compressed block inclosed in a waterproof fiber container. This protects the TNT from crumbling in handling. Triton blocks used by the Corps of Engineers are of pressed TNT inclosed in cardboard containers.

(c) *Blasting*. TNT is suitable for all types of blasting. It produces approximately the same effect as an equal weight of dynamite of 50 to 60 percent grade. TNT is also used as a surround in some amatol-loaded ammunition.

e. *Amatol*.

(1) *General characteristics*. Amatol, a mixture of ammonium nitrate and TNT in various percentages, has the same general characteristics as TNT. Amatol is crystalline, yellow or brownish, and insensitive to friction. However, it may be detonated by severe impact. It is less sensitive to detonation than TNT, but is readily detonated by mercury fulminate and other detonators. Amatol is hygroscopic and, in the presence of moisture, attacks copper, brass and bronze, forming dangerously sensitive compounds. Amatol 50/50 has approximately the same rate of detonation and brisance as TNT, while 80/20 amatol is slightly lower in velocity and brisance than TNT. Amatol 80/20 produces a white smoke on detonation, and amatol 50/50 produces a smoke less dark than straight TNT.

(2) *Composition and form.* Amatol 50/50 consists of 50 percent ammonium nitrate and 50 percent TNT by weight. When hot, amatol is sufficiently fluid to be poured or cast like TNT. Amatol 80/20 consists of 80 percent ammonium nitrate and 20 percent TNT. It resembles wet brown sugar. When hot, it becomes semiplastic (like putty) and can be pressed into rounds and bombs.

(3) *Uses.* Amatol is a substitute for TNT. Except for 80/20 amatol, amatols are obsolete. The primary use of 80/20 amatol is in bangalore torpedoes.

f. Picric Acid (Trinitrophenol).

(1) *General.* Picric acid, 2, 4, 6-trinitrophenol, a nitrated product of phenol under the name of melinite, was adopted as a military high explosive by the French in 1886. It has been used more extensively as a military explosive by foreign nations than by this country. The British designate it as lyddite.

(2) *Characteristics.* Picric acid is a lemon-yellow crystalline solid. It is stable but reacts with metals when moist, in some cases forming extremely sensitive compounds. Picric acid is more readily detonated by means of a detonator than TNT but has about the same sensitivity to shock. It is not so toxic as TNT. Although slightly soluble in water, picric acid is nonhygroscopic. Picric acid has a high melting point—approximately +122°C. (+251.6°F.).

g. Ammonium Picrate (Explosive D).

(1) *Characteristics.* Ammonium picrate is the least sensitive to shock and friction of all military explosives. This makes it well suited for use as a bursting charge in armor-piercing projectiles. A product of picric acid, it is slightly inferior in explosive strength to TNT. When heated, it does not melt but decomposes and explodes. It reacts slowly with metals; however, when wet, it may form sensitive and dangerous compounds with iron, copper and lead. It is difficult to detonate. When ignited in the open, it will burn readily like tar or resin.

(2) *Special precautions.*

(a) Ammonium picrate removed from a round is much more sensitive to shock or blow than fresh ammonium picrate. In contact with lead, iron or copper it forms sensitive compounds.

(b) Although less sensitive than TNT, ammonium picrate can be exploded by severe shock or friction. It is highly flammable and may detonate when heated to a high temperature.

(3) *Uses.* Explosive D is used as a bursting charge for armor-piercing rounds and in other types of projectiles that must withstand severe shock and stress before detonating.

h. Picratol. Picratol is a mixture of 52 percent explosive D and 48 percent TNT. It can be poured like straight TNT and has approximately the same resistance to shock as straight explosive D. The brisance of picratol is between that of explosive D and TNT. Picratol is nonhygroscopic. Picratol is a standard filler employed for all Army semi-armor-piercing bombs.

i. Pentolite. Pentolite, a 50/50 mixture of PETN and TNT also known as pentol (German) and pentritol, has largely been displaced by composition B. Pentolite should not be drilled to form booster cavities; forming tools should be used. It is superior to TNT in explosive strength and is less sensitive than PETN. Pentolite may be meltloaded and is satisfactory for the following uses:

(1) As a bursting charge in small-arms ammunition (e.g., 20-mm).

(2) In shaped-charge ammunition of many types (e.g., antitank, rifle grenades and bazookas).

(3) In some ammunition, as a booster or booster-surround.

(4) In rockets and shaped demolition charges.

j. Tetrytol. Tetrytol is a uniform mixture of 65 to 75 percent tetryl and the remainder TNT. Tetrytol has higher brisance than TNT and is more effective in cutting through steel and in demolition work. It is less sensitive to shock and friction than tetryl and only slightly more sensitive than TNT. Tetrytol is nonhygroscopic and is suitable for underwater demolition, since submergence for 24 hours does not appreciably affect its characteristics. Tetrytol is used in chain and individual demolition blocks and in certain destructors. Tetrytol is stable in storage but exudes at +65°C. (+149°F.).

k. Nitrostarch Explosives.

(1) *Characteristics.* Nitrostarch is nitrated starch. Obtained from corn, tapioca and similar starchy material, it is used to sensitize combustibles and oxidizing agents in much the same manner that nitroglycerin is used in dynamite. It is gray, highly

flammable, can be ignited by the slightest spark, and burns with explosive violence. Nitrostarch is less sensitive than dry guncotton or nitroglycerin. As a demolition explosive, it is as insensitive to impact as explosive D and as sensitive to initiation as TNT. Nitrostarch explosives are readily detonated by a No. 6 blasting cap.

(2) *Uses.* A nitrostarch demolition explosive has been adopted as a substitute for TNT. It is available in 1-pound blocks, 1/2-pound blocks, and 1/4-pound units. Each 1/4-pound unit contains three 1/12-pound pellets (briquets) wrapped in paraffined paper, with markings to indicate the location of holes for the blasting caps. TNT formulas for computing small charges are directly applicable to the nitrostarch demolition explosive. It should be noted that fragmented blocks may cause detonation.

l. Dynamite. Commercial blasting explosives, with the exception of black powder, are referred to as dynamite. There are several types, each subdivided into a series of grades, all differing in one or more characteristics. Dynamite consists essentially of nitroglycerin absorbed in a porous material. Each composition generally is designated as straight, ammonia, gelatin or ammonia-gelatin dynamite. It is available in paraffin-coated, 1/2-pound sticks or cartridges, rated according to the percent, by weight, of nitroglycerin content.

(1) *Characteristics.* Dynamite of from 50percent to 60-percent nitroglycerin content is equivalent (on an equal weight basis) to TNT in explosive strength. Dynamite of 40-percent nitroglycerin content is equivalent to TNT in the ratio of 11/4 pounds dynamite to 1 pound TNT. Straight dynamite is more sensitive to shock and friction than TNT and is capable of being detonated by a rifle bullet. Generally, the higher percentages of dynamite have very good water resistance. Explosion of the common types of dynamite produces poisonous fumes, which are dangerous in confined places. Dynamite, as well as other nitroglycerin explosives, is adversely affected by extreme cold. Nonfreezing dynamite (NG type) freezes at -30°C. (-22°F.); low-freezing dynamite freezes at 0°C. (+32°F.); and 60-percent NG dynamite freezes at +10°C. (+50°F.).

(2) *Uses.* Dynamite is used as a substitute for nitrostarch or TNT for training purposes. It is also employed by the Corps of Engineers for trench, harbor, dam, flood control, and mining demolitions. The following restrictions apply:

(a) Not to be issued or used for destruction of duds.

(b) Not to be supplied for training in use of demolition equipment.

(c) Not to be used in coastal defense submarine mines or mine batteries.

(d) Not to be carried in combat vehicles subject to extremes of temperature.

m. Tritonal. Tritonal is a generic term for explosives containing TNT and powdered aluminum, generally in the ratio of 80/20. Because of the aluminum powder, inclusion of moisture in the mixture must be avoided. Tritonal is used in light-case and general purpose bombs. It produces a greater blast effect than TNT or composition B.

n. HBX. HBX compositions (HBX-1, HBX-3, and H6) are aluminized (powdered aluminum) explosives used primarily as a replacement for the obsolete explosive, torpex. They are employed as bursting charges in mines, depth bombs, depth charges, and torpedoes. HBX-1 consists of 40 percent RDX, 38 percent TNT, 17 percent aluminum and 5 percent desensitizer. HBX-3 consists of 31 percent RDX, 29 percent TNT, 35 percent aluminum, and 5 percent desensitizer. H-6 consists of 45 percent RDX, 30 percent TNT, 20 percent aluminum, and 5 percent desensitizer. HBX-1 compares with torpex in brisance, but is less sensitive to impact and initiation. HBX-3 and H-6 have lower sensitivity to impact and much higher explosion test temperatures than torpex.

o. Composition A. Originally, composition A was a semiplastic mixture containing 91 percent RDX and 9 percent beeswax. When the beeswax was replaced by a wax derived from petroleum, and the method of adding the desensitizer changed, the designation was changed to composition A-2. Recently, the composition has been redesignated as composition A-3, because of changes in granulation of RDX and method of manufacture. Composition A-3 is granular in form, resembling tetryl in granulation. It is usually buff colored and is press-loaded in 20-mm, 37-mm and 40-mm cartridges. It is 30 percent stronger than TNT, its strength depending on the amount of wax binder. It is used as a filler for HEP rounds.

p. Composition B. Composition B (comp B) is a 60/39/1 mixture of RDX, TNT and desensitizer. Its color varies from dirty white to light yellow to brownish yellow. It is less sensitive than tetryl but more sensitive than TNT. It is intermediate between TNT and RDX with respect to sensitivity and initiation. It is only inferior to

triton and torpex with respect to blast effect. Composition B is an authorized filler for Army-Navy (AN) standard aircraft bombs, mines, torpedoes, antitank artillery ammunition (76-mm and 105-mm), demolition charges and rockets. Composition B containing 60 percent RDX and 40 percent TNT, exclusive of wax, is known as composition B2, a nonstandard explosive. Because of its greater sensitivity to impact, composition B2 is less suitable than composition B for use in bombs. Composition B4, used as a burster in chemical projectiles, consists of a 60/39.5/0.5 mixture of RDX, TNT and calcium silicate.

q. Composition C (Series).

(1) *General.* Composition C, sometimes referred to as PE, is a plastic explosive, an 88/12 mixture of RDX and a nonexplosive plasticizer composition. It is brown, plastic in form, and about the consistency of putty. It has a tendency to leach (sweat) out plasticizing oils, leaving pure RDX, which is too sensitive for use in the field.

(2) *Composition C2.* This putty-like composition is an 80/20 mixture of RDX and an explosive plasticizer composition. It is approximately 35 percent stronger than TNT, and was developed as a replacement for composition C as a demolition charge.

(3) *Composition C3.* This is a yellowish, putty-like mixture of 77 percent RDX and 23 percent of an explosive plasticizer. It is slightly inferior to composition B as an explosive for producing blast effect, and is considerably less sensitive than TNT. It may not always be detonated by a No. 8 blasting cap, but can be detonated by the special Corps of Engineers blasting cap. It was designed to replace Composition C2, and is used principally as a commando and demolition explosive or as a filler in some types of munitions. If its plasticity is lost by long storage at low temperatures, it may be restored to satisfactory plasticity by immersion in warm water and molding with the hands. It must not be exposed to open flame, as it catches fire easily and burns with an intense flame. If burned in large quantities, the heat generated may cause it to explode. Its explosion produces poisonous gases in such quantities that its use in closed spaces is dangerous. It is hygroscopic, volatile at elevated temperatures and hardens at temperatures below -29°C. (-20 F.).

(4) *Composition C4.* This is a 91/9 mixture of RDX and plastic nonexplosive composition. It is a semiplastic, putty-like material, dirty white to light brown

in color, less sensitive, more stable, less volatile, and more brisant than composition C3. It is a nonhygroscopic material that has found application in demolition blocks and specialized uses. It hardens below -57°C. (-70°F.) and exudes when stored above +77°C. (+170°F.).

r. HMX (Cyclotetramethylene tetranitramine) is almost as powerful as RDX, but is seldom used by itself in military explosive applications. It is usually mixed with a compound, such as TNT. Variations of such compositions, their properties and uses follows:

- (1) Octol 70/30 (70% HMX/30% TNT)
- (2) Octol 75/25 (75 % HMX/25%o TNT)
- (3) HTA-3 (49%o HMX/29% TNT/22% Aluminum)
- (4) Both octols and HTA-3 are used for HE filler in projectiles and bombs.

2-18. Initiating and Priming Explosives

a. Lead Azide. Lead azide, one of the most stable initiators, is used to detonate high explosives. Because of its superior properties, it has replaced mercury fulminate. Lead azide flashes at much higher temperatures, stands up better in storage, and is less hazardous to manufacture. A smaller amount of lead azide is required than mercury fulminate to detonate an equal amount of TNT. Dextrinated lead azide (93%o lead azide, 4% lead hydroxide and 3 % dextrin and impurities), used for military purposes rather than crystalline (pure) lead azide, is a white-to-beige, powder-like material which can be compressed. Lead azide is used in primer mixtures, detonators and fuzes.

b. Lead Styphnate. This explosive, 2, 4, 6-trinitroresorcinate, is widely employed commercially and as an initiator for both foreign and domestic explosives. It is pale straw, deep yellow, orange-yellow or reddish-brown in color. Lead styphnate is slightly less sensitive to impact than mercury fulminate and has about the same strength and stability as lead azide. However, lead styphnate is more easily ignited by an electrical spark than is mercury fulminate, lead azide, or DDNP. As a primer, lead styphnate produces a very good flame. It should be stored under water in conductive rubber containers. In primer compositions, lead styphnate offers sensitivity, stability, and ample flame. It is incapable of initiating the detonation of any of the military high explosives except PETN.

c. *Diazodinitrophenol (DDNP)*. Extensively employed in commercial blasting caps, this explosive serves in military priming compositions and detonators. It is nonhygroscopic and greenish yellow to brown in color. It is extremely sensitive to impact; however, its sensitivity to friction is about that of lead azide. If pressed into a blasting cap shell with a reinforcing cap, and a piece of black powder safety fuse is crimped in

the shell, a charge of DDNP undergoes detonation when ignited. DDNP is a better initiator of the less sensitive high explosives (explosive D and cast TNT). For the more sensitive high explosives, DDNP is not superior to lead azide. It is used to some extent in loading fuze detonators and the manufacture of priming compositions.

Section V. CHEMICAL AGENTS

2-19. General

A military chemical agent is a substance that produces a toxic (casualty) or an irritating (harassing) effect, a screening smoke, an incendiary action, or a combination of these. For specific information on chemicals, see FM 3-7.

2-20. Classification

Chemical agents are compounds and mixtures other than pyrotechnics and are used as fillers in artillery and mortar ammunition, grenades, rockets and bombs. They are classified according to tactical use, physiological effect and purpose, as follows.

a. *Military Gases*. A military gas is any agent or combination of agents that can produce either a toxic or irritating physiological effect. It may be in solid, liquid or gaseous state, either before or after dispersion. The gases may be persistent (remaining effective at point of release for more than 10 minutes) or nonpersistent (becoming ineffective within 10 minutes). Persistent gases are further divided into moderately persistent (remaining effective in the open 10 minutes to 12 hours) and highly persistent (remaining effective in the open longer than 12 hours). Military gases are classified in accordance with their toxic and irritating effects as follows:

(1) *Casualty gases*:

Blister gases.
Choking gases.
Blood and nerve poisons.

(2) *Training and riot control gases*:

Vomiting.
Tear gases.

b. *Screening Smokes*. A screening smoke is a cloud that consists of small particles of solids, liquids, or both, dispersed and suspended in air.

c. *Incendiaries*. An incendiary may be a solid, liquid, or a gelled semiplastic material. By their intense heat and flame, incendiaries can start fires, scorch combustible and noncombustible materials, injure and incapacitate personnel.

d. *Simulated Military Gases*. These agents are essentially mild, nontoxic, irritants (substitutes for the real agents). They are designed specifically for training purposes.

2-21. Blister Gases (Casualty)

Blister gases are agents that affect the nose, throat, eyes, lungs and exposed skin tissue. They harass, and produce casualties from inflammation, blisters and destruction of body tissue. The principal gases in this group are mustard, mustard mixtures, nitrogen mustards and lewisite.

a. *Mustard Gas (H)*. Mustard gas (2,2' dichlorodiethylsulfide) is a dark brown liquid that slowly evaporates to a colorless gas having the odor of garlic. Its principle physiological effect is to produce skin blisters, although the blistering does not actually appear for several hours after contact. If inhaled, mustard gas vapors have a choking, lung-irritating effect. Both protective masks and clothing are necessary for complete protection. Tactically, mustard gas and its mixtures are used to neutralize areas, contaminate materiel, restrict aggressor movement, and inflict casualties. Except as indicated below, these characteristics are common to all mustard derivatives and mixtures.

b. *Distilled Mustard (HD)*. Distilled mustard is similar to pure mustard gas except that it has less odor, greater blistering power, and is more stable in storage.

c. *Nitrogen Mustards (HN-1, HN-2, HN-3)*.

(1) HN-1 (2,2' dichloro-triethylamine), ranges from a colorless, to pale yellow liquid with a faint odor varying from fishy to musty. Both the liquid and the vapor are dangerous and, because virtually odorless, harmful effects may be produced without warning. HN-1 attacks the respiratory tract, as H gas does, but to a lesser degree. It has specially dangerous effects on the eyes and may cause permanent injury or blindness.

(2) HN-2 (2,2' dichloro-diethyl-methylamine) is somewhat more toxic than HN-1. HN-2 has a somewhat fruity odor, is highly unstable, and is no longer considered a chemical agent.

(3) HN-3 (2,2"-trichlorotriethylamine) has no odor when pure.

d. Mustard-T Mixture (HT). HT is a mixture of 60 percent HD and 40 percent T. T, a sulfur and chlorine compound similar in structure to HD, is a clear, yellowish liquid with an odor similar to HD. HT has a strong, blistering effect. It is more stable than HD, has a more enduring effectiveness, and a lower freezing point.

e. Lewisite Gas (L). Lewisite [dichloro (2chlorovinyl) arsine] is a dark brown liquid that evaporates to a colorless gas having the odor of geraniums. In addition to being a blister and choking gas, it acts as an arsenical poison. Protective masks and clothing are necessary for complete protection. Lewisite is best destroyed by bleach, DANC solution or an alcoholic solution of caustic soda. If it is destroyed by burning, there is danger of contaminating the atmosphere with poisonous arsenic oxide. The tactical use of Lewisite and the methods of projection are the same as those for mustard gas. Lewisite renders food and water permanently unfit for use.

f. Mustard-Lewisite Mixture (HL). A variable mixture of HD and L, HL provides a low-freezing mixture for use in cold weather operations or as a high-altitude spray. Its odor is predominantly garlic-like.

2-22. Choking Gases

a. Choking gases affect the nose, throat and lungs of unprotected personnel. They cause casualties resulting from a lack of oxygen. The principal gases in this group are phosgene and diphosgene.

b. Phosgene (CG) appears on initial dispersion as a whitish cloud. It changes to a colorless gas with an odor similar to green grass or new-mown hay. In high concentrations, one or two breaths may be fatal in a few hours. CG produces only a slight irritation of the sensory nerves in the upper air passages; therefore, any personnel exposed to this gas are likely to inhale it more than they would equivalent concentrations of other olfactory sensitizing gases. Phosgene is insidious in its action; consequently, personnel exposed to it often have

little or no warning symptoms until it is too late to avoid serious poisoning. CG as a chemical agent can be employed effectively at very low temperatures, since it freezes only below -155°F.

c. Diphosgene (DP)

(trichloromethylchloroformate) is a colorless liquid with an odor similar to new-mown hay or green corn.

2-23. Blood and Nerve Poisons

Blood and nerve poisons, when absorbed by the blood stream, affect the nervous system, respiratory system and muscular functions of the body. Temporary or permanent paralysis or instant death results. These poisons can immobilize aggressor forces by rendering them helpless.

a. Nerve gases are usually colorless to light brown at the point of release. Their odor is faint, sweetish, fruity or nonexistent. On exposure, personnel experience nausea, vomiting and diarrhea. These effects are followed by muscular twitching and convulsions. Because of extreme toxicity, even extremely low concentrations of these gases act rapidly and effectively. Protection requires impermeable clothing and the protective mask.

b. Hydrocyanic acid (AC) is a colorless gas upon release. Its odor is faint and similar to that of bitter almonds or peach kernels. It is not readily detected in the field. On exposure, personnel experience a rapid stimulation of the respiratory system followed by deeper inhalation. Death by paralysis of the respiratory system may occur in a few minutes.

c. Cyanogen chloride (CK) is a colorless liquid. On release in the field, it changes into a colorless gas about twice as heavy as air. CK sometimes may be faint in odor; otherwise, its odor is sharp and pungent. On contact or exposure, CK will irritate flesh and stimulate a strong flow of tears. Its action is rapid after inhalation, producing paralysis of the respiratory system. Unlike AC, it first produces an involuntary spasm (a warning of its presence) of short duration of the upper respiratory tract.

d. GB (Sarin) (methylisopropoxyfluorophosphine oxide) is a fast-acting, colorless liquid with approximately the same volatility as water. It has a scarcely detectable odor. Intake into the body is by inhalation, absorption or ingestion. GB causes blurred vision, spasms, mental confusion, convulsions and death.

e. VX is an odorless nerve agent similar to GB. Its effectiveness, however, lasts for a longer period.

2-24. Training and Riot Control Gases

Chloroacetophenone and liquid mixtures of chloroacetophenone in hydrocarbon solvents are the principal vomiting and tear gases. They are used for training and riot control. When vaporized or dispersed, they take the form of suspended particles in the atmosphere. They cause partial or complete temporary disability of personnel.

a. Chloroacetophenone (CN), a common tear gas, has a fruity, apple blossom odor and is typical of such agents. It is a solid material, white to black in color. When converted into a gas, gas-aerosol, or finely divided particles, it will cause a profuse flow of tears, unless a protective mask is worn. CN in normal concentrations has no permanent injurious effect on the eyes. In high concentrations, it irritates the skin, producing a burning and itching sensation. Food and water contaminated by CN possess a disagreeable taste. CN is the principal constituent in the filler used in CNC, CNS, CNB mortar rounds and CNC and CN-DM grenades. It can be used in bursting-type munitions in arctic regions.

b. CNC is a liquid chloroacetophenone solution with an odor like chloroform. It causes a profuse flow of tears and skin irritation. It consists of a 30 percent solution of chloroacetophenone in chloroform.

c. Tear gas solution CNB is a 10 percent solution of chloroacetophenone in equal parts of benzene and carbon tetrachloride. It is a less severe lacrimator and skin irritator than CNS. CNB is used as a filler in hand grenades, artillery and mortar projectiles, bombs and aircraft spray for training purposes. It has a characteristic fruity-benzene odor.

d. Tear gas solution CNS is a 23.2 percent solution of chloroacetophenone in equal parts of chloropicrin and chloroform. CNS has an odor similar to flypaper. The protective mask is effective against CNS and CNB. CNS as well as CNB can be used in grenades, mortar projectiles, small bombs and aircraft spray.

e. CS (O-chlorobenzolmalononitrile) is a white crystalline powder having a pepper-like odor. The pure crystalline form is used as a filler for burning-type grenades. A mixture of 5 percent crystalline agent and 5 percent silica gel is used as a filler for bursting-type grenades and in all bulk irritant dispersers. Physiological effects include extreme burning of the eyes accompanied by a copious flow of tears, coughing, difficulty in breathing, and dizziness.

f. Adamsite (DM) (diphenylamine chloroarsine) typifies the vomiting gases. It is a yellow or green solid when pure. It is dispersed by burning type munitions, such as candles and grenades, and appears as a yellow smoke having an odor like coal smoke. Physiologically, it causes lacrimation, violent sneezing, intense headache, nausea and temporary physical debility. For protection, a protective mask is required. DM has only a slight corrosive effect on metals. It renders food and water permanently unfit for use. Arctic conditions impose no special limitations on DM or its mixture with CN (CN-DM burning mixture) when dispersed by hand grenade.

g. CN-DM mixture (chloroacetophenone and diphenylamine chloroarsine) is a solid mixture of CN and DM with a burning ingredient, nitrocellulose. When ignited, the mixture emits an irritating, yellowish white smoke. CN-DM vapors cause headache, nausea, sneezing, depressed sick feeling, intense eye irritation and temporary disability. Under tropic conditions, it will irritate exposed skin. A protective mask gives adequate protection against CN-DM smokes and vapors.

2-25. Screening Smokes

A screening smoke is produced by dispersion of particles in the atmosphere through burning of solids or spraying of liquids. Such a smoke is used to obscure military movements, blanket the enemy from observation, spot artillery fire and bombing and to disguise cloud gas.

NOTE

Materials producing smoke screens are rated in units for their top obscuring power (TOP). TOP is a relative value that indicates the amount of obscurity (due to reflection and refraction of light rays) that 1 pound of smoke-producing material will develop under standard and controlled conditions against a 25-candlepower light source.

The principal smoke-producing agents, ordered according to their obscuring powers, are treated below:

a. White phosphorus (WP), with a 3,500 unit TOP, is a white to light yellow, waxlike, luminous substance (phosphorescent in the dark). On ignition, it produces a yellow-white flame and dense white smoke. WP is poisonous when taken internally; its smoke or fumes are not. When dispersed by ammunition, as small particles, WP ignites spontaneously on exposure to air. It continues to burn on contact with solid materials, even when embedded in human flesh. WP smoke is unpleasant to breathe but harmless. The particles, however, will poison food and water. WP is used in bursting-type projectiles, artillery and mortar rounds, grenades, rockets and bombs. It is used as an igniter in incendiary ammunition that contains flammable fuels (IM, NP, PT1). When used in projectiles that burst on terrain covered with soft deep snow, it is smothered and produces approximately 75 percent less smoke.

b. Plasticized white phosphorus (PWP) is a finely divided form of WP suspended in a thick-ended and gelled xylene rubber mixture. Like WP, it is an effective, double-purpose, screening and incendiary agent that can be dispersed under arctic and tropic conditions, and in temperate zones.

c. Sulfur trioxide-chlorosulfonic acid (FS), with a 2,240 unit TOP, is a liquid with an acrid and acid odor. It produces dense white smoke when dispersed in a humid atmosphere. FS smoke is nonpoisonous; however, its liquid irritates and inflames skin tissue on contact. A protective mask is required for protection against exposure to heavy concentrations. The mask and protective clothing should be used for protection against combination FS gas and liquid sprays. Liquid FS renders food and water unfit for use; the smoke merely imparts an unpleasant taste. Liquid FS possesses the corrosive properties of strong mineral acids, such as sulfuric or hydrochloric. Accordingly, during use and handling, stringent precautions should be observed for protecting nonaggressor personnel and noncombat forces and materiel. FS is dispersed from mortar rounds, grenades and by aircraft spray from cylinders. Under tropical and high humidity conditions, FS performs very effectively. FS is ineffective as smoke under conditions of low temperature and low humidity.

d. Hexachloroethane-zinc mixture (HC), with a 2,000 unit TOP, is a combination of zinc powder, hexachloroethane, ammonium perchlorate and ammonium chloride. When ignited, it produces zinc chloride that passes into the air as a dense grayish-white smoke. HC is toxic to unprotected personnel exposed to heavy concentrations for short periods or to light concentrations for extended periods of time. A protective mask offers adequate protection against light concentrations. For heavy concentrations and prolonged exposure, a self-contained oxygen mask is required. Food and water are not spoiled by HC, but acquire a disagreeable odor. HC in canisters, dispersed by base-ejection artillery projectiles, is not effective for use on terrain covered with deep loose snow. Under these conditions, canisters bury themselves and become smothered. However, they can be employed effectively on hard packed snow or ice. HC is dispersed effectively from fixed and floating smoke pots, base-ejection artillery projectiles, mortar projectiles and grenades under favorable (humid atmosphere and hard terrain) arctic or tropic conditions, or in temperate zones.

2-26. Incendiaries

Incendiaries are agents that can be used under field conditions to set fire to buildings, industrial installations, ammunition and fuel dumps, and so forth. Modern military incendiaries may be divided into three categories-oil, metal, and a combination of oil and metal. Incendiaries may also be classified as those which owe their effect to a self-supporting, heat-generating reaction and those which, for their combustion, depend upon oxygen in the surrounding atmosphere.

a. Thermite (TH) is an intimate, uniform mixture of approximately 27 percent powdered aluminum and 73 percent iron oxide. On ignition, it produces intense heat (approximately 4,300°F.) in a few seconds, with the formation of a white hot mass of molten iron and slag. TH is used in cartridges, bombs, grenades and mortar and artillery projectiles. TH-1 as a filler is included in thin-walled nonmagnesium metal containers.

b. Thermate (TH-3 and TH-4) is essentially a thermite, barium nitrate, sulfur and binder contained in a heavy-wall body, usually magnesium or a magnesium alloy. When initiated by electrical or mechanical means, the contents and body burn with an intense heat of about +3,700°F. Thermate fires are difficult to extinguish.

c. Magnesium, in fine powder, thin ribbon or solid form, is a material that ignites and burns with intense heat (3,630°F.) and white light. It is used extensively in pyrotechnic mixtures and incendiary munitions.

d. Incendiary oil (IM), such as an 88 percent gasoline mixture thickened with fatty soaps, fatty acids and such special chemical additives as isobutyl methacrylate polymer and naphthenic acid, is a typical example of a thickened fuel. It may or may not contain metallic sodium or WP particles for ignition. In addition, small amounts of a peptizer, such as cresylic acid, are added to aid in cold weather dispersion. When dispersed and ignited, IM adheres to both combustible and noncombustible surfaces. It burns like ordinary gasoline with a hot orange flame and gives off a black smoke. IM is used as a filler in bombs, grenades and portable and mechanized flame-throwers. Winterized IM incendiary fuels can be dispersed from bombs or grenades and is effectively employed under arctic conditions.

e. Incendiary oil, napalm (NP), is a flammable fuel, principally aviation gasoline (approximately 88 percent), thickened with a special gelling mixture of fatty acids, fatty soaps and antiagglomerate additives. As a filler, with or without metallic sodium or WP particles, NP can be used in munitions in the same manner as IM.

f. Incendiary mixtures (PT1 and PTV) are complex mixtures of gasoline, magnesium, thickening agents and conditioning agents. The same type of incendiary effect is obtained with PT1 and PTV as with oil incendiaries.

2-27. Flame-thrower Fuels

Flame-thrower fuels are either unthickened or thickened gasoline and oil mixes. When dispersed and simultaneously ignited by mechanical, electrical or chemical means, they cause destruction of materiel and casualties by burning or scorching with hot flame. The main flame-thrower fuels are as follows:

a. Unthickened fuels consisting of gasoline blended with light fuel oils or lubricating oils. Ingredient proportions are determined by the tactical situation and type of climate in which the flame-thrower is to be used. Unthickened fuel is used only in portable flame-throwers. It may be used when thickened fuel is not available or may be used in jungle operations.

b. Thickened fuels consisting of a fuel, mainly gasoline, gelled with aluminum soap thickeners or rubber-type thickeners. Thickened fuel increases the range of flame-throwers, imparts slower burning properties, gives clinging qualities, and causes flames to rebound off walls and go around corners.

2-28. Miscellaneous

a. Simulated Mustard Agents.

(1) Molasses residuum (MR) is a nontoxic (25 percent solution) of a thick, syrupy, viscous liquid with a molasses odor. It is used as a simulant for mustard (H or HD) agent.

(2) Asbestine suspension (AS) is a nontoxic suspension of finely ground asbestos in water. It may or may not include butyric acid, a material that imparts a disagreeable lingering scent like rancid butter. With butyric acid, AS is known as an asbestine-butyric acid suspension; without butyric, it is known as an asbestine suspension. AS is dispersed as a spray from aircraft. When dispersed, it will adhere like MR to surfaces and personnel and show up in contrast to the surrounding medium.

b. *Chlorine*. Chlorine, a choking agent, was the first chemical agent to be dispersed on a major scale in wartime. It was released by the Germans against the British during World War I. Chlorine is no longer used as a war gas, having been succeeded by phosgene and diphosgene. However, it is still used for training purposes.

2-29. Marking and Identification

a. All ammunition containing chemical agents is identified and marked with distinctive symbols or letters and colors, as indicated in chapter 1.

b. For the purpose of storage, chemical agents and munitions are segregated into four groups, according to the nature of the filling and their inherent hazards as follows:

(1) *Group A*- (blister and nerve gases)-includes chemical agents requiring complete protective clothing plus protective masks.

(2) *Group B* - (toxic and smoke)-includes chemical agents requiring protective masks.

(3) *Group C* - includes spontaneously flammable chemical agents, such as WP.

(4) *Group D* - includes incendiary and readily flammable chemical agents.

CHAPTER 3

SMALL-ARMS AMMUNITION

3-1. General

Small-caliber ammunition, as used herein, describes a cartridge or families of cartridges intended for use in various types of hand-held or mounted weapons through 30 millimeter. Within a caliber designation, these weapons may include one or more of the following: rifles (except recoilless), carbines, pistols, revolvers, machineguns and shotguns. For purposes of this publication, smallarms ammunition may be grouped as cartridges intended primarily for combat or training purposes (API, HEI, tracer or ball); for training purposes only (blank or dummy); or for special purposes (rifle grenade or spotter-tracer). Refer to TM 9-1305-201-20&P, TM 9-1305-201-34&P, and TM 43-0001-27 for more detailed information on small arms ammunition.

3-2. Cartridges

In general, a small-arms cartridge is identified as an assembly of a cartridge case, primer, a quantity of propellant within the cartridge case, and a bullet or projectile. Blank and rifle grenade cartridges are sealed with paper closure disks in lieu of bullets. Dummy cartridges are composed of a cartridge case and a bullet. Some dummy cartridges contain insert granular materials to simulate the weight and balance of live cartridges. A typical cartridge and the terminology of its components are shown in figure 8-1.

a. Case. Although steel, aluminum, zinc and plastic materials have been used experimentally, brass, a composition of 70 percent copper and 80

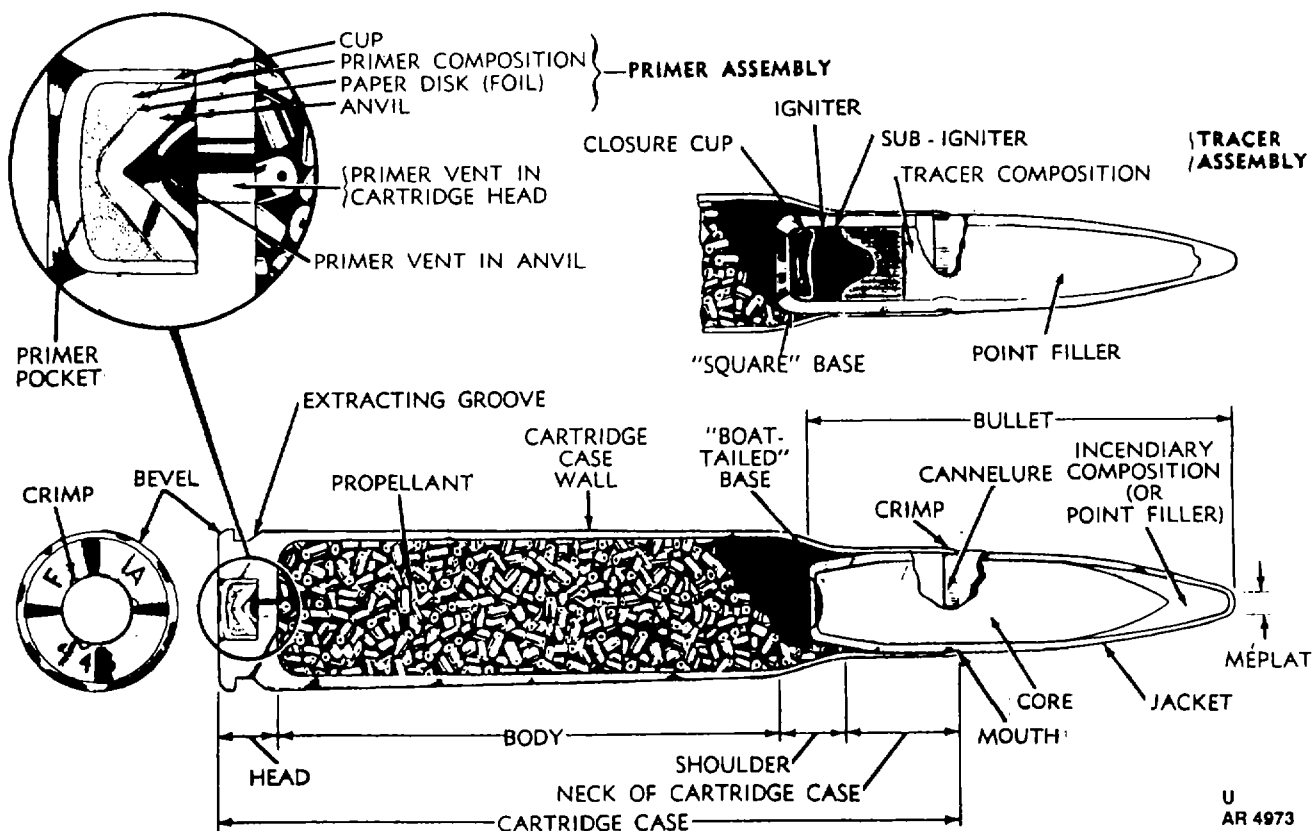

Figure 3-1. Typical cartridge (sectioned).

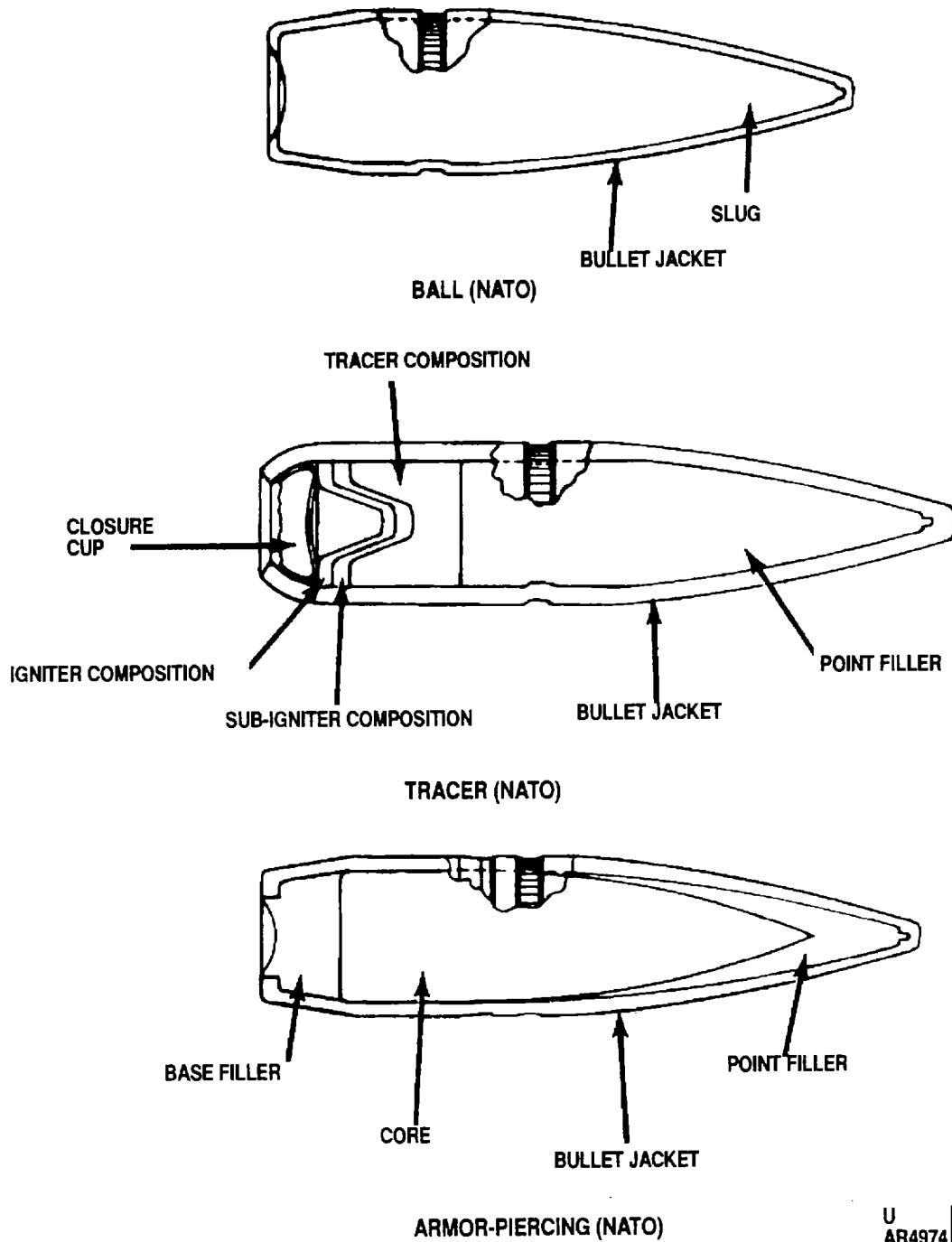
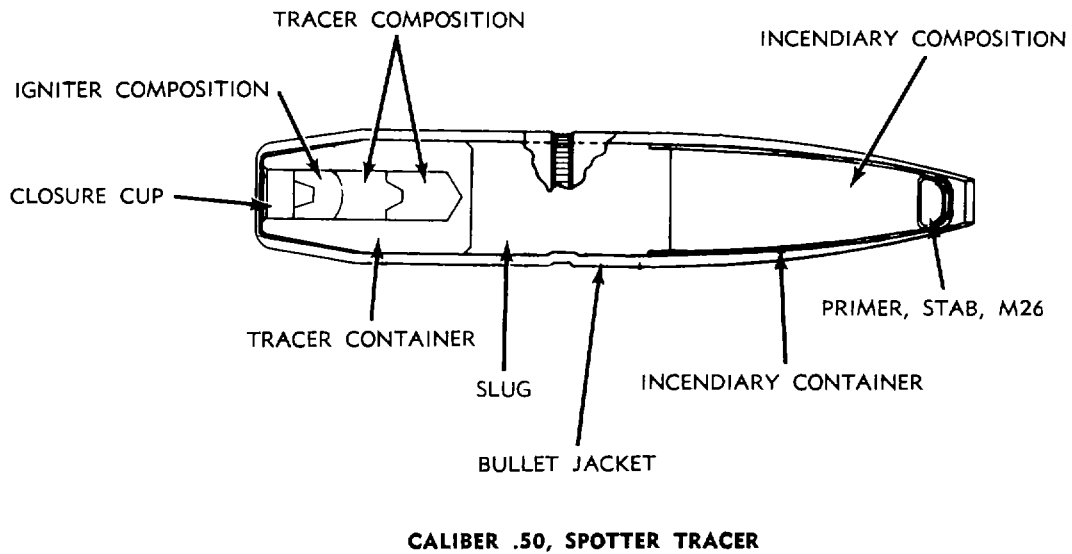
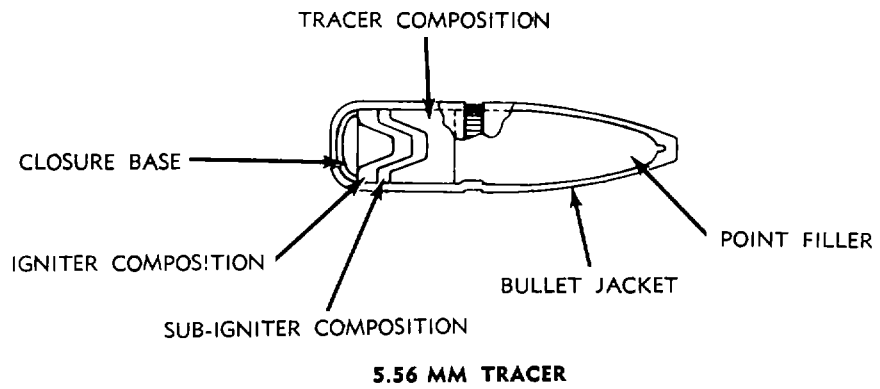
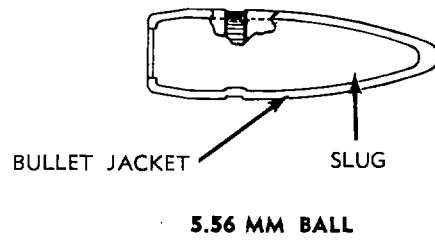

Figure 3-2. 7.62 MM bullets (sectioned)

Change 5 3-2

U
AR4974



MU-D 2234

Figure 3-3. 5.56MM and caliber .50 spotter tracer bullets (sectioned).

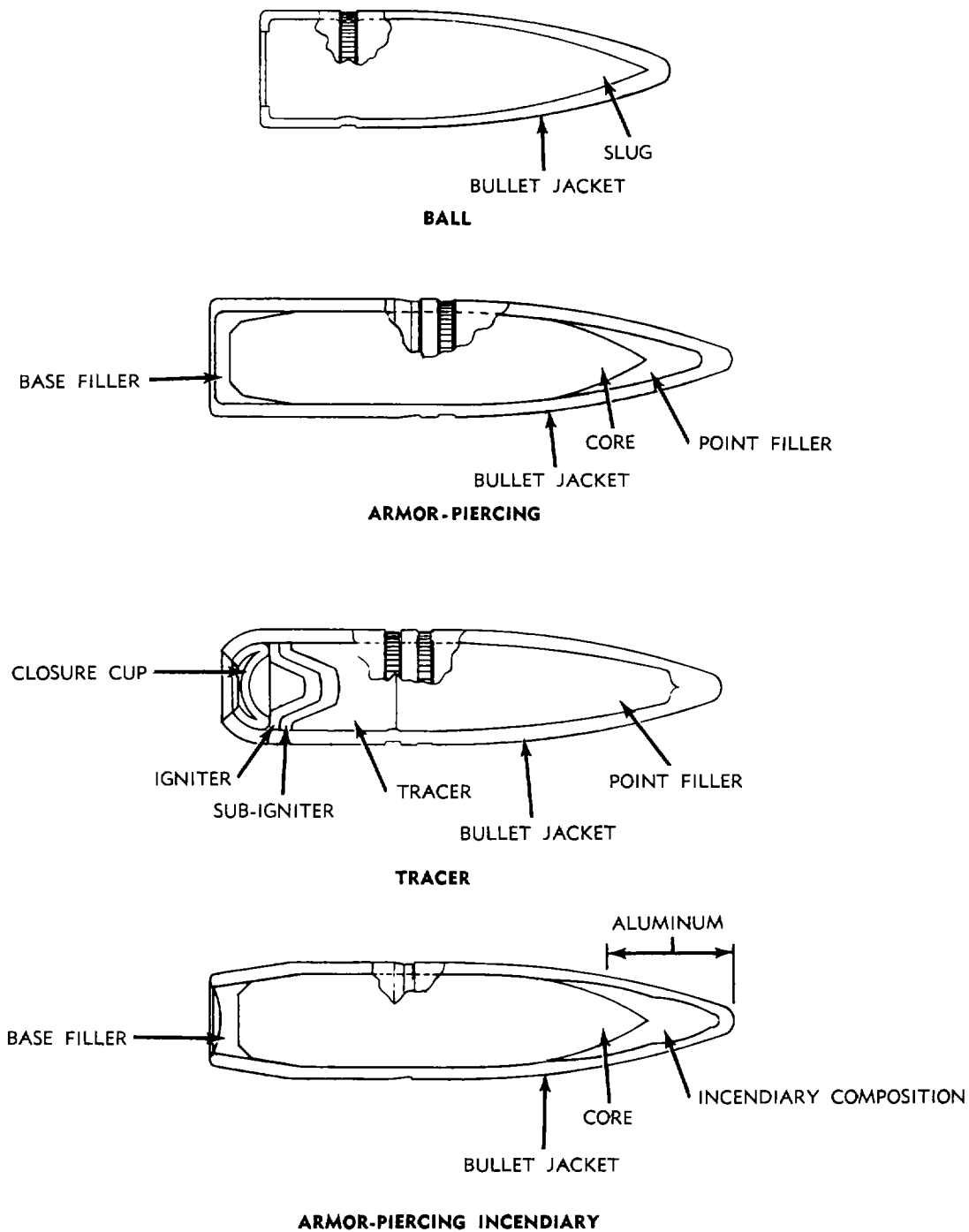
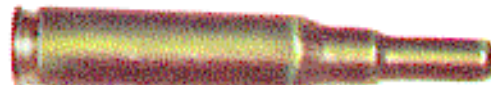

Figure 3-4. Caliber .30 bullets (sectioned).

MU-D 2235



BALL



BLANK



HIGH-PRESSURE TEST (HPT)



MATCH



ARMOR-PIERCING (AP)

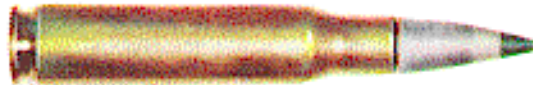

BALL, FRANGIBLE



TRACER

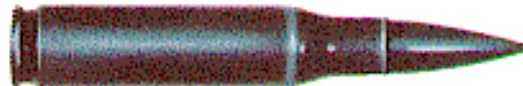

DUMMY, INERT-LOADED



DUMMY

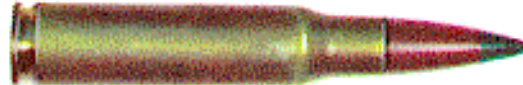

DUPLEX

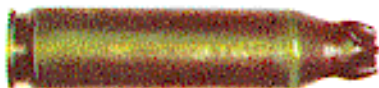

RIFLE GRENADE

WU-D 223a

Figure 3-5. 7.62MM cartridges.

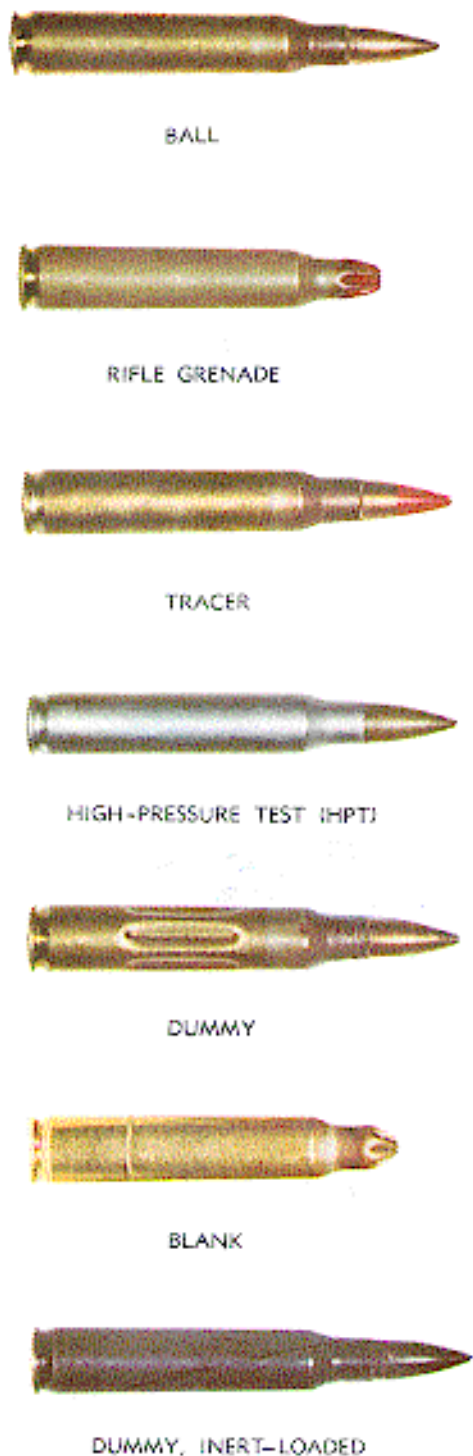

MU-D 2237

Figure 3-6. 5.56MM cartridges.

percent zinc, is the most commonly used material for cartridge cases. Steel, as well as brass, is an approved material for caliber .45 cartridge cases. Brass, paper and plastic are used for 12 gage shotshell bodies and aluminum is used for military-type .410 gage shotshell bodies. Configurations of cartridges and bullets are illustrated in figures 3-2 through 3-11.

b. Propellant. Cartridges are loaded with varying weights of propellant. This is to impart sufficient velocity (within safe pressures) to the projectile to obtain the required ballistic performance. These propellants are either of the single base (nitrocellulose) or double-base (nitrocellulose and nitroglycerin) type. The propellant grain configuration may be cylindrical with a single, lengthwise perforation, spheroid (ball) or flake. Most propellants are coated with a deterrent (to assist in controlling the rate of combustion) and with a final coating of graphite (to facilitate flow of propellant and eliminate static electricity in loading cartridges).

c. Primer. Small-arms cartridges contain either a percussion or electric primer. The percussion primer consists of a brass or gilding metal cup that contains a pellet of sensitive explosive material secured by a paper disk and a brass anvil. The electric primer consists of an electrode button in contact with the priming composition, a primer cup assembly and insulators. A blow from the firing pin of the weapon on the center of the percussion primer cup base compresses the primer composition between the cup and the anvil. This causes the composition to explode. The function of the electric primer is accomplished by a firing pin with electrical potential, which contacts the electrode button. This allows current to flow through the energy-sensitive priming composition to the grounded primer cup and cartridge case, exploding the priming composition. Holes or vents in the anvil or closure cup allow the flame to pass through the primer vent in the cartridge case and ignite the propellant. Rimfire ammunition, such as the caliber .22 cartridge, does not contain a primer assembly. Instead, the primer composition is spun into the rim of the cartridge case and the propellant is in intimate contact with the composition. On firing, the firing pin strikes the rim of the cartridge case, compressing the primer composition and initiating its explosion.

d. Bullet. With few exceptions, bullets through caliber .50 are assemblies of a jacket and a lead or steel core. They may contain other components or

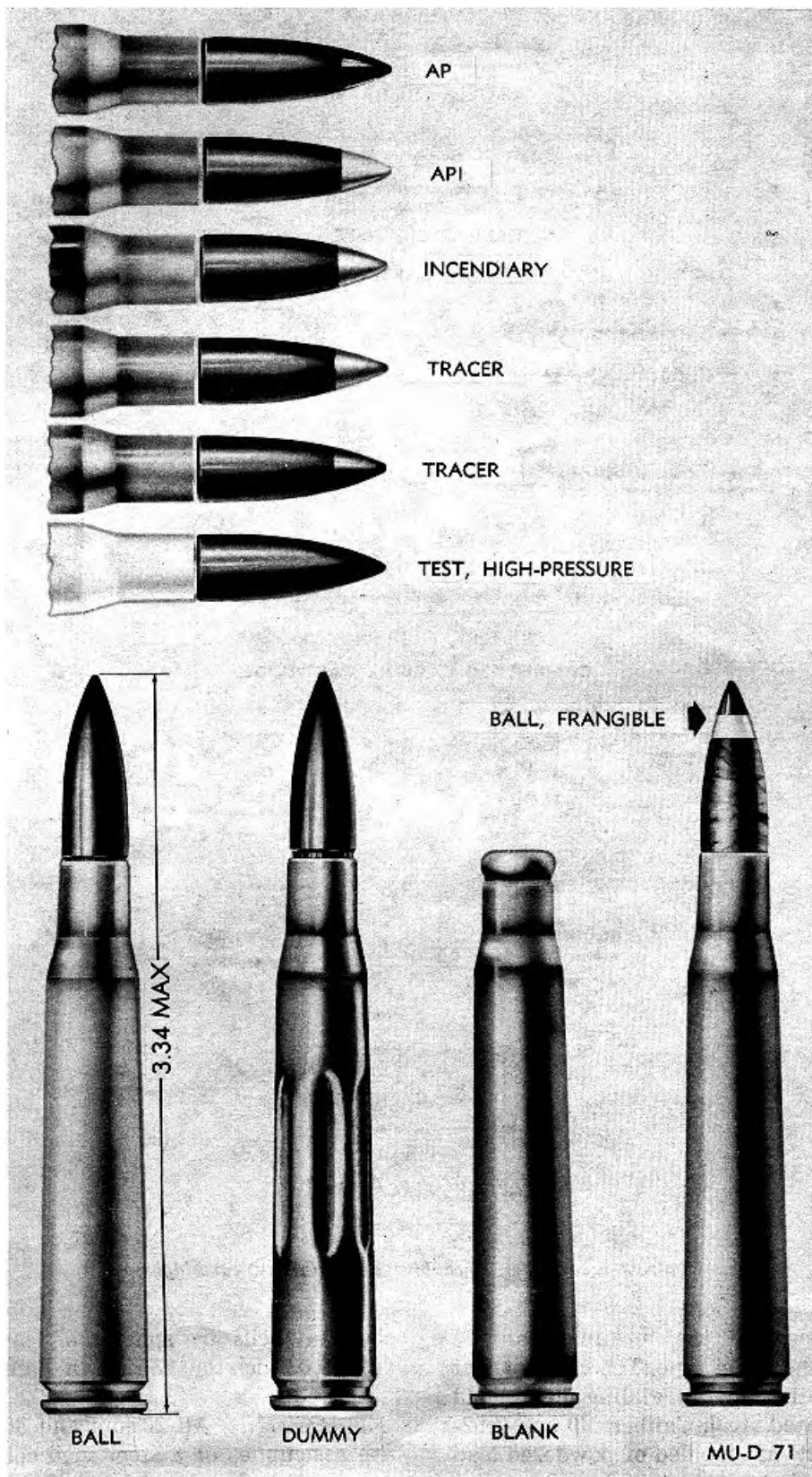

Figure 3-7. Caliber .30 cartridges.

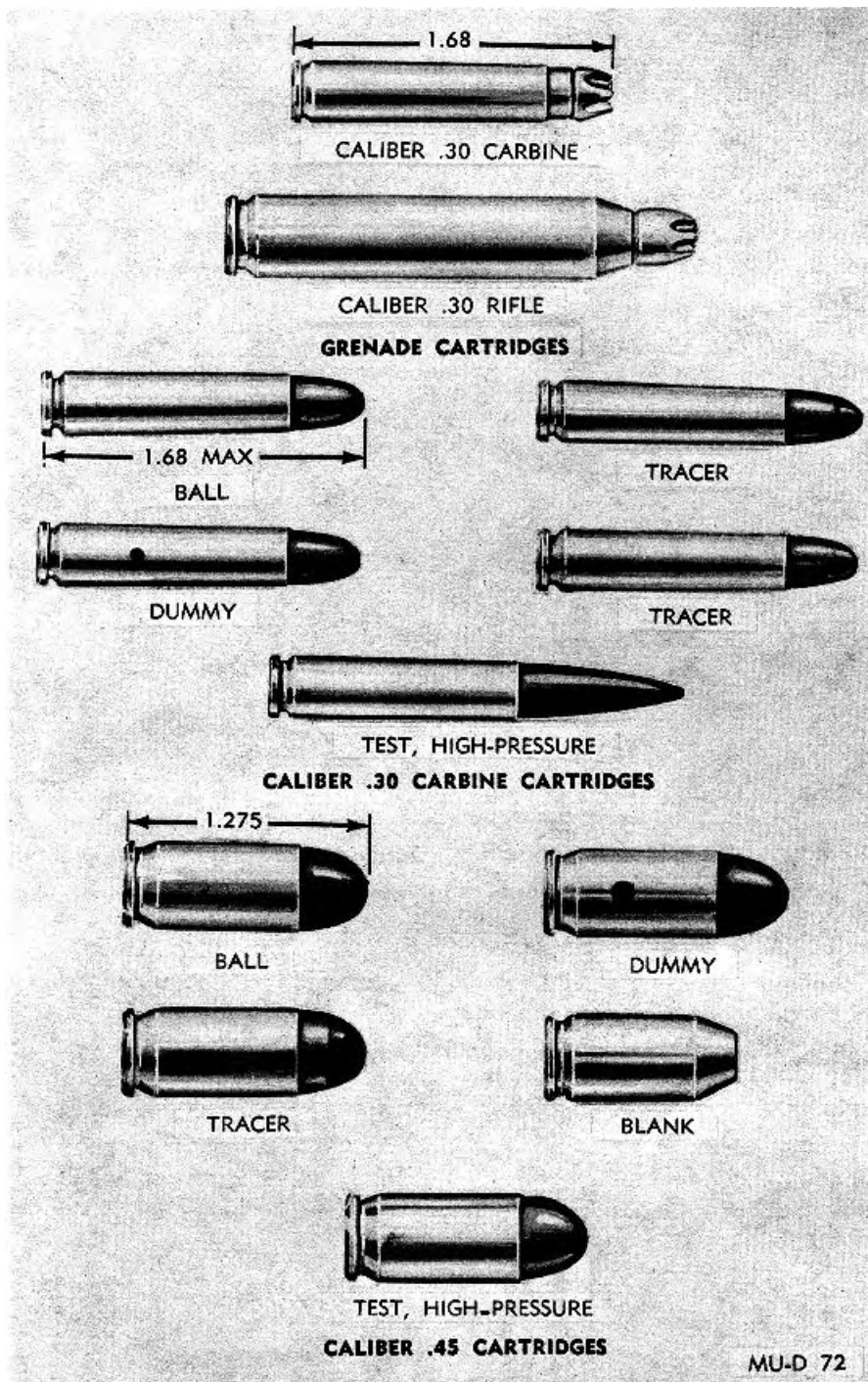

Figure 3-8. Caliber .30 carbine and caliber .45 cartridges.

chemicals which provide the terminal ballistic characteristics of the bullet type. The bullet jacket may be either gilding metal, gilding-metal clad steel, or copper plated steel. Caliber .30 and 7.62mm frangible bullets are molded of powdered lead and a friable plastic which pulverizes into dust upon impact with the target.

The pellets used in shotgun shells are spheres of lead alloys varying from 0.08 inch to 0.33 inch in diameter.

e. *Projectile.* All 20-mm and 30-mm projectiles are assemblies of a steel shell containing a brass rotating band and a point-detonating nose fuze or an aluminum, steel or plastic nose plug.

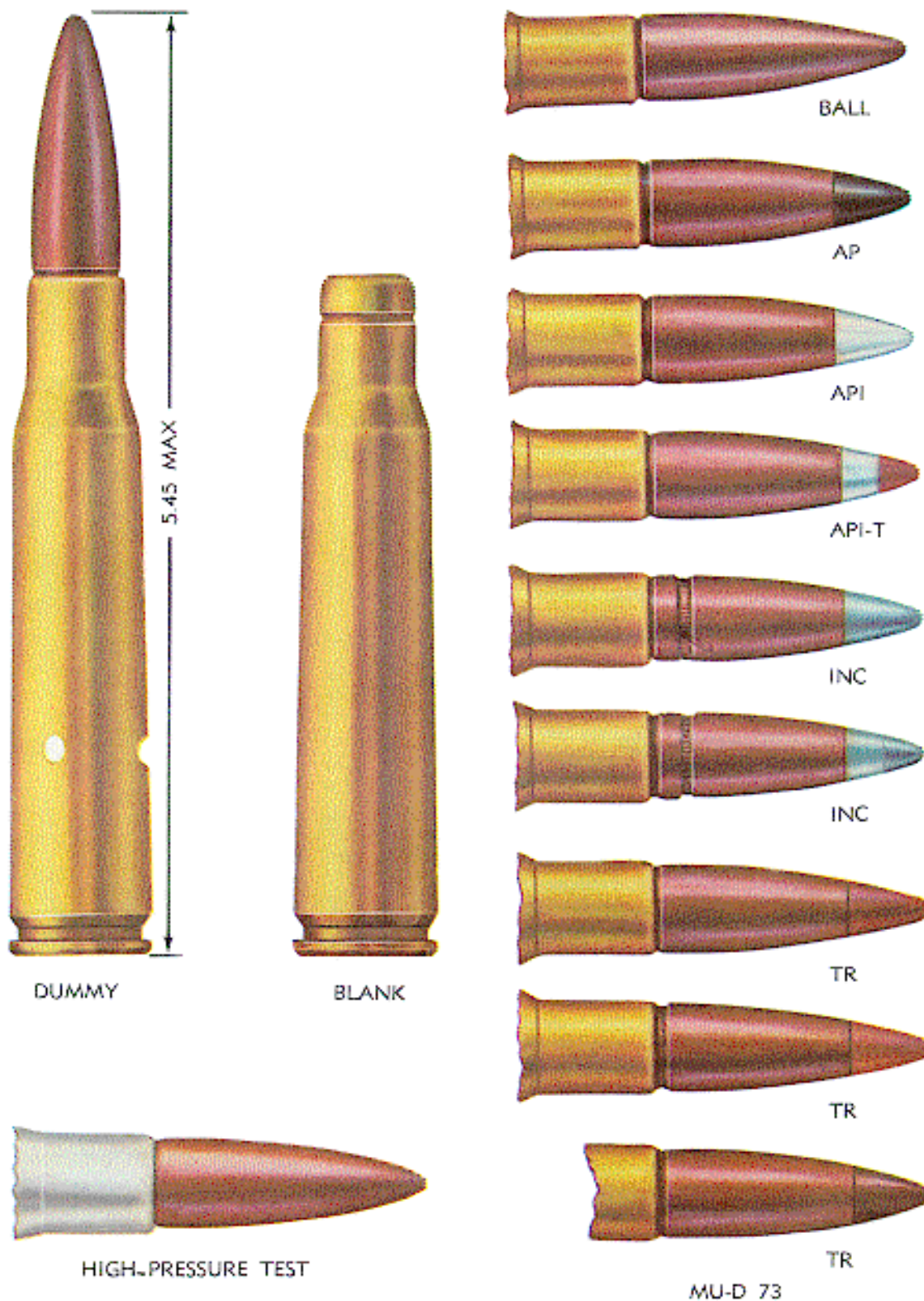

Figure 3-9. Caliber .50 cartridges.

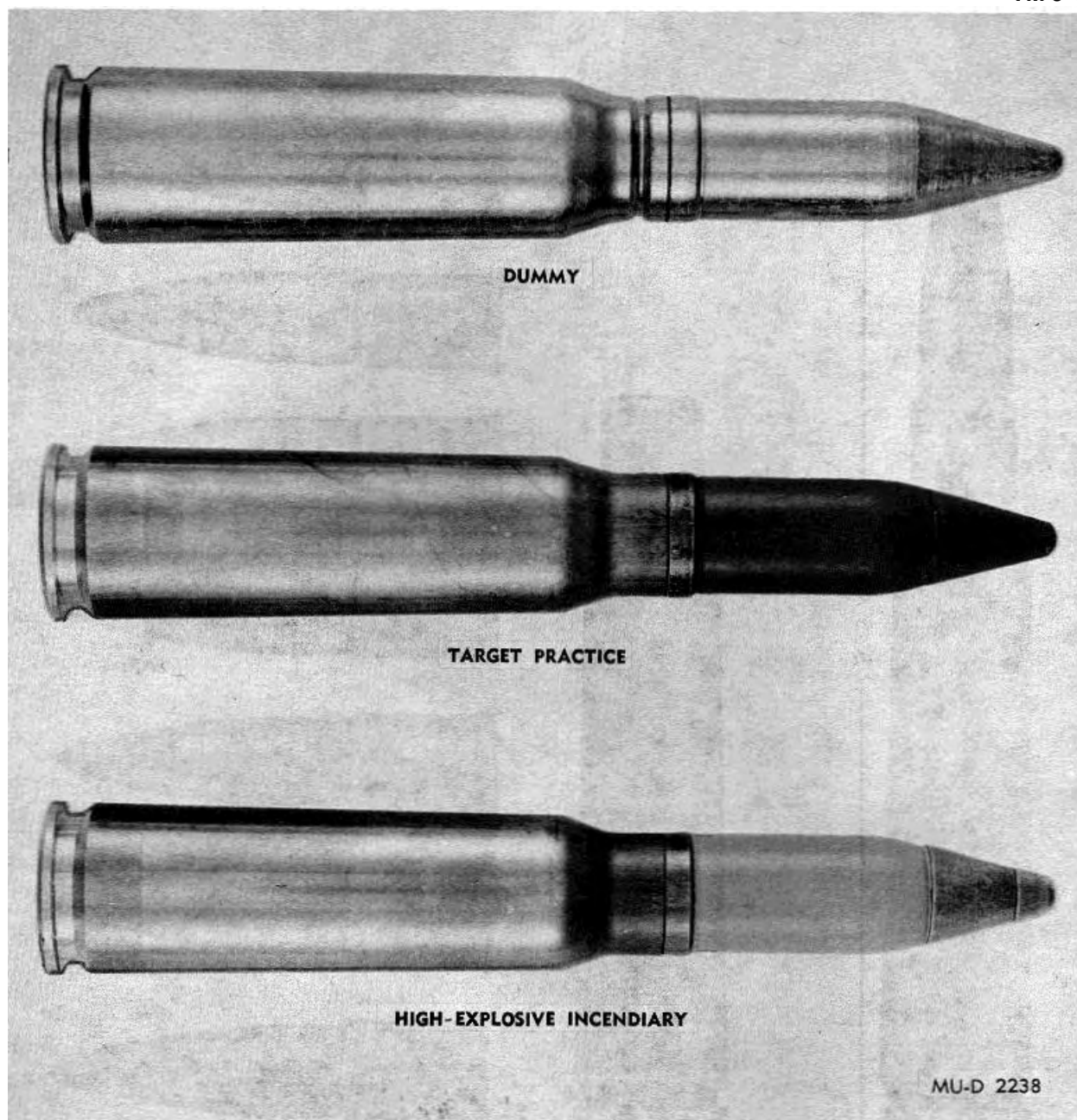

Figure 3-10. 20mm cartridges.

3-3. Ball Cartridge

The ball cartridge is intended for use in rifles, carbines, pistols, revolvers and/or machineguns against personnel and unarmored targets. The bullet, as designed for general purpose combat and training requirements, normally consists of a metal jacket and a lead slug. Caliber .50 ball bullet and 7.62-mm, Ball M59 bullet contain soft steel cores.

3-4. Tracer Cartridge

By means of a trail of flame and smoke, the tracer cartridge is intended to permit visible observation of the

bullet's in-flight path or trajectory and the point of impact. It is used primarily to observe the line of fire. It may also be used to pinpoint enemy targets to ignite flammable materials and for signaling purposes. The tracer element consists of a compressed, flammable, pyrotechnic composition in the base of the bullet. This composition is ignited by the propellant when the cartridge is fired. In flight, the bullet emits a bright flame which is visible to the gunner. Trace burnout occurs at a range between 400 and 1,600 yards, depending upon the caliber of ammunition.

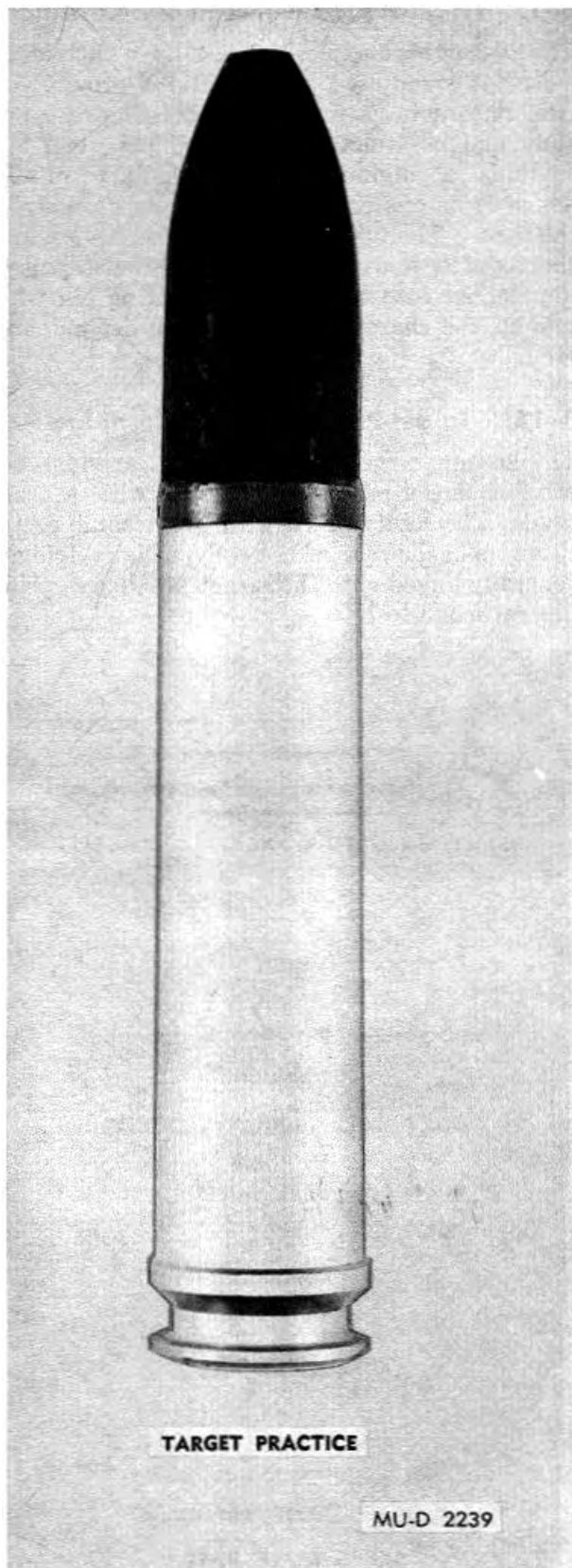

Figure 3-11. Typical 30mm cartridge.

3-5. Match Cartridge

The match cartridge is used in National and International Match Shooting competitions. The bullet consists of a gilding-metal jacket over a lead slug. The cartridges are identified on the head face with the designation NM (National Match) or Match.

3-6. Armor-Piercing Cartridges

The armor-piercing cartridge is intended for use in machineguns or rifles against personnel and light armored and unarmored targets, concrete shelters, and similar bullet-resisting targets. The bullet consists of a metal jacket and a hardened steel-alloy core. In addition, it may have a base filler and/or a point filler of lead.

3-7. Armor-Piercing-Incendiary Cartridge

The armor-piercing-incendiary cartridge is used in rifles or machineguns as a single combination cartridge in lieu of separate armor-piercing and incendiary cartridges. The bullet is similar to the armor-piercing bullet, except that the point filler is incendiary mixture instead of lead. Upon impact with the target, the incendiary mixture bursts into flame and ignites flammable material.

3-8. Armor-Piercing-Incendiary Tracer Cartridge

The bullet of the armor-piercing-incendiary-tracer cartridge combines the features of the armor-piercing, incendiary, and tracer bullets and may be used to replace those cartridges. The bullet consists of a hard steel core with compressed pyrotechnic mixture in the cavity in the base of the core. The core is covered by a gilding-metal jacket with incendiary mixture between the core point and jacket. This cartridge is for use in caliber .50 weapons only.

3-9. Duplex Cartridge

The duplex cartridge contains two special ball-type bullets in tandem. The front bullet is positioned partially in the case neck, similarly to a standard ball bullet. The rear bullet, positioned completely within the case, is held in position by a compressed propellant charge. The base of the rear bullet is angled so that in flight, it follows a path slightly dispersed from that of the front bullet.

3-10. Spotter-Tracer Cartridge

The spotter-tracer cartridge is intended for use in coaxially mounted caliber .50 spotting rifles. The bullet trajectory closely approximates that of 106-mm projectiles. Thus, this cartridge serves as a fire control device to verify weapon sight settings before firing 106-mm weapons. The bullet contains an impact detonator and incendiary composition which identify the point of impact by flash and smoke.

3-11. Blank Cartridge

The blank cartridge is distinguished by absence of a bullet. It is used for simulated fire, in training maneuvers, and for saluting purposes. It is fired in rifles and machineguns equipped with blank firing attachments.

3-12. Grenade Cartridge

The grenade cartridge is used to propel rifle grenades and ground signals from launchers attached to rifles or carbines. All rifle grenade cartridges are distinguished by the rose petal (rosette crimp) closure of the case mouth. For information pertaining to grenades, see chapter 6.

3-13. Frangible Cartridge

The caliber .30 frangible cartridge, designed for aerial target training purposes, is also used in rifles and machineguns for target shooting. Caliber .30 and 7.62MM frangible cartridges are used in tank machineguns, firing single shot, for training in tank gunnery. At its normal velocity, the bullet, which is composed of powdered lead and friable plastic, will completely disintegrate upon striking a 3/16-inch aluminum alloy plate at 100 yards from the muzzle of the gun. These cartridges are not to be used on any but well ventilated indoor ranges to preclude buildup of toxic bullet dust. Inhalation of bullet dust may be injurious to health.

3-14. Incendiary Cartridge

The incendiary cartridge was designed for aircraft and ground weapon use to ignite combustible targets (e.g., vehicular and aircraft fuel tanks). The bullet contains a compressed incendiary mixture which ignites upon impact with the target. The incendiary cartridge has been superseded by the API and APIT cartridges because of their improved terminal ballistic effects.

3-15. High-Explosive-Incendiary Cartridge

The 20-mm high-explosive-incendiary cartridge is a combat round used on aircraft and ground vehicles. It contains a projectile consisting of a steel body and point-detonating fuze. The steel body contains a high-explosive incendiary mixture which is detonated on impact as the fuze strikes the target. The fuze, a high-precision device, arms shortly after leaving the muzzle of the weapon. On impact, the fuze releases a small firing pin which sets off the charge in the fuze and detonates the HEI.

3-16. Target-Practice Tracer Cartridge

The 20-mm target-practice-tracer cartridge contains a target-practice projectile with a tracer cavity. The cavity, filled with pyrotechnic composition, is in the rear of the body. This cartridge is generally linked with the target-practice cartridge in a ratio of 1 to 7.

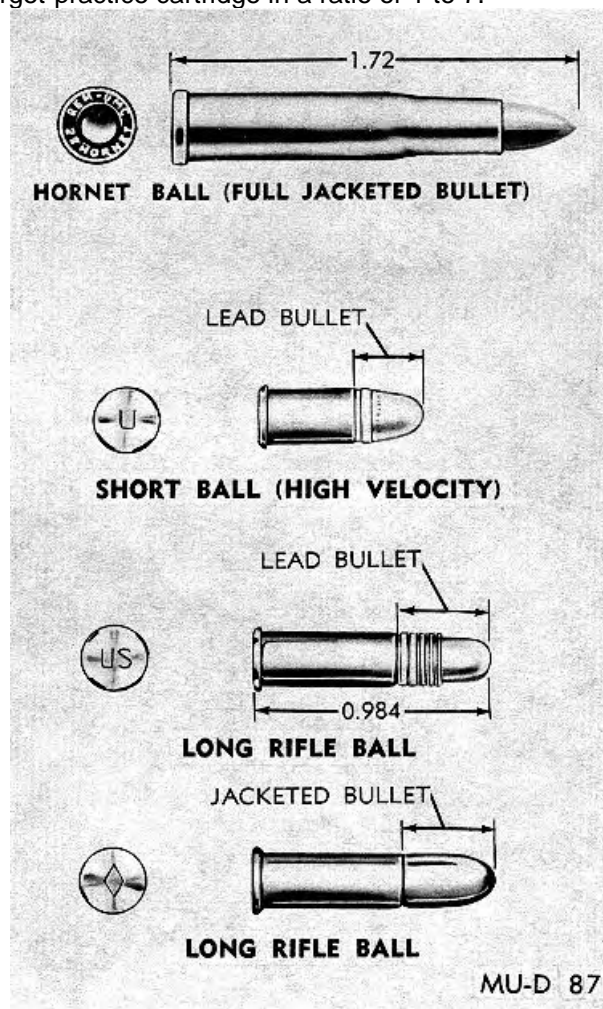

Figure 3-12. Caliber .22 cartridges.

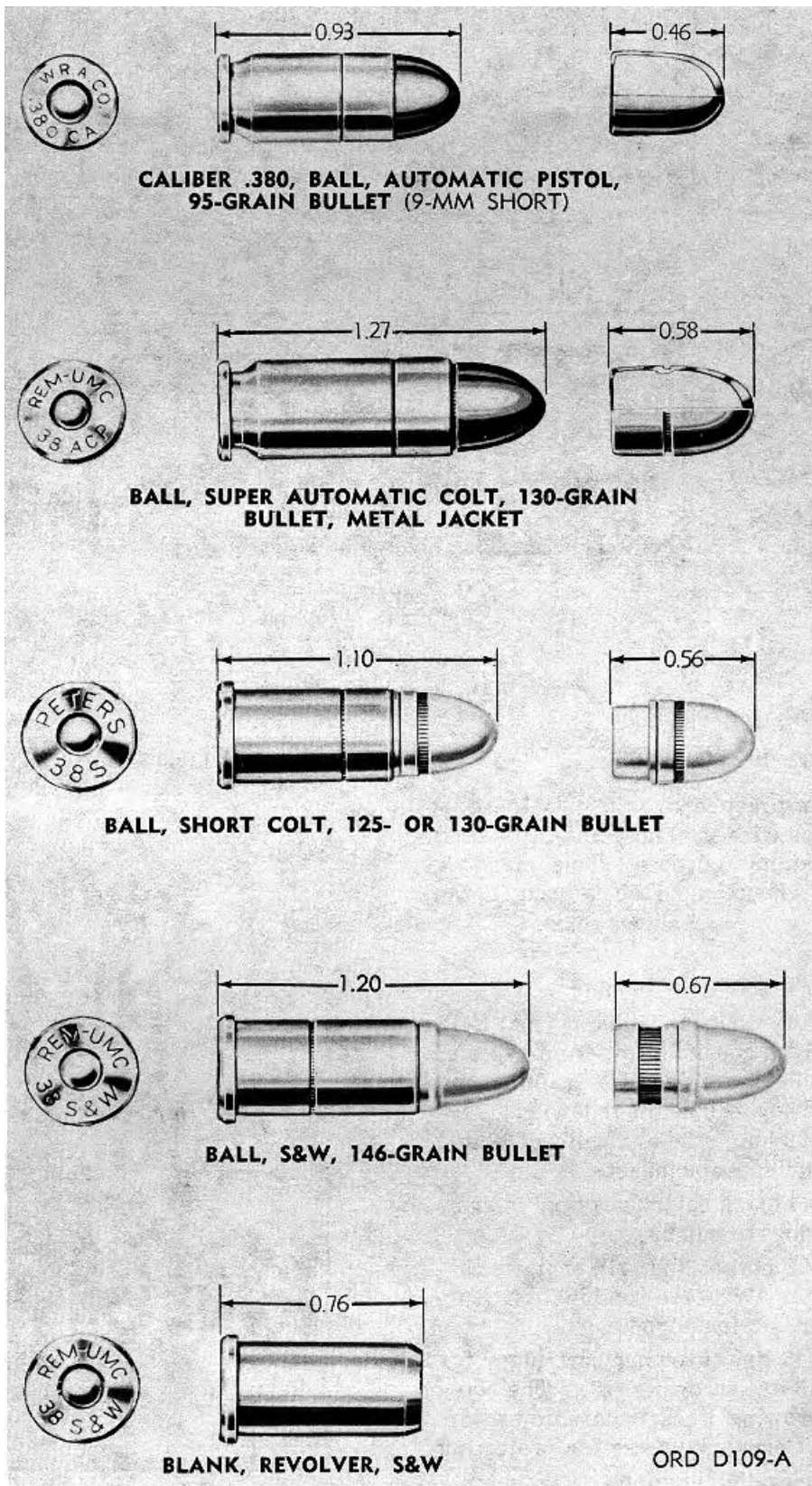

Figure 3-13. Caliber .38 cartridges.

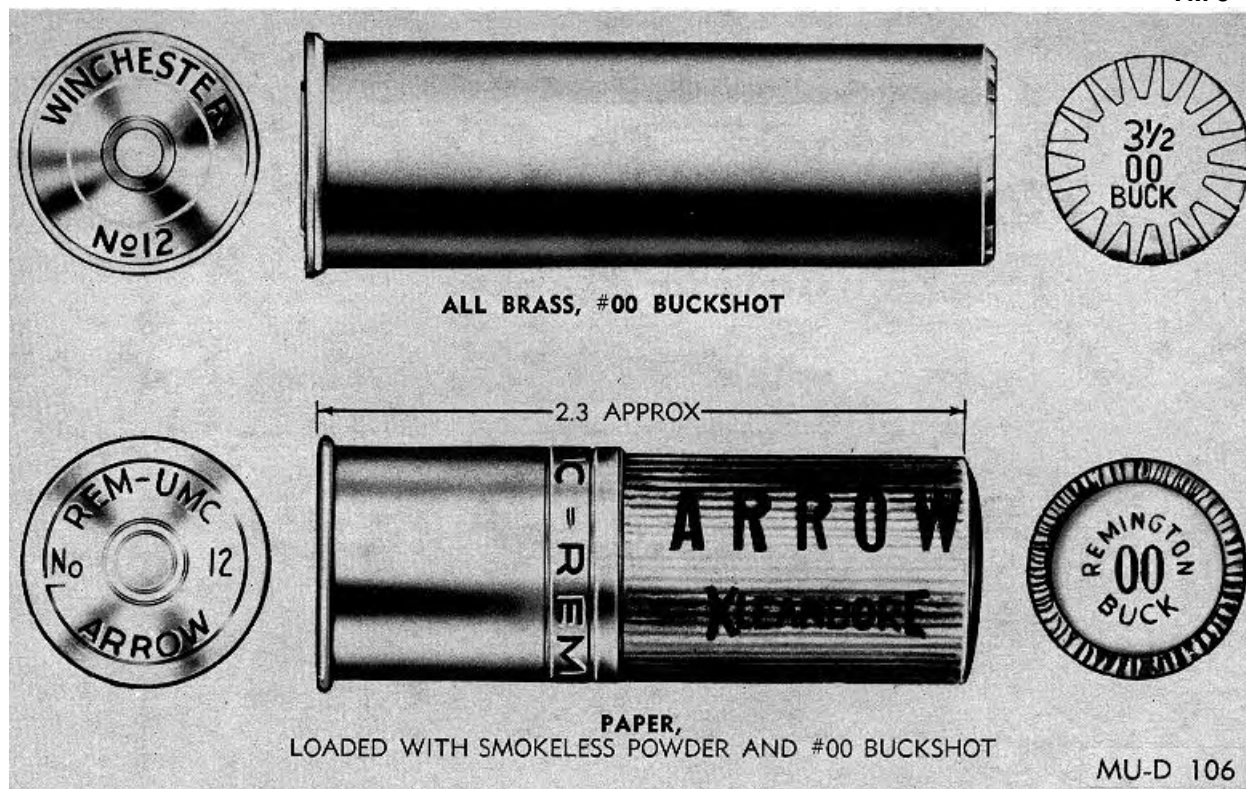

Figure 3-14. 12 gauge shotgun shells.

3-17. Target-Practice Cartridges

The 20-mm target-practice cartridge is the conventional steel shell with steel nose plug. It is used primarily for training purposes. This is not a combat cartridge; hence, no fuze is used in the assembly.

3-18. Special Purpose Cartridges

a. Cartridges of various calibers (fig. 3-12 through 3-14), which consist of different types of projectiles and bullets, are used for training and special purposes. They include the following:

- (1) Caliber .22 long rifle and caliber .38 and .45 wad-cutter cartridges for target shooting.
- (2) Caliber .45 blank cartridges fired in exercises to condition dogs to gun fire.
- (3) Caliber .22 hornet and .410 shotgun cartridges for firing in Air Force combination (survival) weapons for hunting purposes.
- (4) Caliber .45 line-throwing cartridges for firing in caliber .45 line-throwing rifles. The Navy uses these for throwing lines from ship-to-ship. The Army Signal Corps uses these for projecting signal wires over elevated terrain
- (5) Shotshells containing the designated shot sizes as required for the following:

- (a) 12 gauge #00 Buck for guard duty.
- (b) 12 gauge #4 Buck for guerrilla purposes.

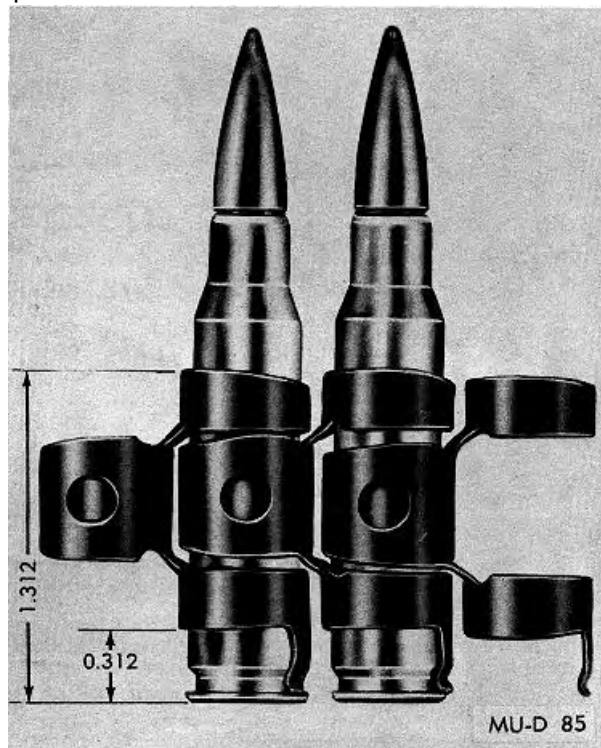

Figure 3-15. Linked 7.62-mm cartridges.

(c) 12 gage #6, 7 1/2 and 8 shot for clay target shooting for training purposes.

(d) .410 gage #7 shot for caliber .22/.410 survival weapons maintained in aircraft.

b. Special purpose cartridges also include the following types of military cartridges:

(1) *Dummy*. The dummy cartridge is used for practice in loading weapons and simulated firing to detect flinching of personnel when firing weapons. It consists of a cartridge case and a ball bullet. Cartridge identification is by means of holes through the side of the case or longitudinal corrugations in the case and by the empty primer pocket.

(2) *Dummy inert-loaded*. This cartridge consists of a cartridge case, a ball bullet and inert granular material in the case simulating the weight and balance of a live cartridge. The exterior of the cartridge is identified by a black chemical finish and by the absence of a primer. This cartridge is used by installations for testing weapon function, linkage and feed chutes.

(3) *High-pressure test*. High-pressure test ammunition is specially loaded to produce pressures substantially in excess of the maximum average or individual pressures of the corresponding service cartridge. This cartridge is not for field issue. It is used

only by armorers and weapons mechanics for proof firing of weapons (rifles, pistols, machine guns) at place of manufacture, test and repair. Because of excessive pressures developed by this type of ammunition, and the potential danger involved in firing, proofing of weapons is conducted only by authorized personnel from fixed and shielded rests by means of a lanyard or other remote control methods.

3-19. Metallic Links and Clips

a. Metallic links (fig. 3-15 and 3-16) are used with caliber .30, caliber .50, 5.56-mm, 7.62-mm and 20-mm cartridges in machine guns. The links are made of steel, surface treated for rust prevention. They are used to assemble cartridges into linked belts of 100 to 750 cartridges per belt. The links must meet specific test and dimension requirements to assure satisfactory ammunition feed and functioning in the machine gun under all training and combat service conditions.

b. Different configurations of cartridge clips permit unitized packages of ammunition. This facilitates transfer of cartridges to appropriate magazines for caliber .30, 7.62-mm and 5.56-mm -rifles. The caliber .30 eight-round clip feeds eight cartridges as a unit into the receiver of the rifle.

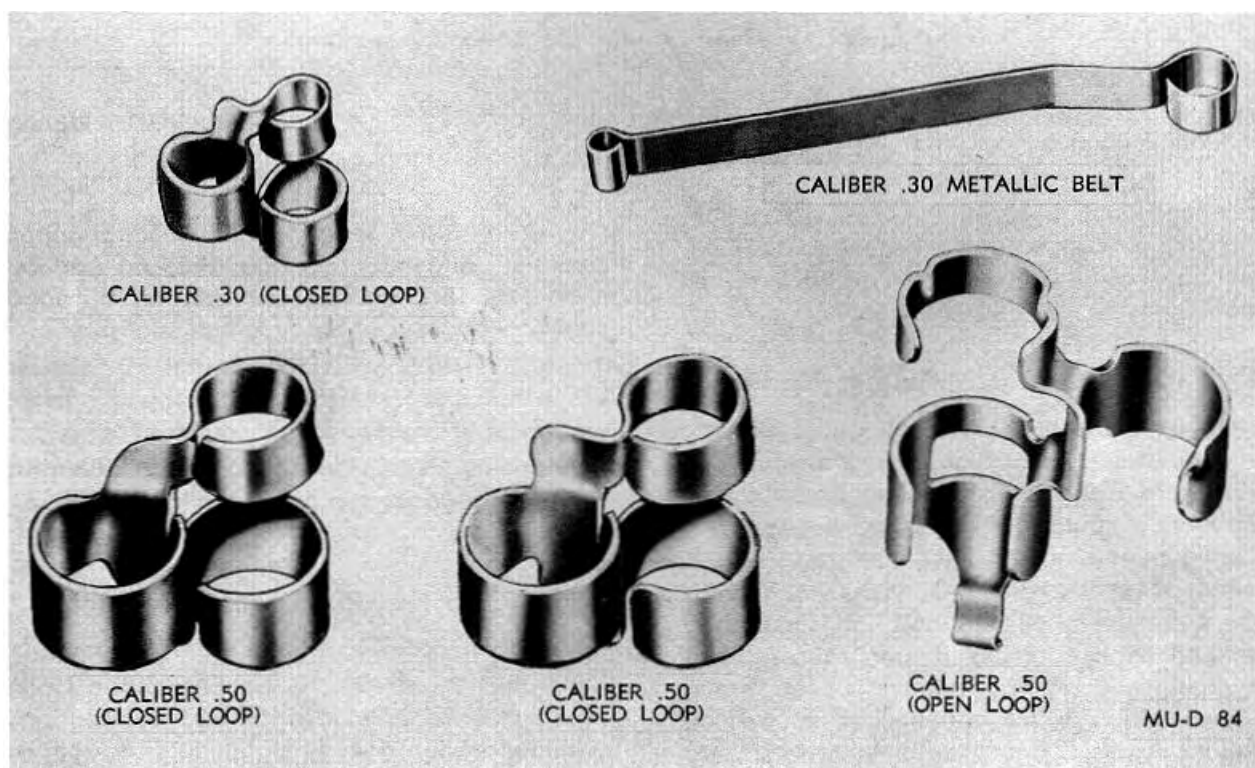

Figure 3-16. Links for caliber .30 and caliber .50 ammunition.

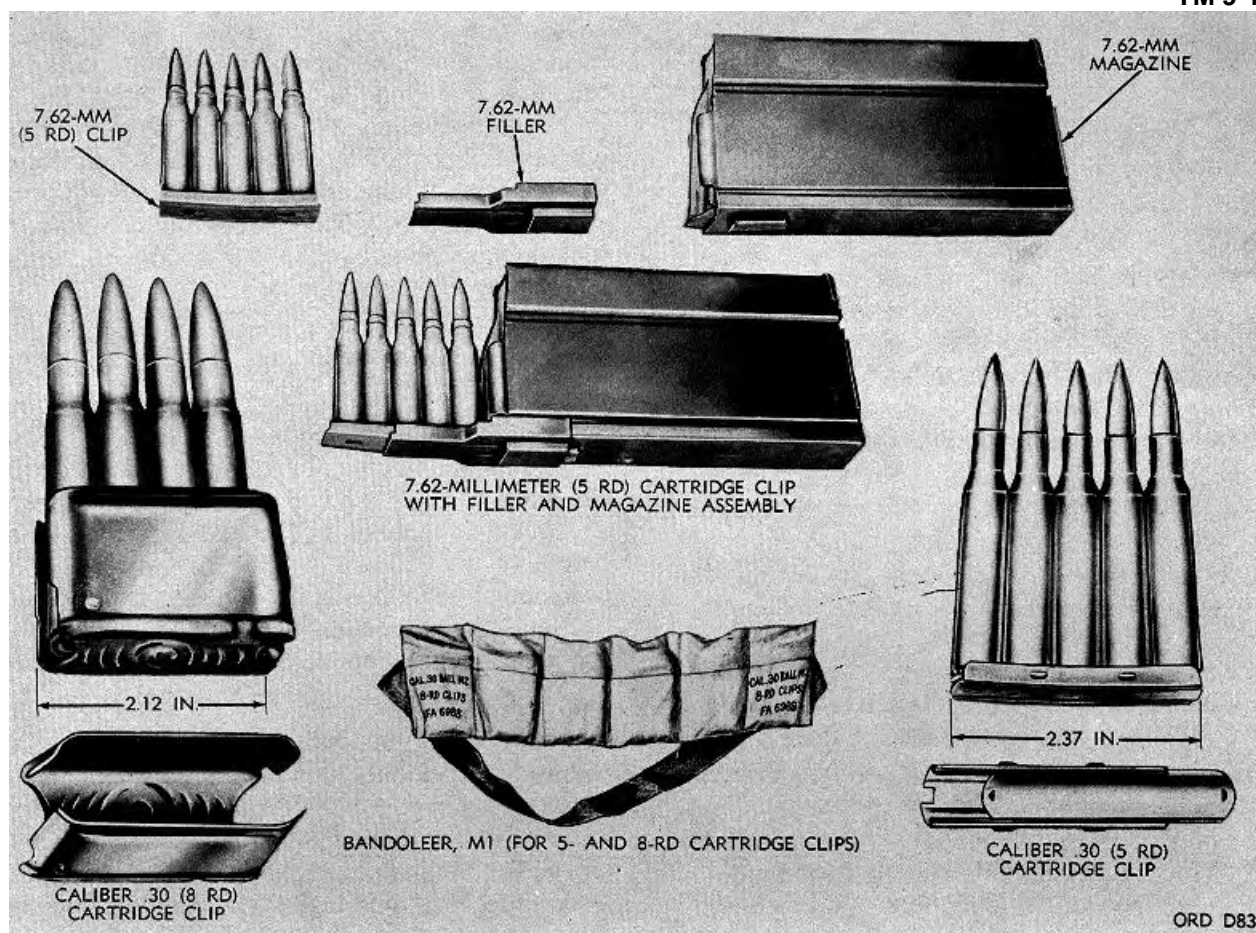

Figure 3-17. Bandoleer, magazines, filler and clips.

The caliber .45 clip feeds three cartridges as a unit into the revolver cylinder. Five-round and eight-round clips are used with caliber .30 cartridges; five-round clips with 7.62-mm cartridges; ten-round clips with caliber .30 carbine and 5.56mm cartridges; and three-round clips with caliber .45 cartridges.

3-20. Packing and Identification Marking

a. Packing. Containers and methods for packing military small-arms ammunition are specified in drawings, specifications or, as required, in the procurement contract. Military containers presently being manufactured have been limited to a few standard types designed to withstand all conditions commonly encountered in handling, storage and transportation of ammunition. Military cartridges, except 20-mm, are packed in metallic ammunition boxes, overpacked in wooden wire-bound crates. Twenty millimeter cartridges are packed in ammunition boxes only. When commercial cartridges are not packed in a military pack, they are packed in accordance with standard commercial practices. For detailed description of the variety of packings, refer to SC 1305/30-IL.

b. Identification Markings. Each outer shipping container and all inner containers are fully marked to identify the ammunition. Wirebound boxes are marked in black and ammunition boxes are painted olive drab, with markings in yellow. When linked ammunition is functionally packed, component lot numbers are replaced by a functional lot number. Typical packing and identification markings are illustrated in figures 3-17 through 3-20.

3-21. Care, Handling and Preservation

a. General. Small-arms ammunition is comparatively safe to handle. It is packed to withstand transportation, handling and storage conditions normally encountered in the field. However, consideration should be given to the general information on care, handling and preservation of ammu-

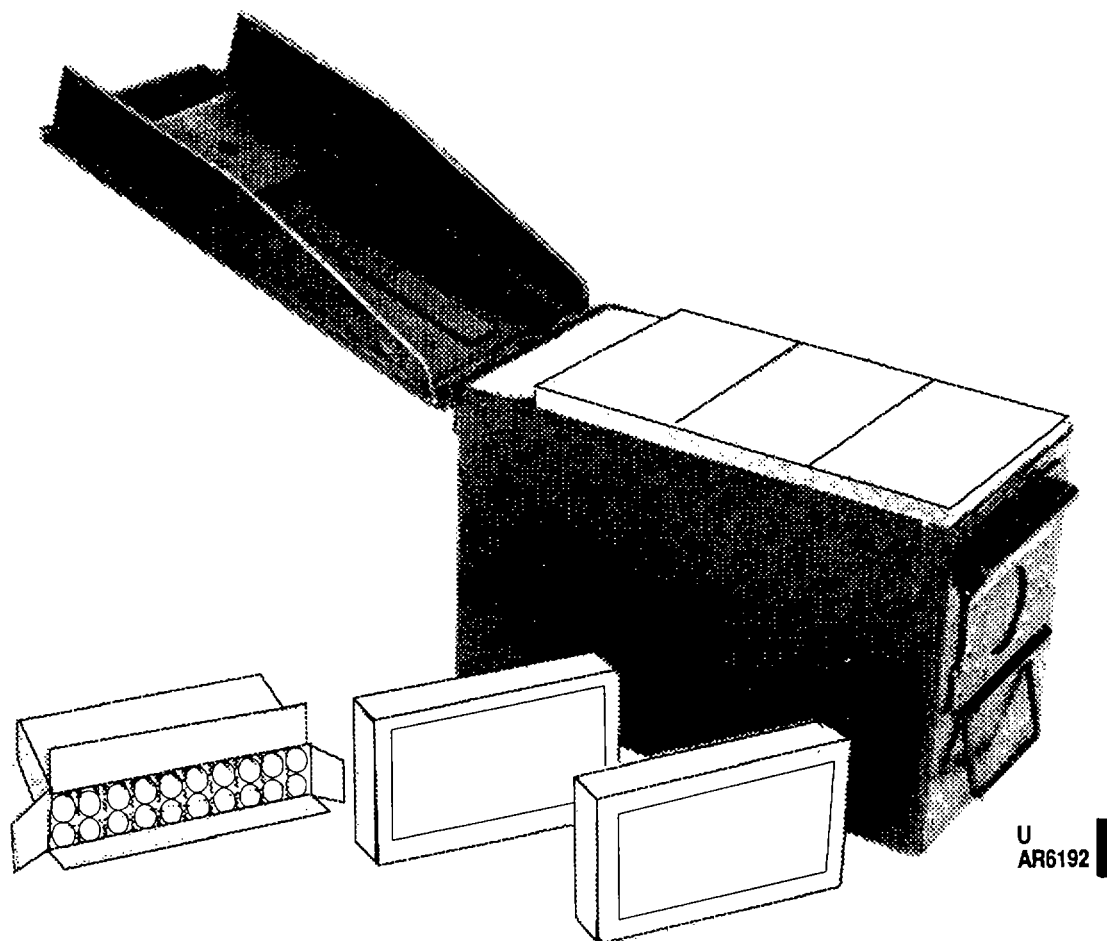

Figure 3-18. Cartridges in 20-round cartons in ammunition box.

munition outlined in chapter 1 and in TM 9-1300-206. In addition:

b. Special Precautions.

(1) Never use oil or grease on small-arms cartridges. Oil or grease might produce excessive and hazardous chamber pressures in weapons when fired and cause damaging abrasives to collect in automatic weapons.

(2) Whenever practicable, store small-arms ammunition under cover. This applies particularly to tracer and shotgun ammunition.

(3) Segregate stored ammunition by caliber, type and ammunition lot.

(4) When only partial boxes of ammunition are issued or contents are not used, protect ammunition remaining in box by firmly fastening cover.

Precautions to be taken in firing and handling of ammunition in the field, as prescribed in chapter 1 and in AR 385-63, TM 9-1300-206 and TM 43-0001-27, apply generally. In addition, observe the following:

a. Do not fire ammunition until it has been identified by ammunition lot number, and until TB 9-1300-385 has been checked to determine whether lot has been suspended or restricted.

b. Do not fire cartridges which have been mashed or perforated, or those having loose bullets or projectiles.

c. Never use armor-piercing (AP, API and APIT) ammunition in training demonstrations involving manned tanks and vehicles.

3-22. Precaution in Firing

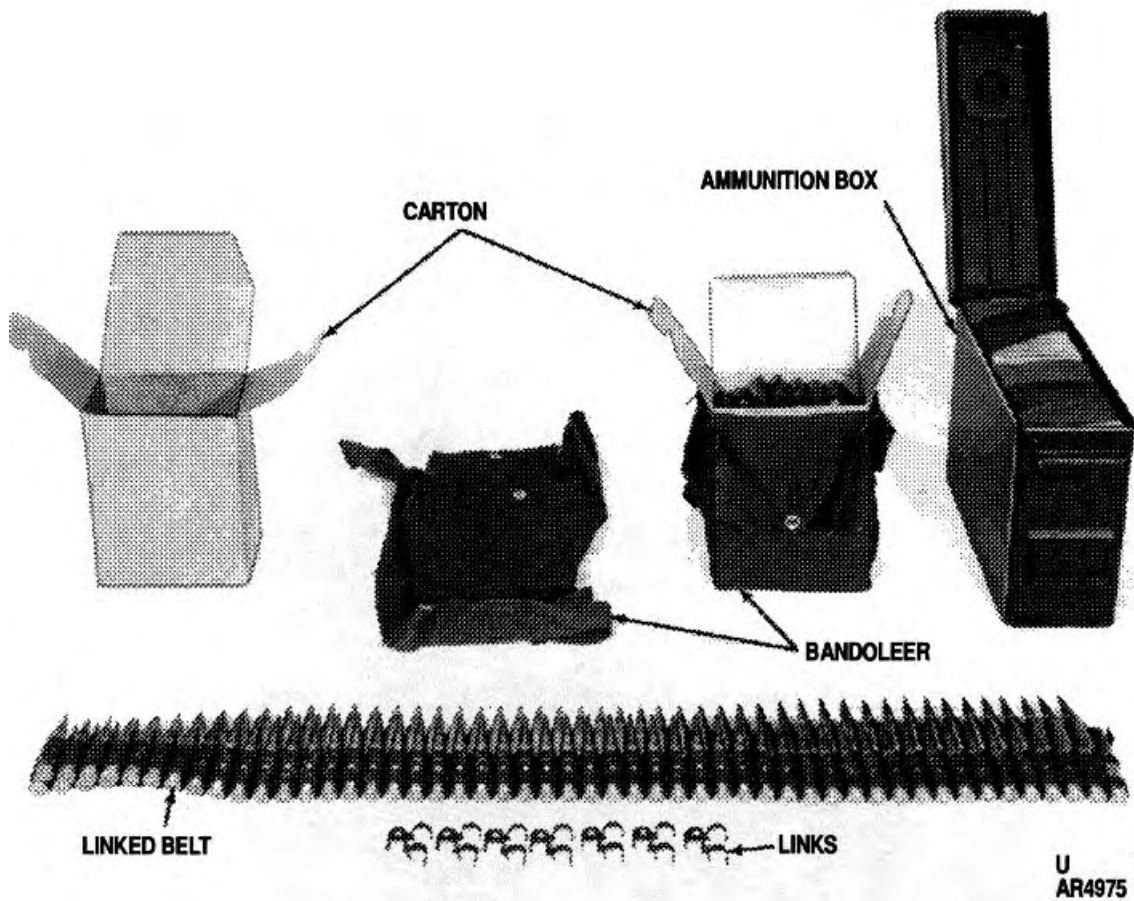

Figure 3-19. Cartridges, link belt, cartons, bandoleers and. ammunition box.

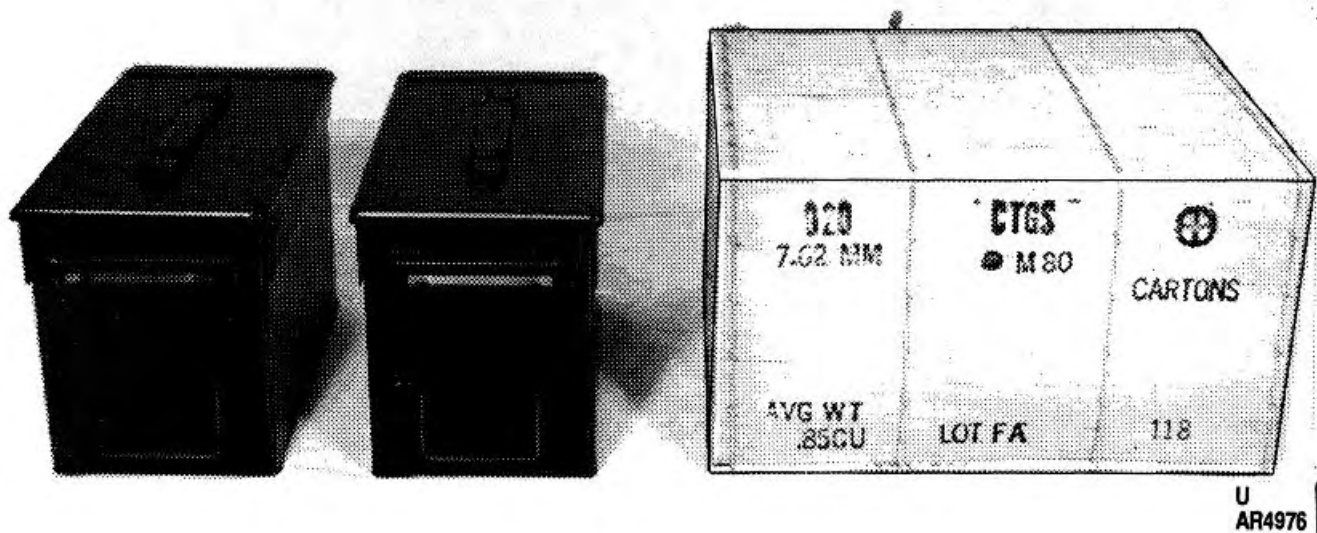

Figure 3-20. Ammunition boxes in wirebound box.

NOTE

In using armor-piercing ammunition, it is well to remember that the core of a bullet that fails to penetrate the target may ricochet. The radius of ricochet for armor-piercing bullets depends on several factors, but may safely be taken at a maximum of 100 yards for caliber .30 and 7.62-mm bullets, 200 yards for caliber .50 bullets, and 500 yards for 20mm projectiles.

d. Do not fire cartridges elevated, as by exposure to direct radiation of sun or other sources of heat, to temperatures of +135°F. or more. Dangerously high chamber pressures may result. When returned to lower temperatures, these cartridges are safe to fire.

e. Do not permit cartridge to remain in chamber of very hot weapon when firing is interrupted; remove round promptly to prevent cook-off.

CHAPTER 4

ARTILLERY AMMUNITION

Section I. GENERAL

4-1. Scope

Artillery ammunition is designed for use in guns, howitzers, mortars and recoilless rifles ranging from 37 millimeters through 280 millimeters. This type of ammunition is covered in detail in TM 43-0001-28. Typical rounds and major components are treated in general terms below.

4-2. Identification

Ammunition is identified by painting and marking on the packing container, on the item proper, and/or on individual components. These markings include, as appropriate, Federal stock number, Department of Defense Ammunition Code, caliber and type of weapon, type and model of projectile/cartridge, weight, zone markings, ammunition lot number and loader's symbol, functional markings, characteristics, and other appropriate information. See chapter 1 for detailed information on painting and marking.

4-3. Classification

Artillery ammunition is classified according to filler as chemical, inert or explosive. It is classified according to use as service, practice, blank or dummy.

a. Service Ammunition. Depending upon the type of projectile, service ammunition is classified as antipersonnel (APERS), high-explosive (HE), high-explosive rocket assisted (HERA), high-explosive plastic (HEP), high-explosive antitank (HEAT), armor-piercing (AP) or armor-piercing capped (APC) (with explosive filler), hypervelocity armor-piercing (HVAP), armor-piercing discarding sabot (APDS), high-explosive dual purpose (HEDP), incendiary, canister, chemical (gas or smoke), illuminating or leaflet.

b. Practice Ammunition. Target practice (TP) ammunition is used for training in firing the weapon. (Inert-loaded items designed for use with delivery systems are considered practice ammunition.) In most instances, target practice ammunition simulates a

service round in weight, configuration and ballistic properties. It is used because it is less expensive and less hazardous. While the propelling charge is live, the projectile may be inert, or have a small quantity of explosive filler, such as black powder, to serve as a spotting charge.

c. Blank Ammunition. Blank ammunition is used for simulated fire. In certain artillery weapons, it is used for limited firing practice, maneuvers and saluting. Blank cartridges contain black powder, but no projectiles.

d. Dummy Ammunition. This kind of ammunition represents, or looks like actual items. However, it is not designed for use in conjunction with delivery systems. (Inert-loaded items not designed for use with delivery systems are considered dummy ammunition). Lack of internal, functional components makes dummy ammunition suitable for exhibits (e.g., permanent museum displays), for such training operation as assembly and handling, and for dry-run operation of weapons and weapon systems.

4-4. Types

Artillery ammunition comprises several types designed (fig. 4-1) for ease in handling and loading. Fixed rounds are used in gun cannons and recoilless rifles; semifixed, in howitzers and mortars; separated, in tank and anti-aircraft guns; and separate-loading, in large caliber guns and howitzers.

a. Fixed. In this type of ammunition, the complete round is issued with the cartridge case (containing a nonadjustable propelling charge and a primer) permanently crimped or otherwise attached to the projectile. The complete round is loaded into the weapon as a unit.

b. Semifixed.

(1) In howitzer ammunition, the cartridge case is loose-fitted over the base of the projectile.

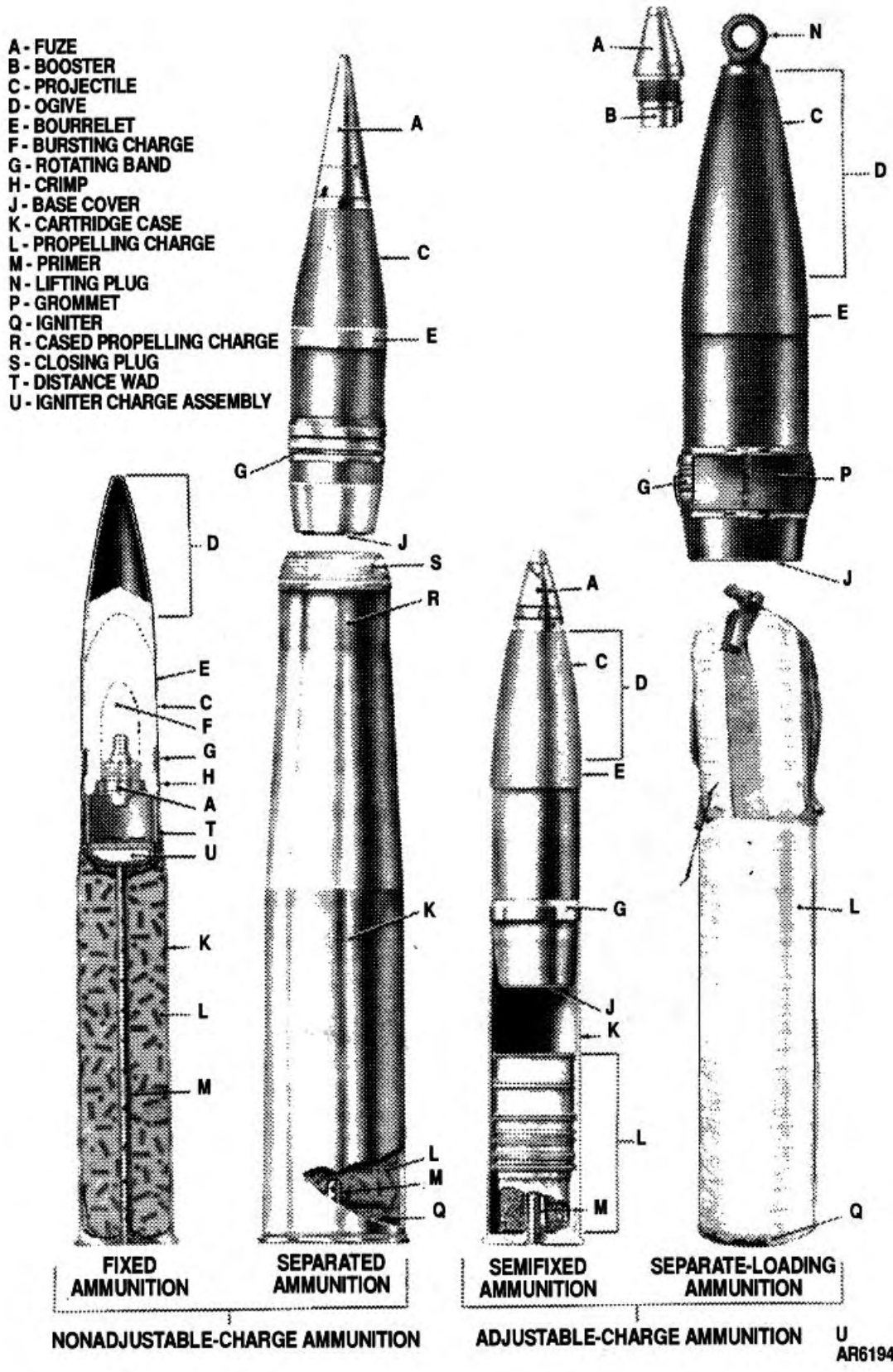

Figure 4-1. Types of complete rounds

The propelling charge, bagged inside the cartridge case, can be adjusted to obtain the desired range. The complete round, like that of fixed ammunition, is loaded into the weapon as a unit.

(2) In mortar ammunition, an adjustable propelling charge, either sheet or granular, is attached to either the mortar fins or the cartridge container. At the base of the mortar projectile is the ignition cartridge; also, the primer, which initiates the propellant after the projectile is dropped into the mortar tube.

c. *Separated.* Separated ammunition consists of a sealed projectile and a sealed, primed cartridge case containing a propelling charge. The propelling charge is nonadjustable. To facilitate handling, the cartridge case and the projectile are lifted onto the loading tray in two

separate operations; however, the complete round is loaded into the gun and rammed as a unit.

d. *Separate-loading.* In separate-loading ammunition, the major components-projectile, propelling charge and primer-are issued unassembled and are loaded into the weapon separately. This type of projectile is generally issued unfuzed, with an eyebolt lifting plug threaded in the fuze well. (Fuzes are assembled to the projectile in the field.) The projectile is inserted into the breech and rammed. Thus, the rotating band seats in the forcing cone. The propelling charge, loaded in cloth bags, is adjustable. It is loaded into the weapon immediately to the rear of the projectile. After the breechblock has been closed and locked behind the charge, with igniter, the primer is inserted into the firing mechanism of the breechblock.

Section II. COMPLETE ROUNDS

4-5. General

A complete round of service ammunition comprises all components used in firing a weapon once: projectile, cartridge case and/or propelling charge, primer and fuze. Complete rounds of several different types are shown in figure 4-1. The major components of a complete round are described below.

4-6. Projectile

a. *Ogive and Windshield.* The forward portion of the projectile from the bourrelet to the point is called the ogive. The length of the ogive influences the flight of the projectile. In older projectiles, the generated radius of the ogive varied from 6 to 11 calibers. Projectiles of recent design, however, have long ogives of radii that exceed these values appreciably. Since kinetic-energy, armor-piercing projectiles have an ogive with a short radius, for purposes of penetration, a windshield is placed over the armor-piercing head to impart desirable ballistic qualities to the projectile.

b. *Bourrelet.* The bourrelet is the machined surface that bears on the rifling lands of the weapon tube. It centers the front end of the projectile in its travel through the bore. Generally, the bourrelet is located in the forward end of the projectile, immediately behind the ogive. Some projectiles of large caliber have front and rear bourrelets.

c. *Body.* While generally applicable to the entire projectile, the term, body, is used to designate the cylindrical portion of the projectile between the bourrelet and the rotating band. It is generally machined to a smaller diameter than the bourrelet to reduce the

surface in contact with the lands of the bore. Only the bourrelet and rotating band bear on the lands.

d. *Rotating Band.* The rotating band is a cylindrical ring of comparatively soft metal, or similar substance. It may also be of steel pressed into a knurled or roughened grooves near the base of the projectile (or attached to the base of the projectile, as in the 4.2-inch mortar). The rotating band affords a closure for the projectile in the forcing cone of the weapon in separate-loading projectiles and centers the rear end of the projectile in the bore of the weapon. In fixed ammunition, the rotating band may not seat in the forcing cone until the instant of initial movement upon firing. As the projectile moves forward, the rotating band is engraved by the lands of the bore. Metal displaced during the engraving process flows into annular relief grooves (cannelures) cut in the rotating band. In the case of 4.2-inch mortar projectiles, the rotating band is bell shaped; it is expanded into the grooves of the mortar rifling by pressure of the propellant gases on a pressure plate. Since the rifling of the weapon is helical, engagement with the band imparts rotation to the moving projectile. The rotating band also provides obturation. It prevents escape of the propellant gases forward of the projectile by completely filling the grooves of the rifling. In the case of recoilless rifle projectiles, the

rotating band is pre-engraved. Some projectiles may be provided with two rotating bands or an obturating band and a rotating band.

e. *Type of Base.* When the surface to the rear of the rotating band is tapered or conical, it is known as boat-tailed; when cylindrical, the projectile is described as having a square base. Nonrotating projectiles have fins at the rear for stabilization.

f. *Base Plug.* All base-ejection, chemical projectiles are closed at the base with steel plugs either threaded to the projectile or secured by shear pins. Some armor-piercing projectiles are also closed with base plugs. The base plug may or may not contain a tracer or fuze.

g. *Base Cover.* The base cover, a thin metal disk,

is crimped, caulked or welded to the base of the projectile. HE rounds are provided with base covers. These give additional assurance hot gases of the propelling charge will not penetrate the base of the projectile and come in contact with the explosive filler. Caulking or sealing rings, rather than base covers, are ordinarily provided for projectiles with HE fillers and BD fuzes.

h. *Tracer.* A tracer in the base of some projectiles provides for observation of fire. The tracer in certain aircraft and antiaircraft projectiles contains a shell-destroying (SD) element. The tracer, after burning a prescribed number of seconds, ignites a pellet. This detonates the explosive filler

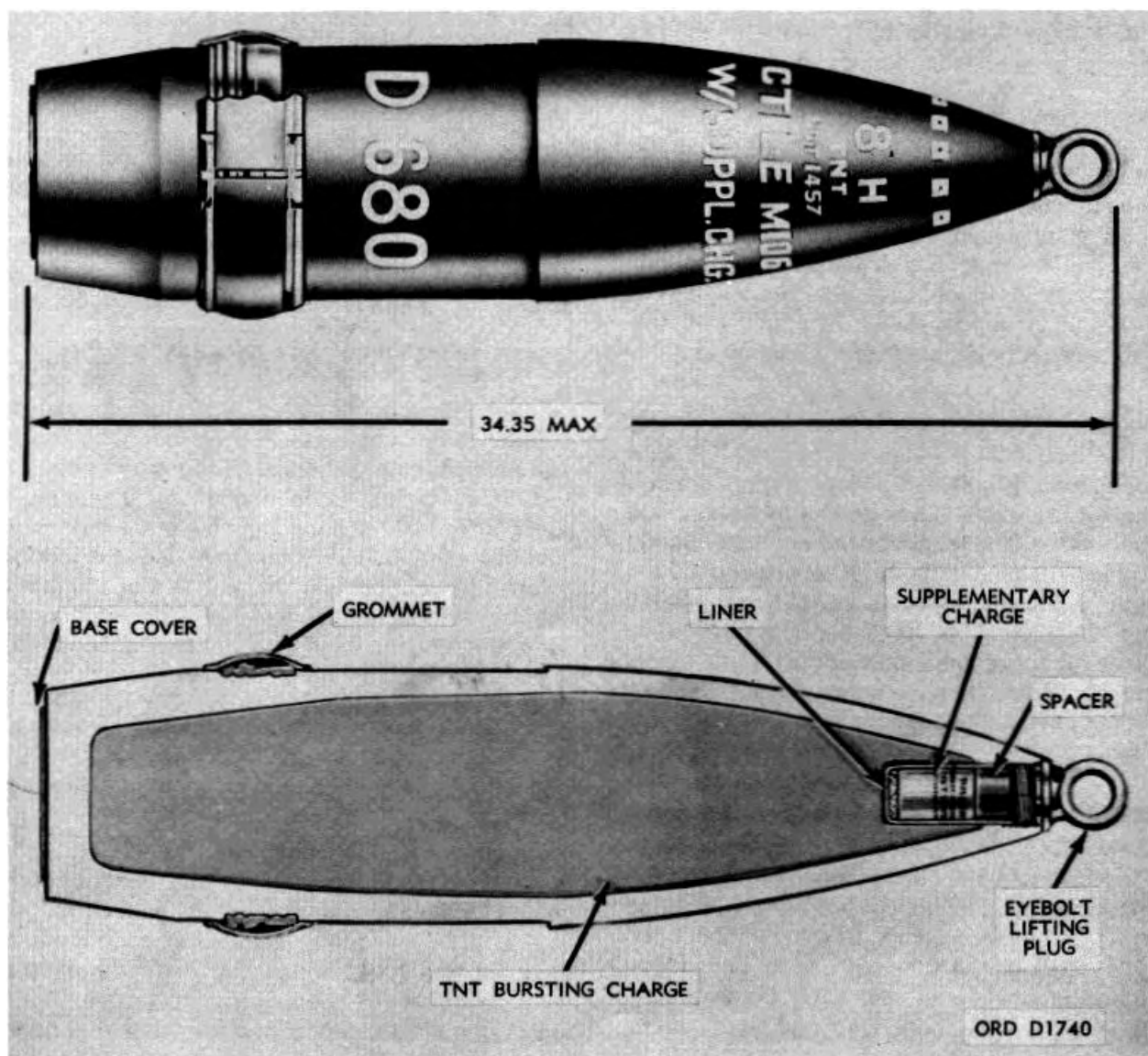
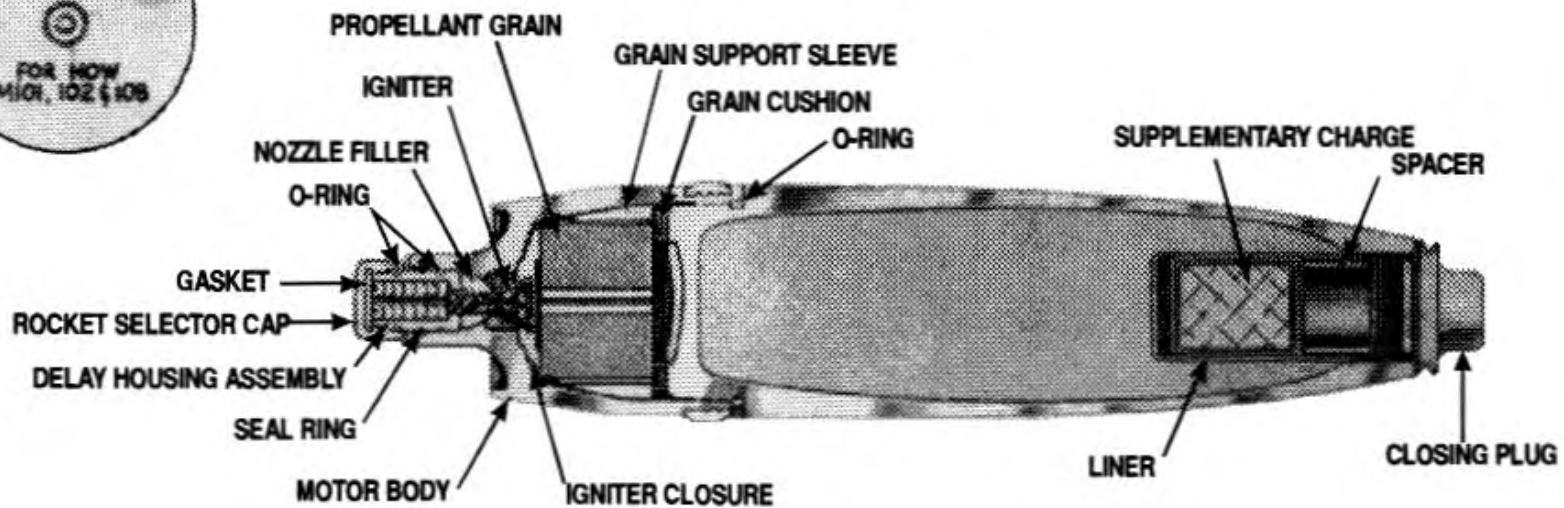
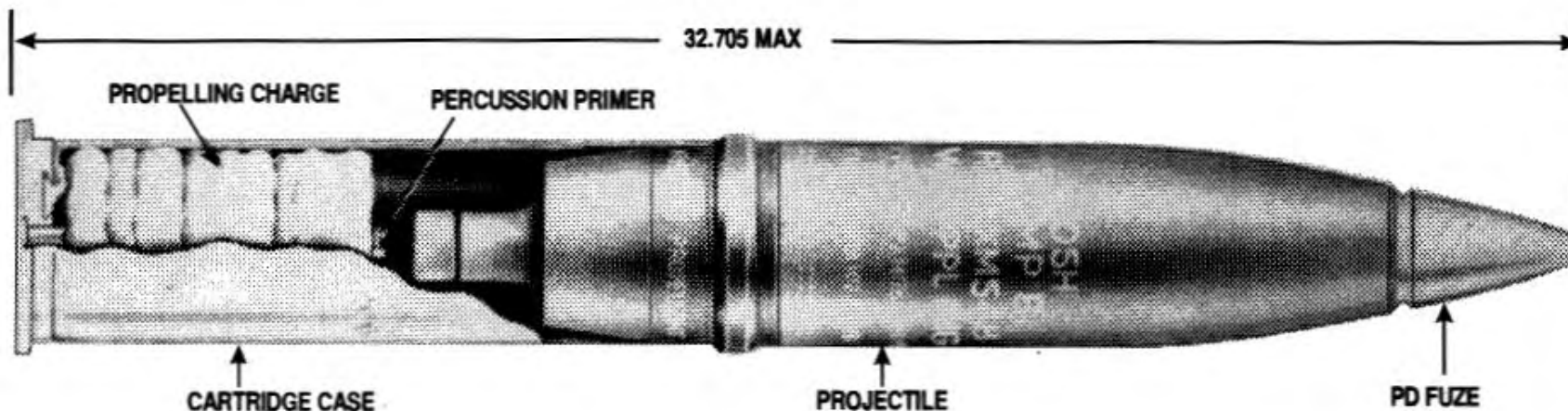

Figure 4-2. High-explosive projectile.



U
AR6196

Figure 4-3. High-explosive rocket-assisted projectile.

and destroys the round, should the round fail to impact against the target.

i. Types of Projectiles.

(1) *High-explosive (HE).* This type of projectile (fig. 4-2), usually made of forged or cold extruded steel, has comparatively thin walls and a large bursting charge of high explosive. It is used against personnel and materiel targets, producing blast or mining effect and fragmentation at the target. It may be fitted with time or impact, concrete-piercing, or proximity (VT) fuze, according to the type of action desired.

(2) *High-explosive rocket-assisted (HERA).* The high-explosive rocket-assisted projectile (fig. 4-3) is an HE projectile with a rocket motor assembled to the base. The projectile functions as a normal HE projectile if the rocket selector cap remains in place. If the rocket selector cap is removed, the propellant gases ignite the pyrotechnic delay mixture, which then ignites the rocket propellant in flight. Functioning of the rocket motor adds thrust to the projectile, increasing its range.

(3) *High-explosive plastic (HEP).* Description and functioning of this ammunition are classified. See TM 43-0001-28-1.

(4) *High-explosive antitank (HEAT).* This is a high-explosive shaped-charge projectile (fig. 4-4) used against armor plate. Its effect is dependent upon the shape of the charge. A conical windshield or spike

assembly provides standoff for the charge. The round is fitted with a BD or PIBD fuze having nondelay action.

(5) *Chemical.*

(a) *Bursting type (fig. 4-5).* These projectiles are similar in external appearance to HE projectiles and have similar ballistic properties. The steel projectile has a centrally oriented burster type containing an explosive burster and is fitted with a mechanical time fuze. The projectile is loaded with persistent gas or with white phosphorus. When the fuze functions, the burster is detonated. This ruptures the projectile body and disperses the chemical filler.

(b) *Base-ejection type (fig. 4-6).* These projectiles are the base-ejection type containing a payload of canisters generally loaded with colored smoke composition. The projectile is assembled with a mechanical time fuze, an expelling charge and a threaded base plug. When the fuze functions, the expelling charge is ignited. This, in turn, ignites and expels the canisters and base plug from the projectile. The burning canisters produce a smoke cloud for screening and spotting purposes.

NOTE
The canister in this type of projectile

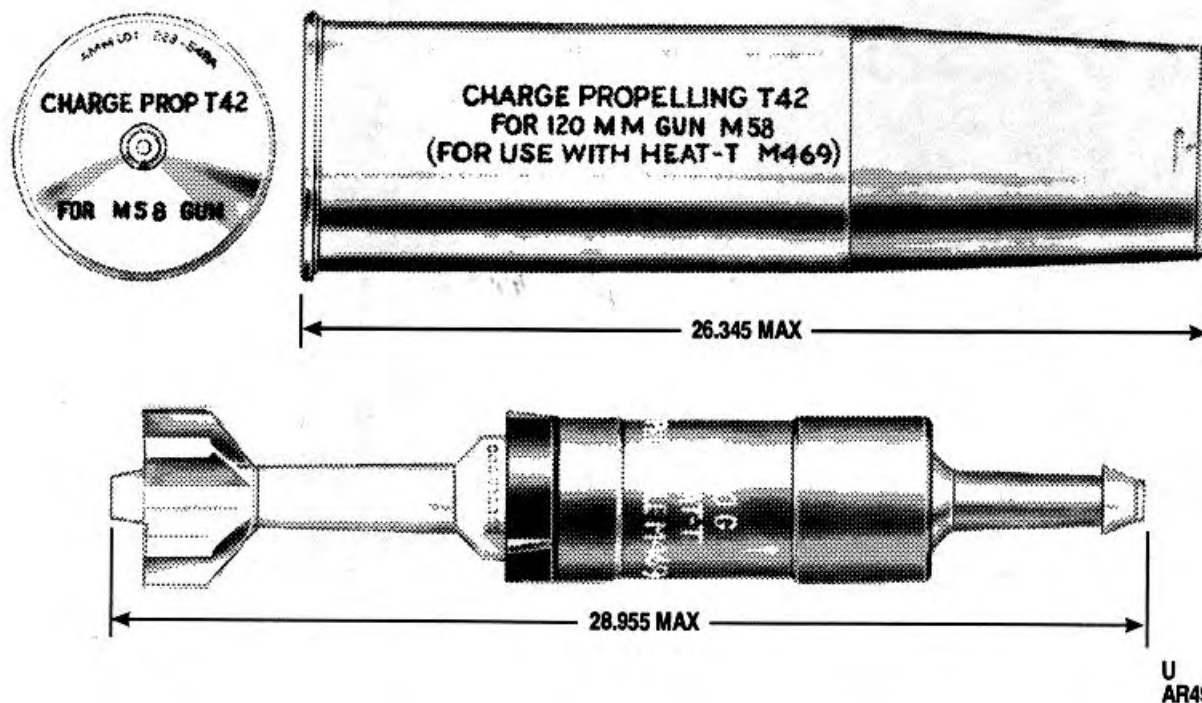

Figure 4-4. High-explosive antitank projectile.

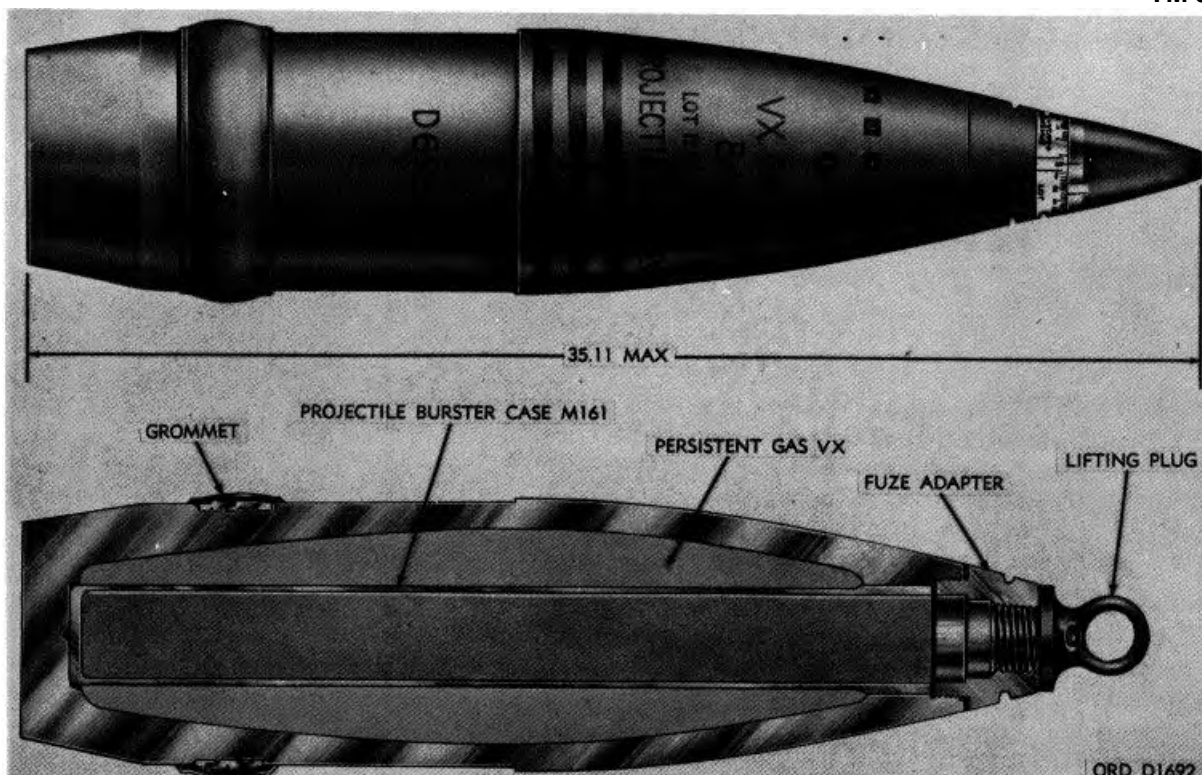

Figure 4-5. Burster chemical projectiles.

should not be confused with the canister that is a component of a fixed-round projectile.

(6) *Illuminating*. This type of projectile (fig. 4-7) is used to illuminate a target area under conditions of reduced visibility. The projectile is hollow and contains a payload consisting of a parachute and illuminant assembly. The illuminant is ignited and the parachute and illuminant assembly are ejected from the projectile by an expelling charge adjacent to a time fuze. The parachute and burning illuminant assembly slowly descend, lighting the target area.

(7) *Armor-piercing*.

(a) *Armor-piercing (AP) projectiles* (fig. 4-8) contain a core of heat-treated, high-carbon alloy steel. The head is hardened steel for penetration of armor. The body is tough to withstand impact and twisting action of the projectile at high angles of obliquity. A windshield is generally secured to the head of the projectile to assure adequate ballistics. A tracer is present in the base of the projectile.

(b) *Armor-piercing capped (APC) projectiles* (fig. 4-9) are designed to penetrate face-hardened armor plate. The nose is capped with forged,

heat-treated alloy steel to have a hard exterior surface and a relatively soft core. On impact, the hardened exterior of the cap destroys the surface of the armor. The softer core of the cap protects the hardened point of the projectile by distributing impact stresses over a large percentage of the area of the head. The projectile ultimately penetrates the target by kinetic energy. A tracer may be present in the base end of the fuze.

(c) *Armor-piercing discarding sabot (APDS) projectiles* consist of a dense core of tungsten carbide covered with a steel sheath and a bore-and-sleeve assembly (sabot). The sabot, which converts the core of the projectile to the same size as the gun barrel, is discarded after the projectile leaves the bore of the weapon.

(d) *Hypervelocity (velocities above 3,500 fps) armor-piercing (HVAP) projectiles* are relatively lightweight with an armor-piercing core of tungsten carbide. The core, a steel base containing a tracer element, an aluminum body and

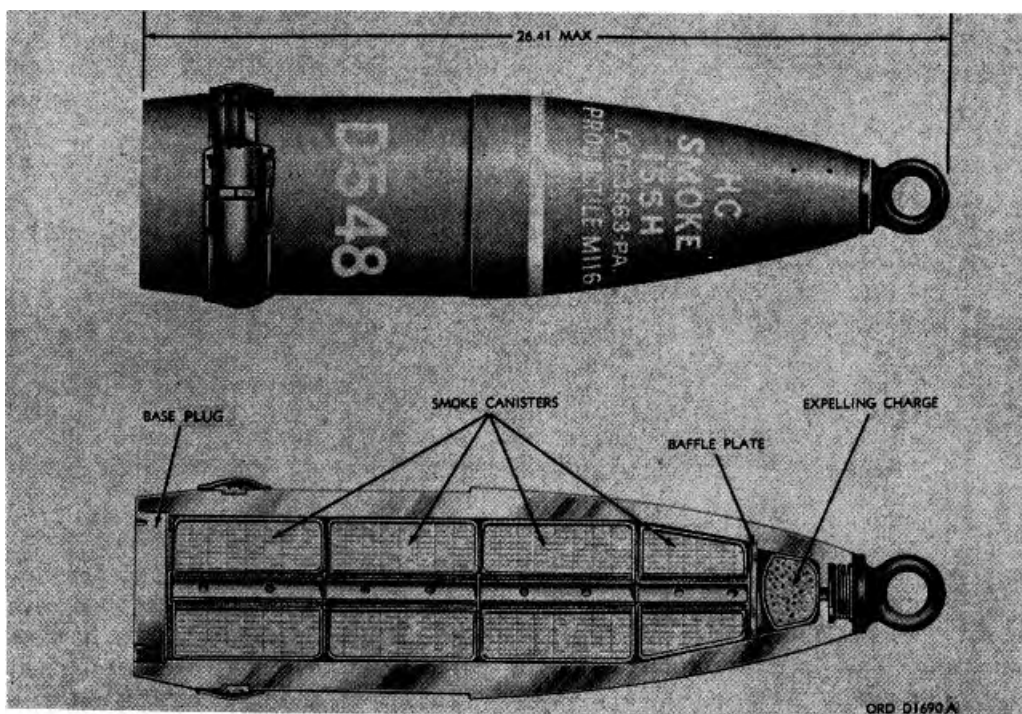

Figure 4-6. BE chemical (smoke) projectiles.

nose plug, and an aluminum windshield comprise the HVAP-T projectile.

(8) *Antipersonnel (APERS)*. Antipersonnel cartridges are employed against enemy personnel and light materiel. The projectile of APERS cartridges (fig. 4-10) carries a payload of flechettes (fin-stabilized steel fragments). These cartridges are fitted with MT fuses which may be set for muzzle action or range.

(9) *Canister*. The canister projectile (fig. 4-11) consists of a light metal case filled with flechettes, steel slugs or, in some projectiles of early design, steel balls. It contains no explosive and is fired point blank at short ranges (up to 600 feet) for effect against personnel. When the projectile leaves the muzzle of the weapon, the case breaks open, scattering the steel slugs or balls in the manner of shot from a shotgun shell. Flechettes are dispersed in conical pattern.

(10) *Leaflet*. These projectiles are essentially

BE projectiles adapted for dispersing literature.

(11) *Improved Conventional Munitions (ICM)*. These munition embody a unique design to control the number, size, and distribution of fragments produced when the munition functions. Projectiles 105MM or larger (fig. 4-6.1), warhead sections (fig. 4-6.2), and cluster bomb units (CBU) (fig. 4-6.3) carry a payload of small, individually fused munitions. These items have fusing and release systems which dispense the submunitions at an altitude sufficient to permit arming prior to striking the target. Hand grenades, 40MM cartridges, and land mines each contain a high-explosive fragmentation unit.

(12) *Dual purpose munitions*. These munitions (fig. 4-16.4) combine the capabilities of penetrating steel armor and inflicting personnel casualties in the vicinity of the target.

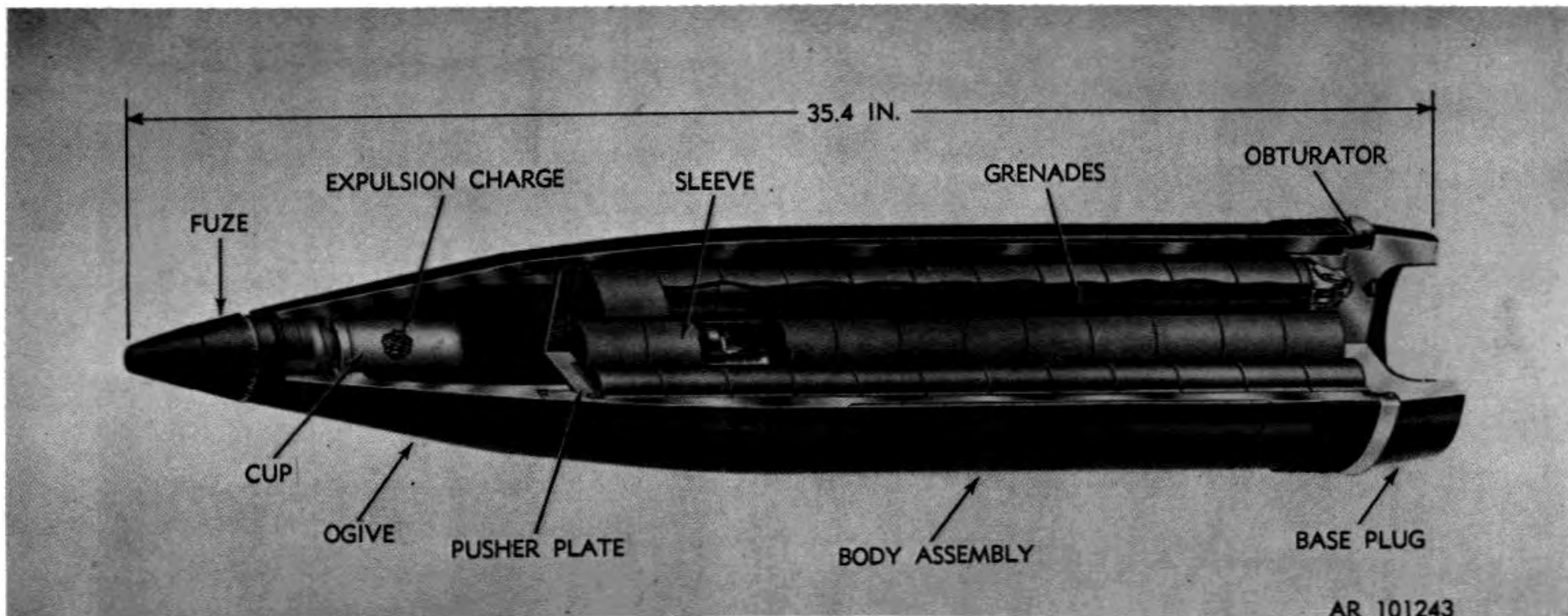

Figure 4-6.1. 155-mm projectile, HE, M483A1..

Change 2 4-8.1

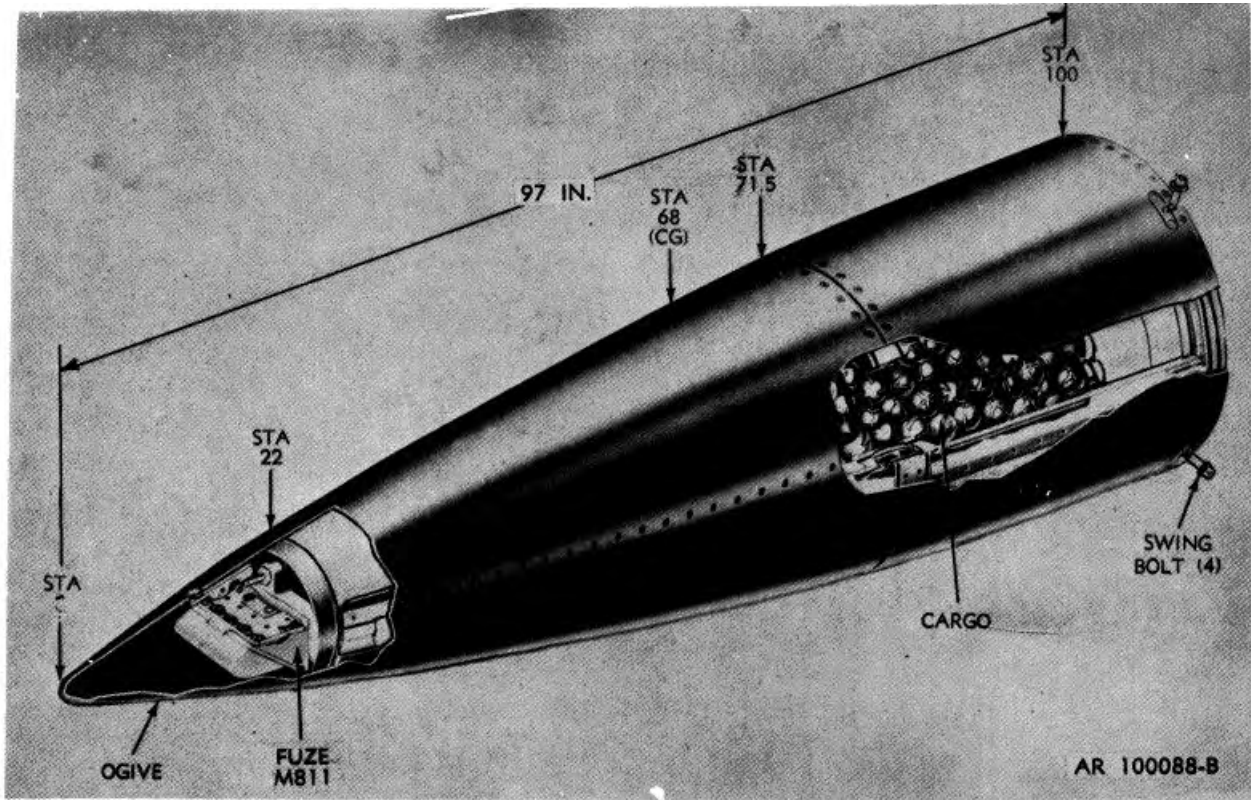

Figure 4-6.2. Warhead M251.

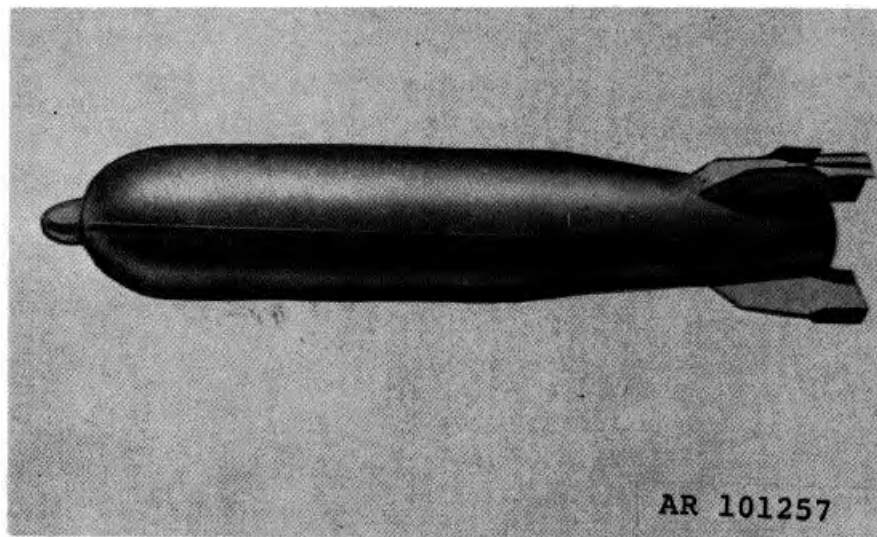

Figure 4-6.3. Typical CBU.

Change 2 4-8.2

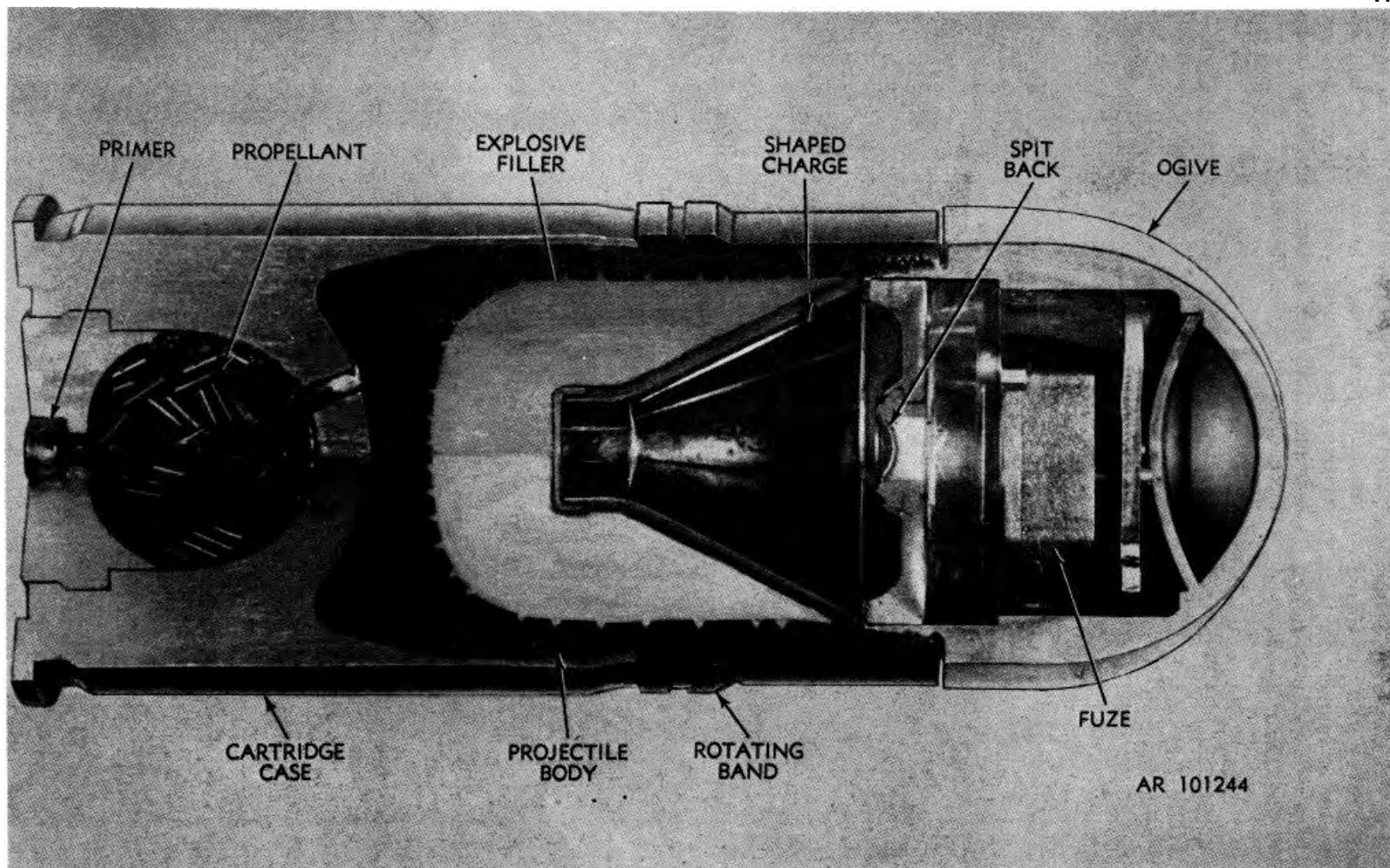

Figure 4-6.4. Dual purpose munition

Change 2 4-8.3

4-7. Cartridge Cases

a. A cartridge case made of drawn brass, spiral-wrapped or multipieced drawn steel, or felted nitrocellulose serves as the container for the - propelling charge in round of fixed, semi-fixed, and separated artillery ammunition. Cartridge case and weapon

chamber generally conform in profile. However, the cartridge case is slightly smaller to facilitate chambering. The base of the metal case is relatively heavy to provide for firm attachment of a primer, and has a flange or groove to permit mechanical extraction. Rounds

Change 2 4-8.4

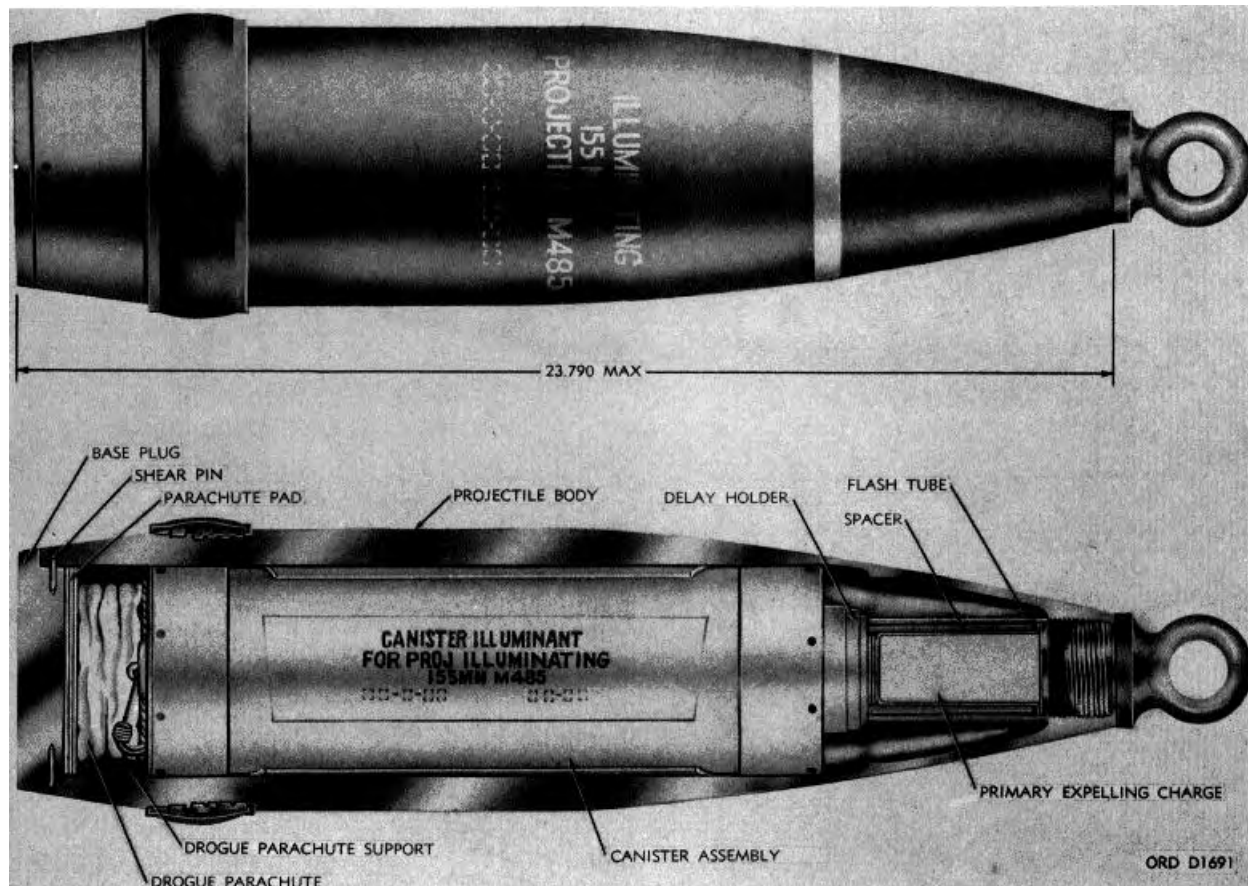

Figure 4-7. Illuminating projectiles.

used in automatic guns have cartridge cases with an extracting groove instead of a flange or rim.

b. In nonadjustable (fixed) rounds, the cartridge case is crimped to the projectile. In adjustable (semifixed) rounds, the case is fitted free to the projectile. In separated ammunition, the case is plugged and separate from the projectile. Having a nonadjustable propellant charge, separated ammunition may be considered a special type of fixed ammunition.

c. Brass or steel cartridge cases of special composition are processed to provide obturation in recoil-type weapons. Obturation, expansion of the cartridge case against the chamber wall under pressure of burning propellant gases, prevents escape of these gases from the rear of the weapon.

d. The cartridge case in recoilless weapons either is perforated or has a rupture disk to allow propellant gases to escape through nozzles in the breech of the weapon. The interior of the perforated type of case contains a liner that covers the perforations in the case. This prevents entrance of moisture and leakage of propelling charge

grains. Liners are made of various materials, such as paper, rayon, plastic, etc. In the rupture-disk type of cartridge case, the propellant is contained in a silk bag positioned around the tail boom or primer tube.

4-8. Propelling Charges

a. Description.

(1) Propelling charges consist of a quantity of propellant in a container (cartridge bag for separate-loading and semifixed ammunition) and an igniter and/or primer. The propellant itself is carefully designed for the particular role of the ammunition. Factors considered include chemical composition, grain size, and charge weight. Propellants are described in chapter 1.

(2) In fixed and semifixed rounds, the igniter charge (black powder) is present in the primer. In some models of separated ammunition, an auxiliary igniter charge is placed around the primer or on the distance wadding to assure proper ignition of the propellant. In most separate-loading rounds, the igniter charge is in an igniter bag

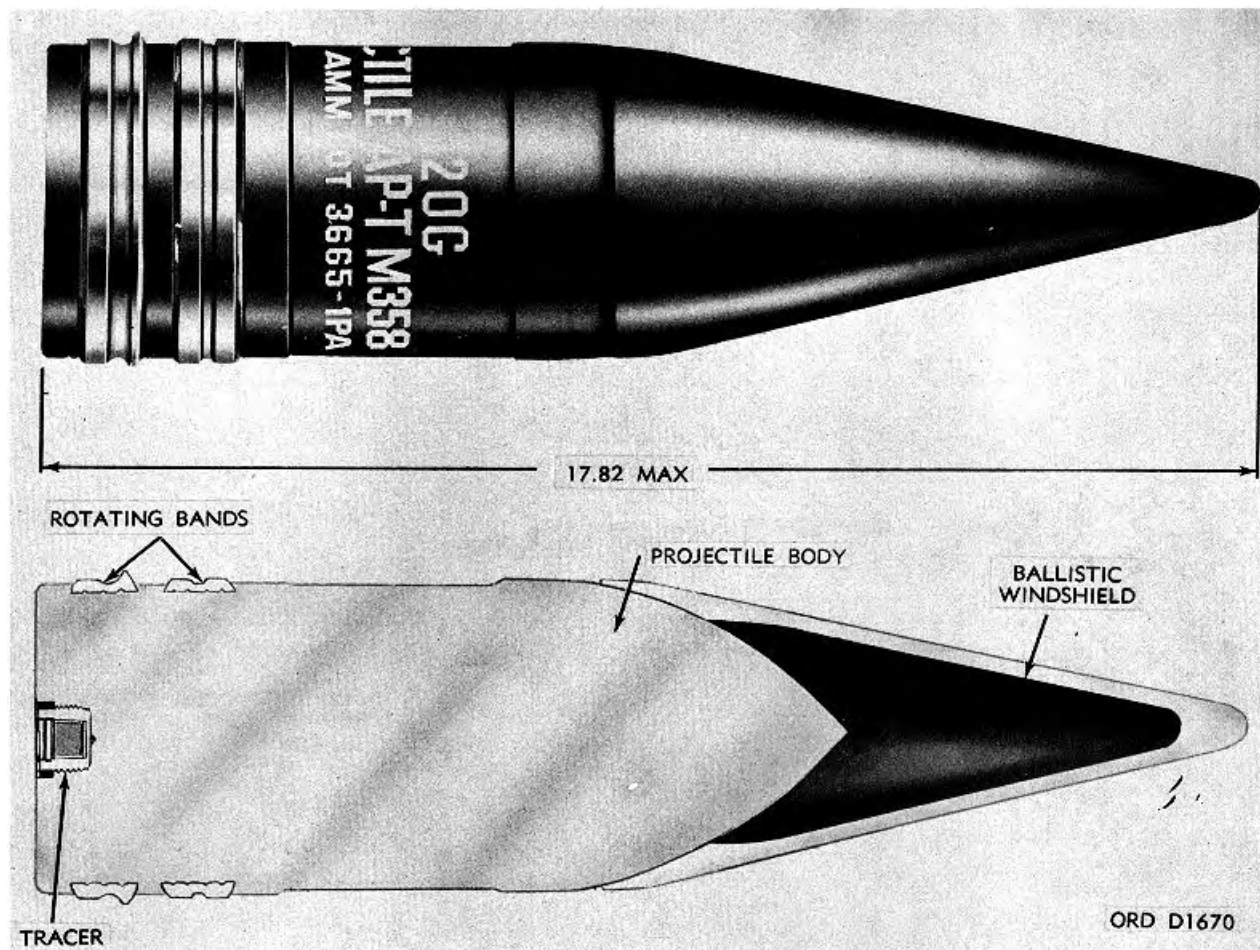

Figure 4-8. Armor-piercing projectile.

sewn to the base end of the propelling charge. In some designs, the igniter forms a core running through the center of the propelling charge bag. Cartridge-igniter pads are made of tightly woven silk or synthetics to prevent the black powder from sifting through. Cloth used for the igniter charge is dyed red to indicate presence of the black powder igniter. Pads of early manufacture (undyed) are marked IGNITER.

b. Types of Propelling Charge. The type of propelling charge depends upon the type of ammunition (fixed, semifixed, separated, or separate loading) and size of the complete round.

(1) *Fixed.* The propelling charge in a round of fixed ammunition is loose (or in a polyethylene or polyethylene/rayon bag) in the cartridge case. When the charge does not fill the case completely, a spacer or distance wadding, usually a cardboard disk and cylinder, is inserted in the neck of the cartridge case, between the charge and the base of the projectile.

(2) *Semifixed.*

(a) In semifixed howitzer ammunition, the charge, which is divided into parts or increments for zone firing, is in several cloth bags. The full charge, with all increments in proper order, is in the cartridge case, which is a free-fit over the rear end of the projectile. Each part of the charge is numbered, the base charge being numbered 1. For example, to arrange a 105-mm propelling charge in proper order for firing charge 4, the increments would be arranged in the order 1, 2, 3, and 4, increment 4 being placed uppermost. (For firing less than full charge, all increments above the charge to be fired are removed.) Dualgran. the charge for 105-mm howitzer ammunition, consists of a charge in which a quick-burning propellant of single-perforated grains is used in charges 1 and 2 and a slow-burning propellant of multi-perforated grains in charges 3, 4, 5, 6, and 7. This charge is used with a long primer (no charge-retaining spring required) and incorporates a lead foil in charge 5 as a decoppering agent. Increments are

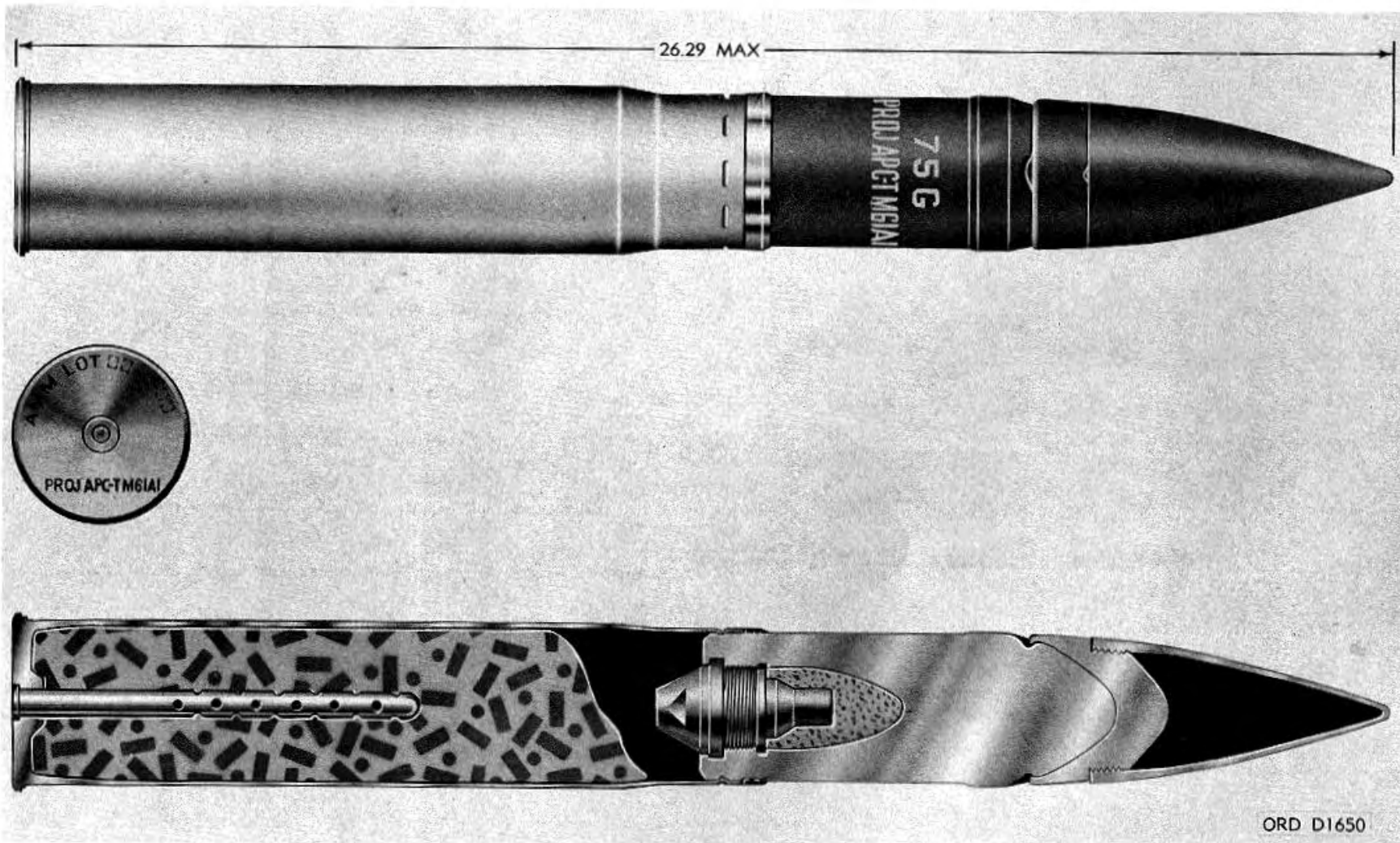

Figure 4-9. Armor-piercing capped cartridge.

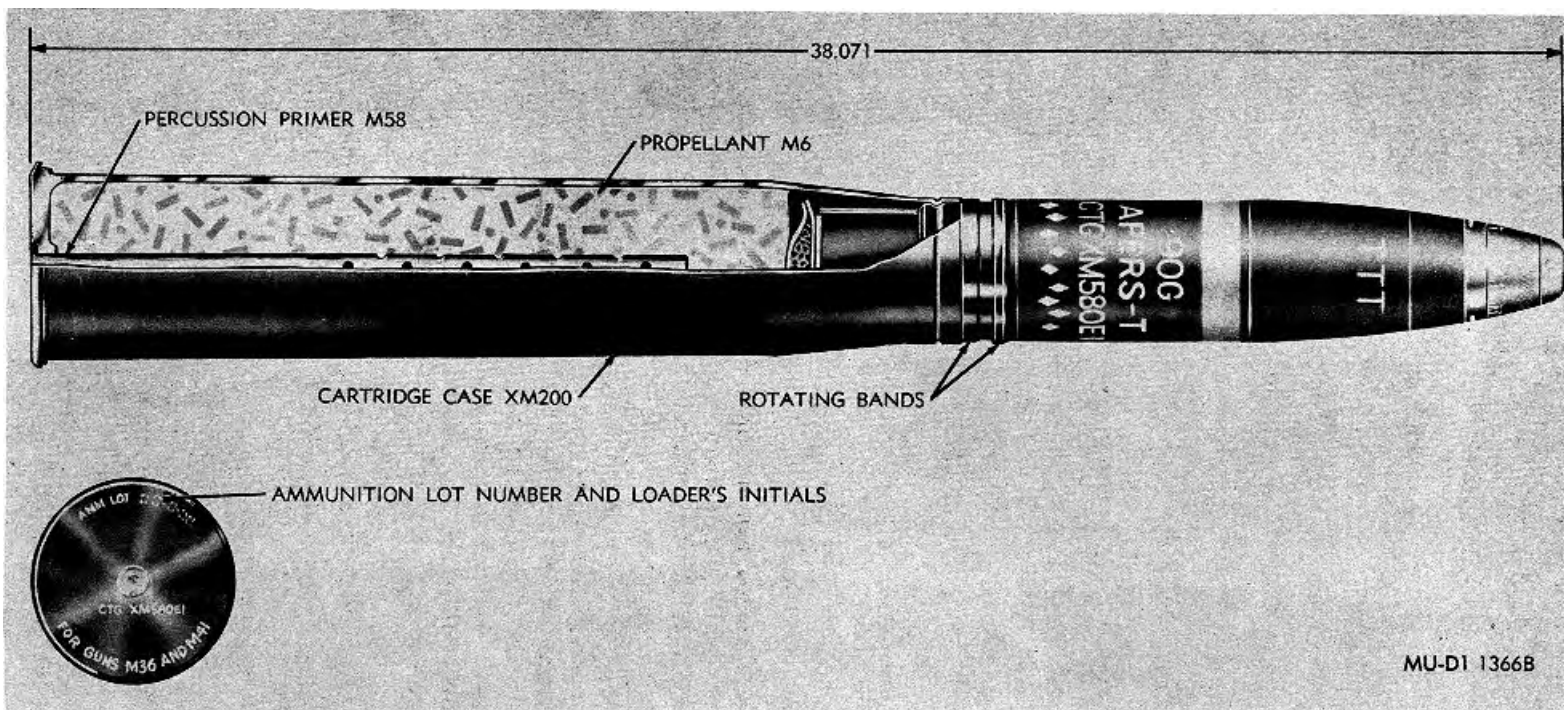

Figure 4-10. Antipersonnel (APERS) cartridge.

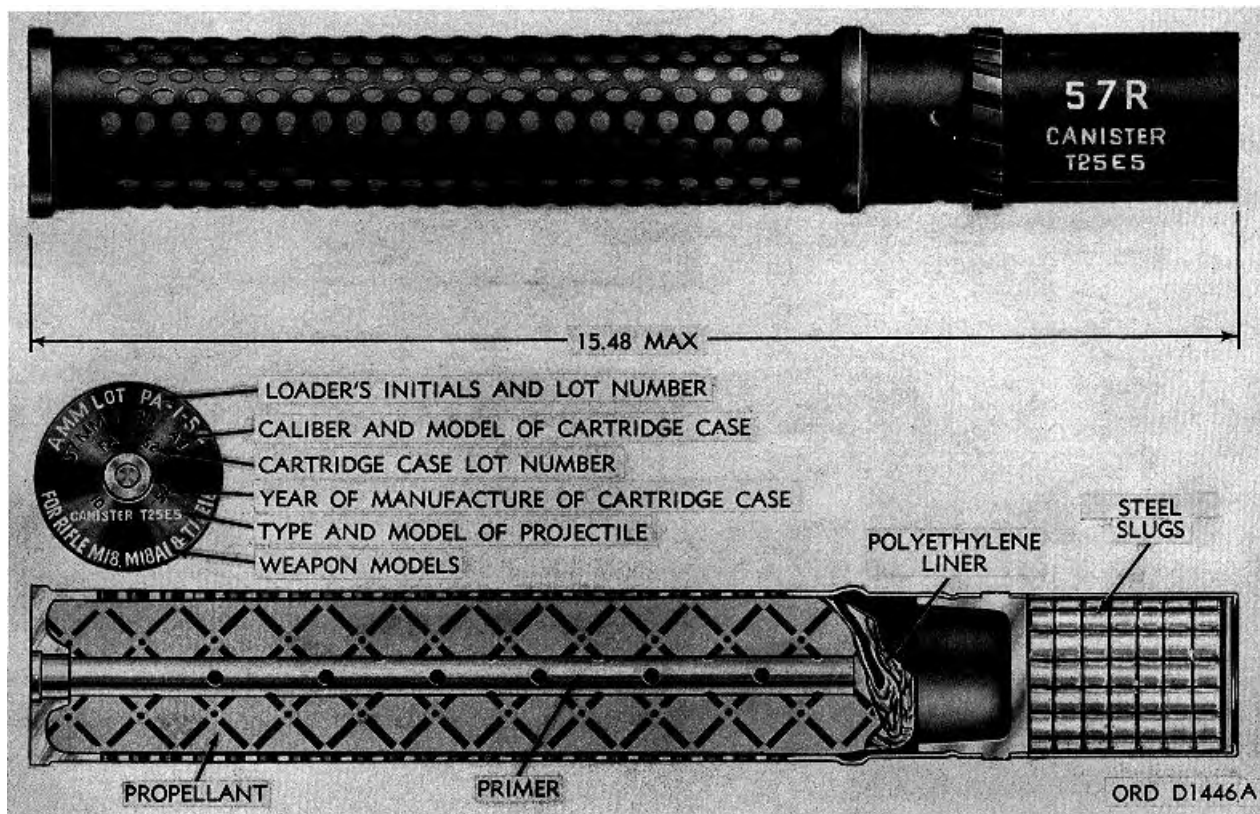

Figure 4-11. Canister cartridge.

of the flat-bag type and are folded around the primer. Less muzzle flash than with single granulation charges, improved uniformity of performance, and greater accuracy are obtained with the dualgran charge.

(b) The adjustable semifixed propelling charges used in mortar ammunition consist of either thin sheets of propellant or bags of granular propellant. In either case, this propellant is fitted around the stabilizing fins or to the cartridge container boom at the base of the projectile.

(3) *Separated.* This propelling charge consists of looseloaded propellant in a primed brass or steel cartridge case closed by a plastic or asphalt composition plug. It is not adjustable.

(4) *Separate-loading.* Propellant in separate-loading ammunition is contained in acrylic cotton cloth bags, divided into multisection charges. This type of charge permits the gun-crew to vary size of the propelling charge and facilitate handling of larger and heavier charges. Multisection charges are subdivided into base-and-increment and unequal-section types.

(a) Base-and-increment. This type of propelling

charge consists of a base section or charge and one or more increments. The increments may be equal or unequal in weight. The base section is



Figure 4-12. Flash reducer.

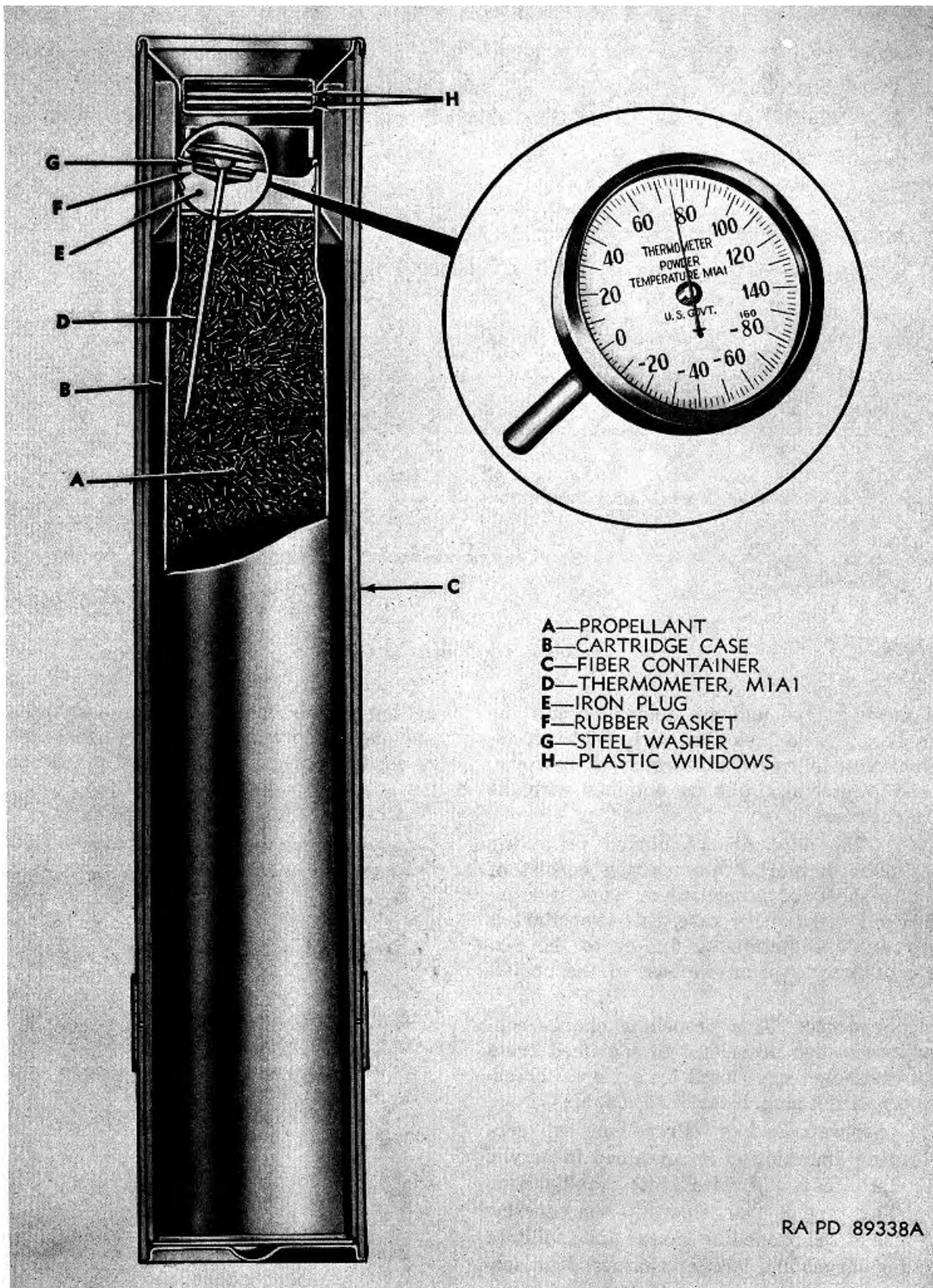

Figure 4-13. Propellant temperature indicator with thermometer.

always fired; the increments may or may not be. An igniter pad is attached to the base end of the base section only. A propelling charge may have a core igniter in the base section and in the increments.

(b) *Unequal section.* In howitzer ammunition, the charge is made up of unequal sections. In gun cannon ammunition, the charge is made up of several equal sections and two or more unequal sections. This type of propelling charge permits firing at reduced velocity and provides maximum flexibility.

(c) *Color.* In certain howitzer ammunition, two base and increment charges are provided, one for inner, the other for outer zone charges (green bag charges) to distinguish them from the outer zone charges contained in undyed (white) bags (white bag charges).

(d) *Flash reducers.* Flash reducers (fig. 4-12), cloth pads filled with flash-reducing salts, are used with certain separate-loading propelling charges to eliminate flash. Used with white bag charges only, in 155-mm and 8-inch howitzers, they are inserted between increments or tied around the base charge. Green bag charges require no flash reducers for these howitzers. The precautions that apply to black powder also apply to flash reducers.

(e) *Propellant temperature indicators.* Propellant temperature indicators (fig. 4-13), used in antiaircraft batteries, make it possible to take propellant temperatures either at battery level or in storage at the ammunition supply point (ASP). A propellant temperature indicator consists of a thermometer inserted into the packed propelling charge (through the fiber container

and cartridge case). The thermometer can be read through plastic lenses placed in the head of the assembly. The assembly is then placed with an ammunition lot so that the temperature may be noted. Since firing tables are based on the temperature of the propellant at +70°F. at the time of firing, any deviation from this temperature has to be considered in making firing data corrections.

4-9. Primers

a. *General.* The primer is that component in a propelling charge explosive train which produces the flame that ignites the propellant.

(1) Artillery primers contain a small quantity of sensitive explosive and a larger quantity of black powder or other propellant in a cylindrical housing of metal, cardboard or other appropriate material. In mortar ammunition, an ignition cartridge, which ignites the propellant, is used with the primer and may or may not be assembled to it. Unassembled, the primer and the ignition cartridge are considered separate components; assembled, the primer becomes a component of the ignition cartridge.

(2) In fixed, semifixed and separated ammunition, the primer and/or ignition cartridge is assembled to the ammunition at the time of manufacture. In separate-loading ammunition, the primer is inserted into the breechblock of the weapon by the user immediately prior to firing.

b. *Types.* Most artillery primers are classified according to the method of firing as electric, percussion, and percussion-electric.

(1) *Electric.* This type of primer is fired by heat generated when an electric current passes

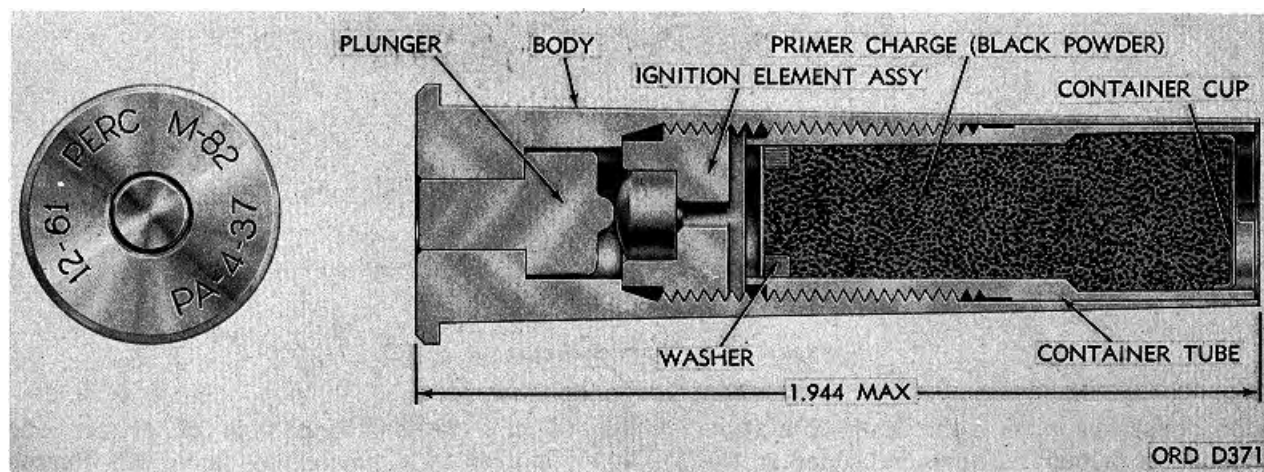

Figure 4-14. Percussion primer.

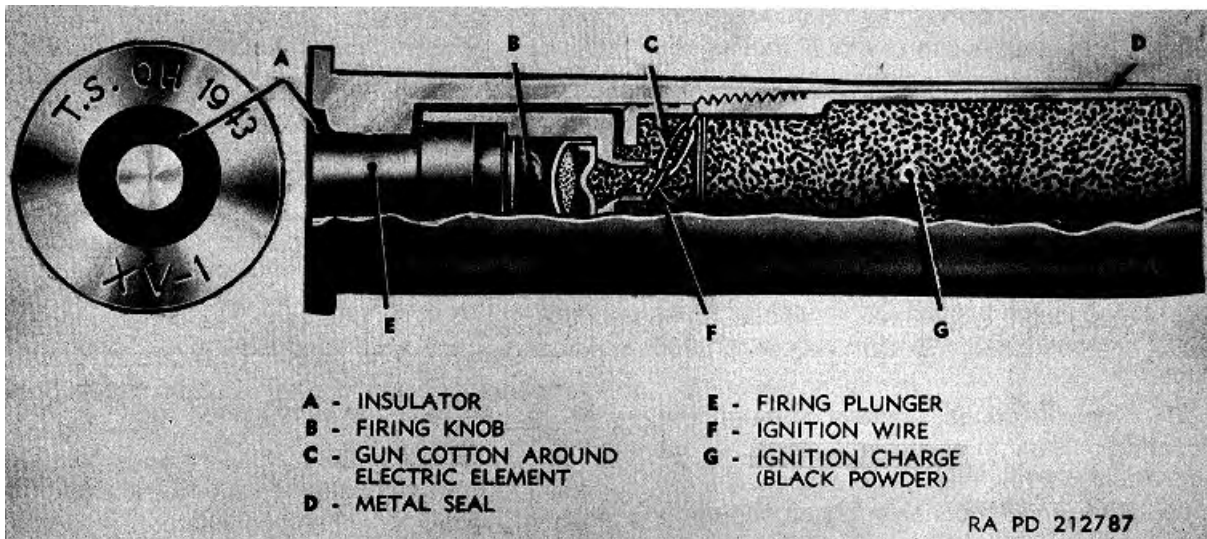

Figure 4-15. Combination electric and percussion primer.

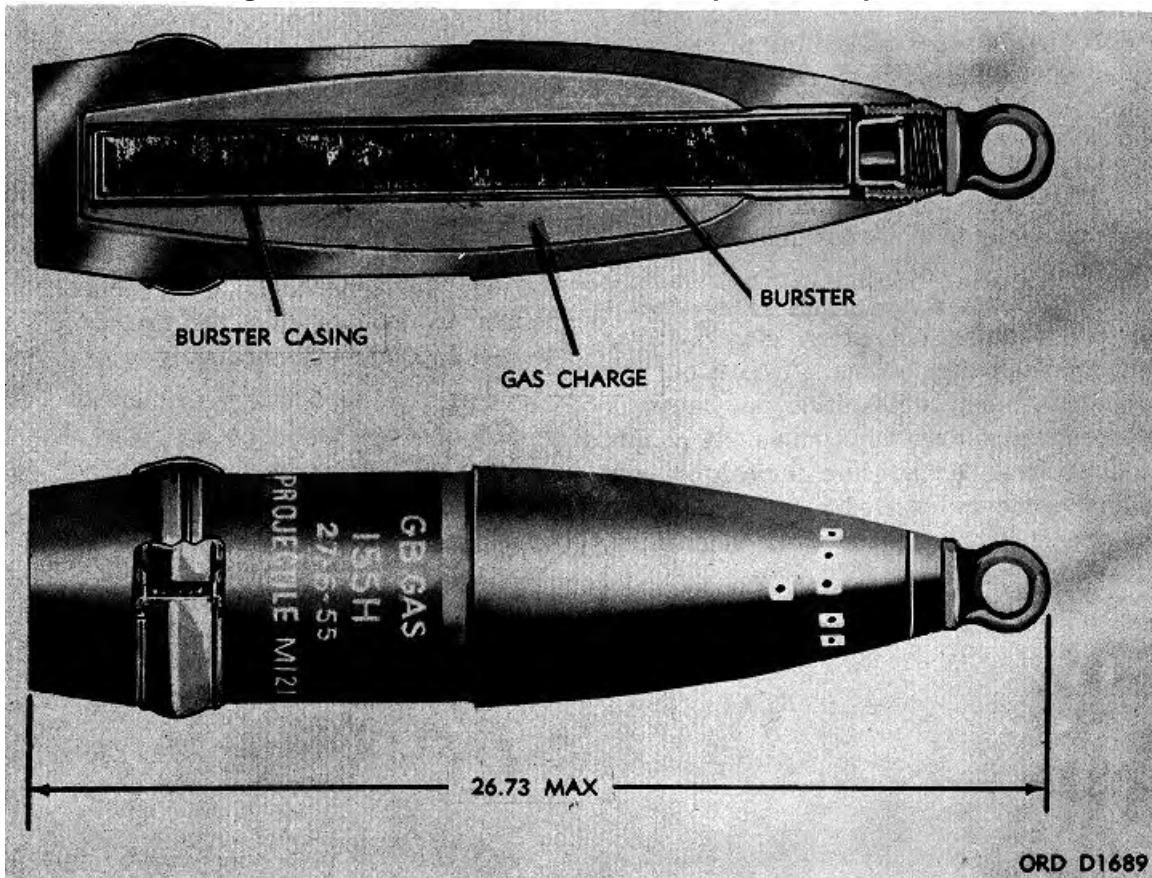

Figure 4-16. Burster charge

through a resistance wire in the ignition mixture or a conductive primer mixture embedded in the primer. The electric primer is distinguished by the black insulation that surrounds it in the head of the cartridge case

(2) *Percussion.* This type of primer (fig. P14) is fired by a blow of the firing pin. Percussion primers used in fixed, semifixed and separated artillery ammunition contain sufficient black powder to ignite the propellant in the cartridge

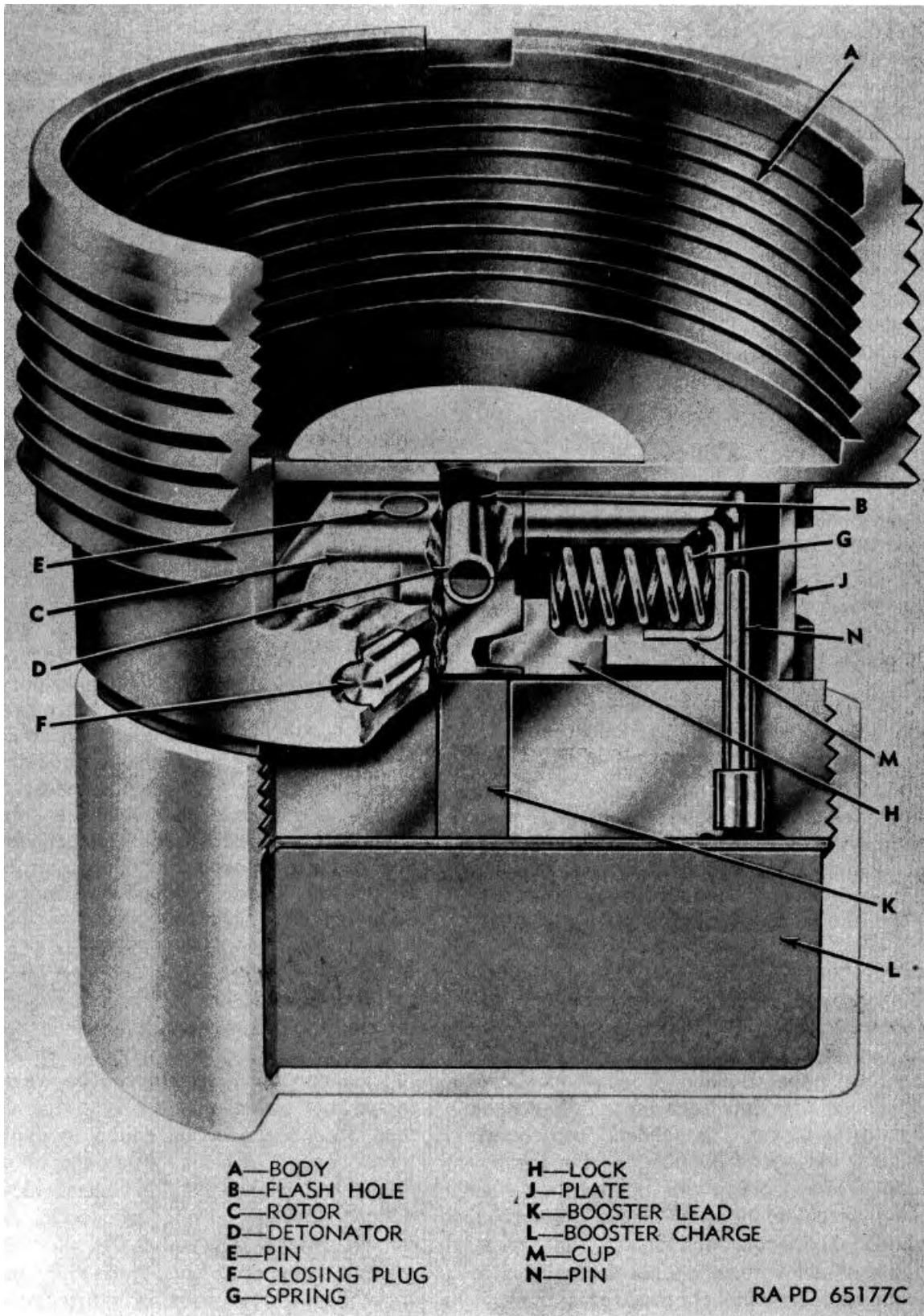

Figure 4-17. Booster charge.

case. Those used with separate-loading propelling charges contain only enough black powder to ignite the igniter charge attached to the propelling charge.

(3) *Percussion-electric*. This type of primer (fig. 4-15), fired either electrically or by the blow of a firing pin, is used with separate-loading rounds.

4-10. Burster Charge

A burster charge (fig. 4-16) is an auxiliary high explosive element used in certain types of chemical projectiles to rupture the projectile and disperse the chemical agent. It consists of a high-explosive charge in a metal tube which is contained in the projectile burster casing. It may be used in conjunction with the burster initiator used in 75mm, 76-mm, and 90-mm chemical projectiles.

4-11. Booster Charge

a. Since burster charges in high-explosive projectiles are relatively insensitive to shock, a comparatively large detonating charge is necessary to

assure high order detonation. Use of more sensitive explosives, such as mercury fulminate or lead azide, in the quantities required would create excessive hazards in handling and firing. Consequently, such explosives are used only in small amounts as initiating and intermediate detonating charges. A separate charge of somewhat less sensitivity (usually tetryl) is provided for detonating the high-explosive charge. Because it increases or boosts effectiveness of the explosive train, this charge is known as a booster charge.

b. The booster charge (fig. 4-17) may be incorporated in the fuze itself. It may also be encased in a thin casing of metal or plastic attached to a threaded metal body.

c. Boosters are generally provided with a boresafety mechanism (arming delay) and incorporate, in addition to the main charge, one or more other charges (e.g., a detonator and a booster lead charge). Some boosters incorporate delay arming mechanisms which prevent arming until the projectile is the desired minimum distance from the weapon.

Section III. FUZES

4-12. General

An artillery fuze is a mechanical device used with a projectile to cause it to function as required.

4-13. Classification

a. Fuzes are classified according to their position on the projectile and method of functioning. Examples include base-detonating (BD) (fig. P18), point-initiating base-detonating (PIBD) (fig. P19), and point-detonating (PD) (fig. 4-20) fuzes. They are classified according to method of functioning as impact, time, proximity, or a combination of these.

(1) *Impact fuzes* (fig. 4-21) are classified by type of action as superquick, delay or nondelay. The superquick fuze functions immediately upon impact with the target. The nondelay type represents the fastest action possible for the inertia type fuze. This type of fuze is inherently slower than the superquick, since its action depends on deceleration during penetration of the target. Delay time of delay fuzes ranges from 0.025 to 0.05 second after impact. (On time fuzes, the time refers to the length of time between the firing of the weapon and the functioning of the fuze.)

(2) There are three types of time fuzes: powder train, mechanical and proximity. Powder train fuzes (fig. 4-22) make use of compressed black powder rings that burn for a predetermined length of time and then initiate the high-explosive element in the fuze. Mechanical time fuzes (fig. P23) incorporate a clock-like mechanism. Through a gear train and escapement, this mechanism trips a firing pin at a predetermined time, causing the fuze to function. Proximity fuzes are discussed in (3), below.

(3) The proximity (VT) fuze (fig. 4-24) is essentially a self-powered radio transmitting and receiving unit. Shortly after the projectile leaves the muzzle of the weapon, the fuze becomes armed and begins sending out radio waves. As the projectile approaches an object, the waves are reflected and picked up by a receiving unit in the fuze. Interaction of the outgoing and incoming waves results in beats. When the beats reach a predetermined intensity, an electronic switch is tripped, thereby closing an electric circuit. An electric charge is permitted to flow through an electric firing squib thus initiating the explosive train. Newer type proximity fuzes are designed for bracket arming for anti-aircraft artillery use and adjustable delay arming for field artillery use.

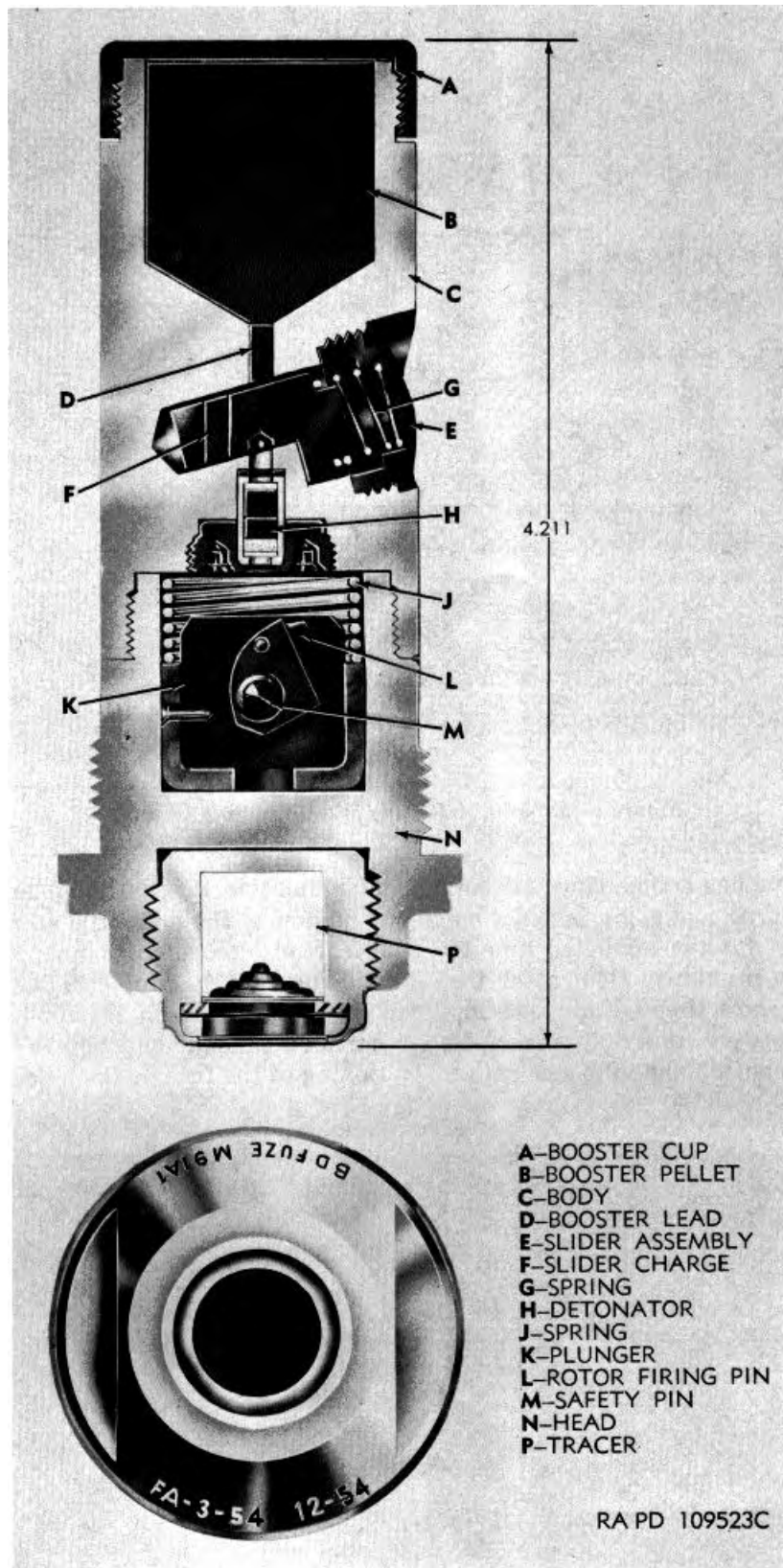

Figure 4-18. Base-detonating fuze.

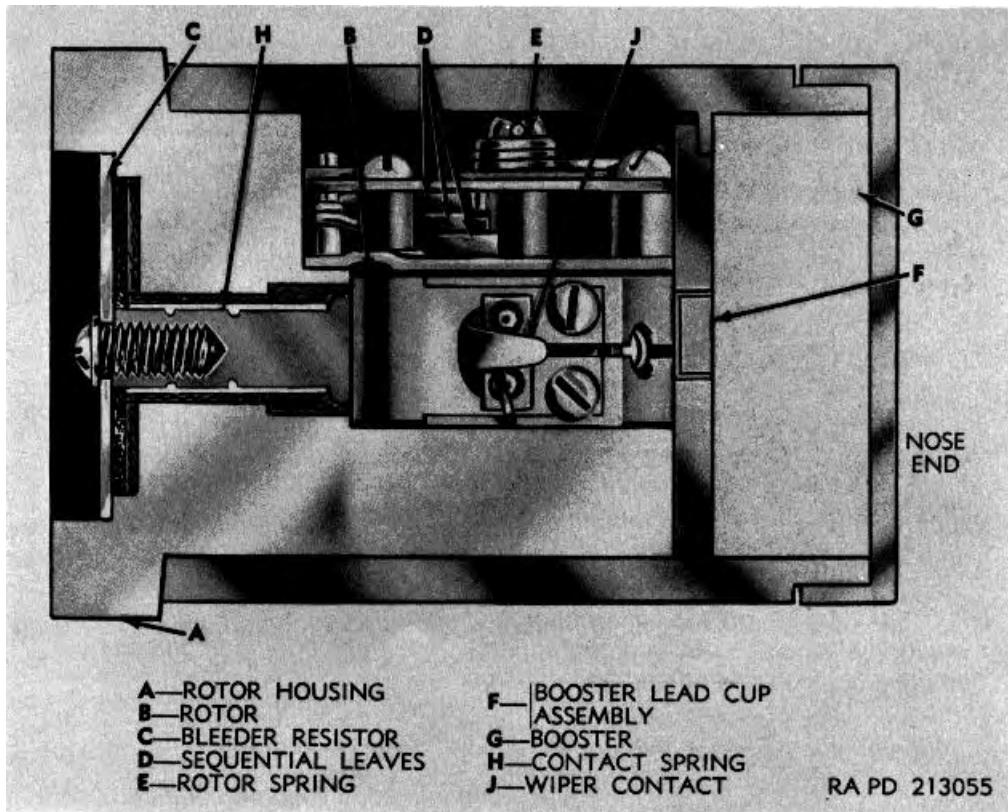

Figure 4-19. Point-initiating base-detonating fuze.

The bracket-arming type has a time ring; the adjustable-delay-arming type has a graduated time scale which must be set for the predicted time to target. When fired, the proximity element of the fuze becomes armed a short time before reaching target and functions on proximity approach. If the fuze does not come within the influence range

of a suitable target, the fuze will cause self-destruction of the projectile soon after the set time. The fuze also contains an impact element. This will function the projectile if impact with a resistant object occurs at any time after arming of the impact element, but before arming and functioning of the fuze by the proximity element.

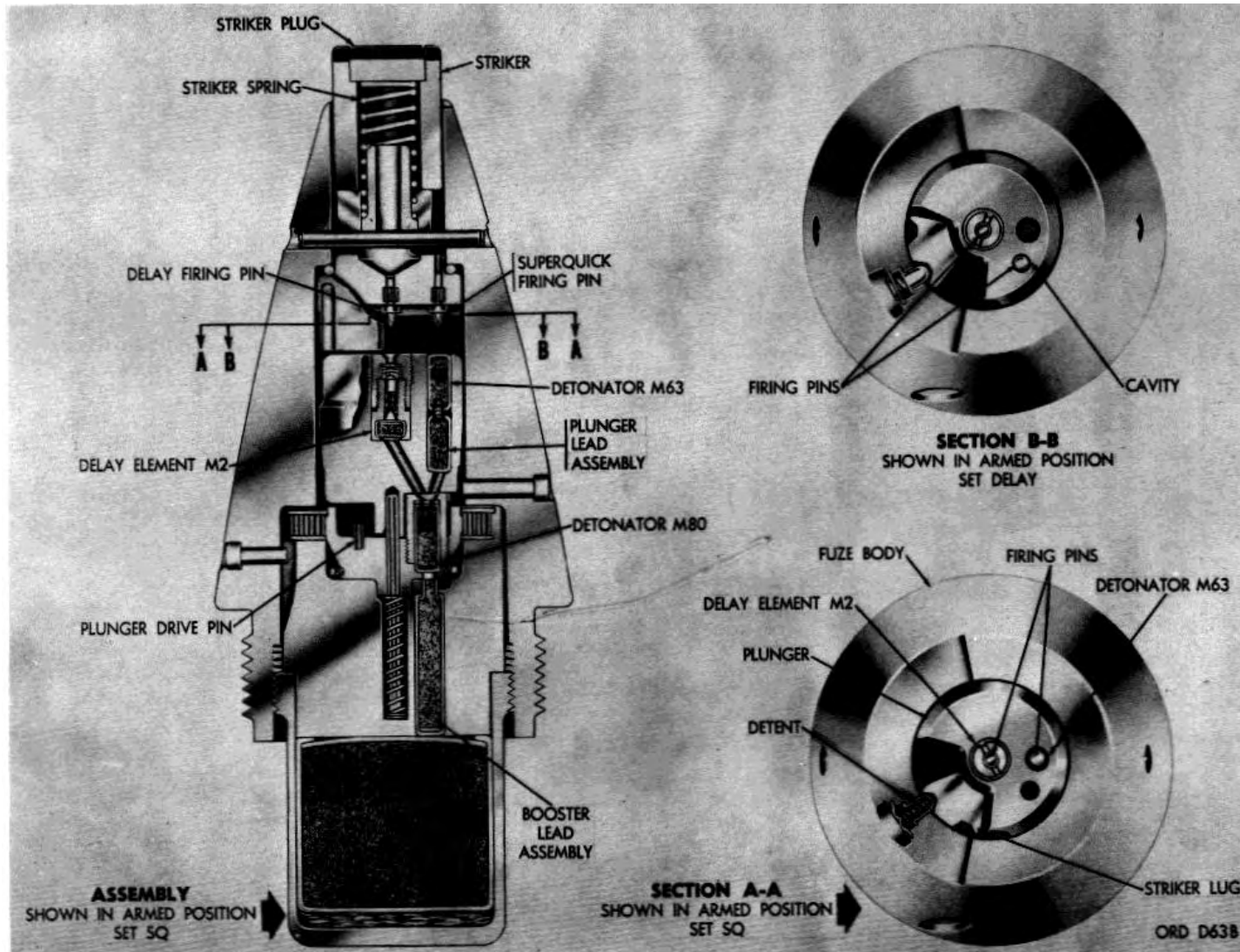

Figure 4-20. Point-detonating fuze.

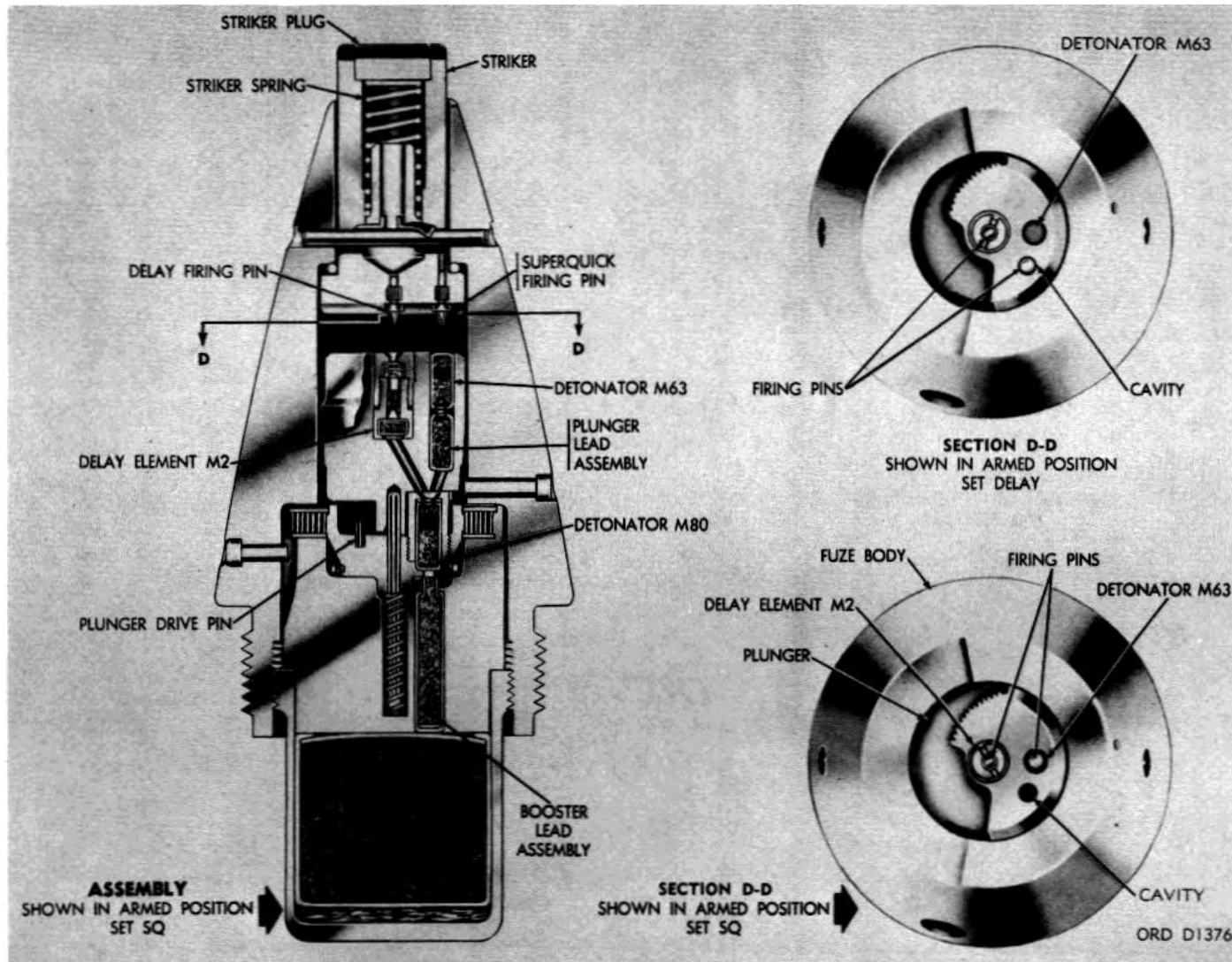

Figure 4-21. Impact fuze.

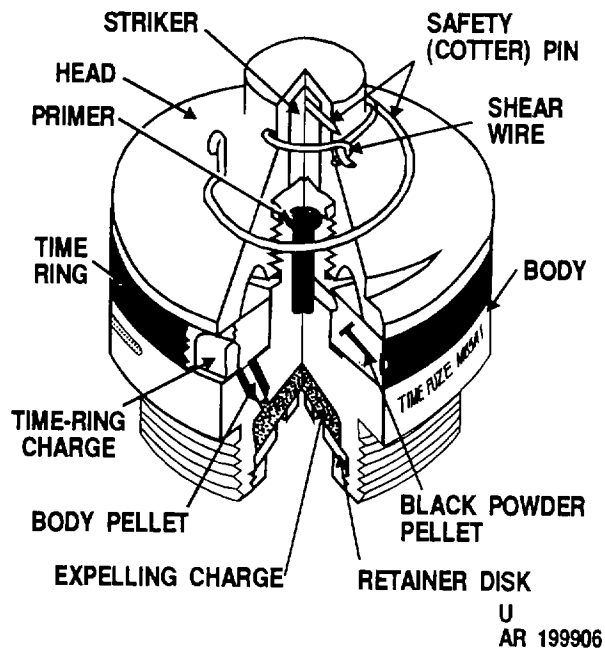

Figure 4-22. Time fuze, powder train.

(4) The concrete-piercing (CP) fuze (fig. 25) is a special, point-detonating impact type assembled to HE projectiles. This type fuze is used against highly resistant targets.

b. Because of their standard contour and equal weight, many PD fuzes are interchangeable and can be employed with several types of projectiles. See TM 43-0001-28 for fuze interchangeability.

4-14. Safety Features

a. Safety wires, cotter pins and other devices are used to hold internal fuze components in an unarmed position and to prevent accidental arming of the fuze before the projectile has left the weapon.

b. In some fuzes, bore safety is provided by interrupting the explosive train. Interruption is generally provided by out-of-line components, or interrupter blocks or sliders, which prevent functioning while the projectile is still in the bore of the weapon.

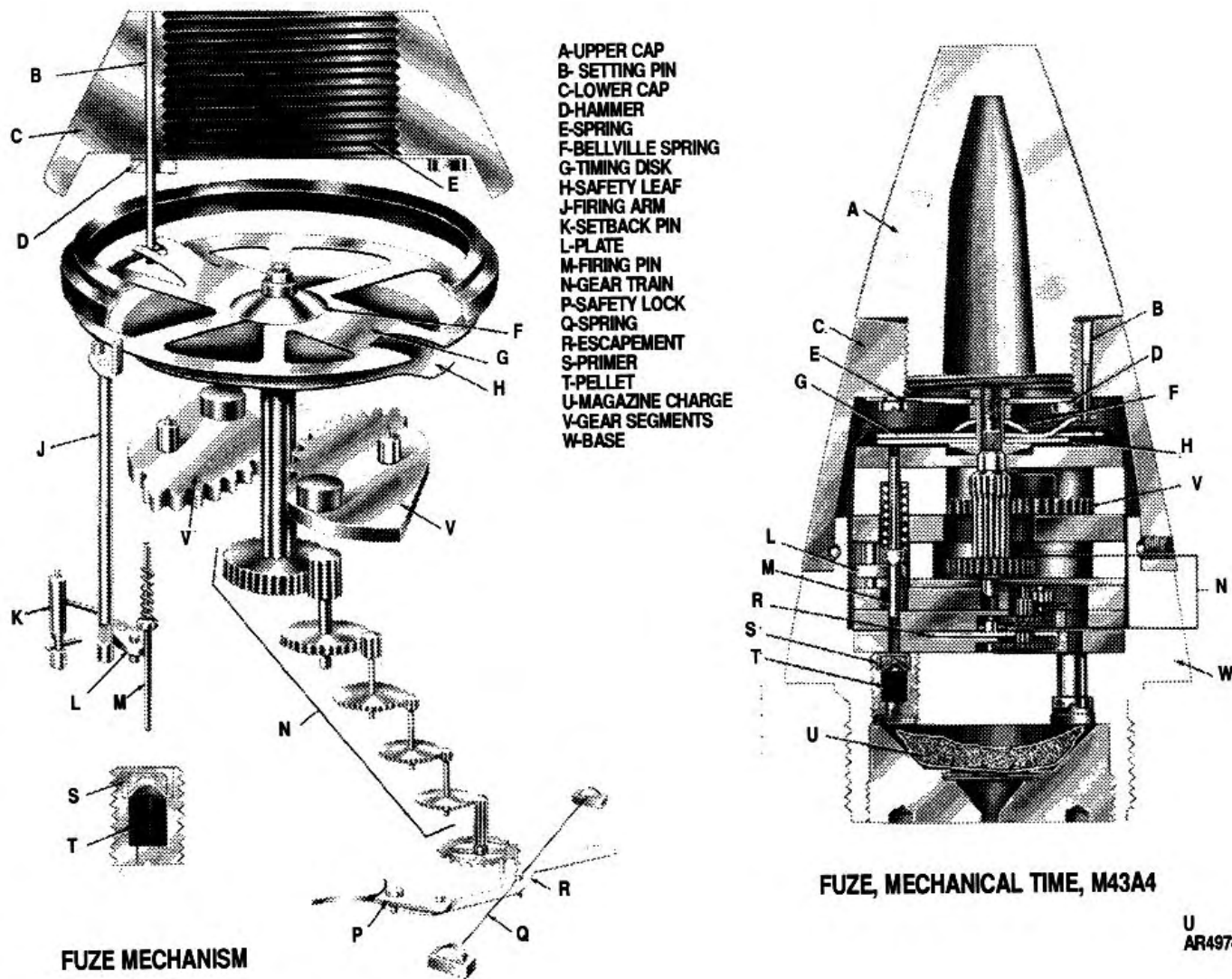

Figure 4-23. Time fuze, gear train

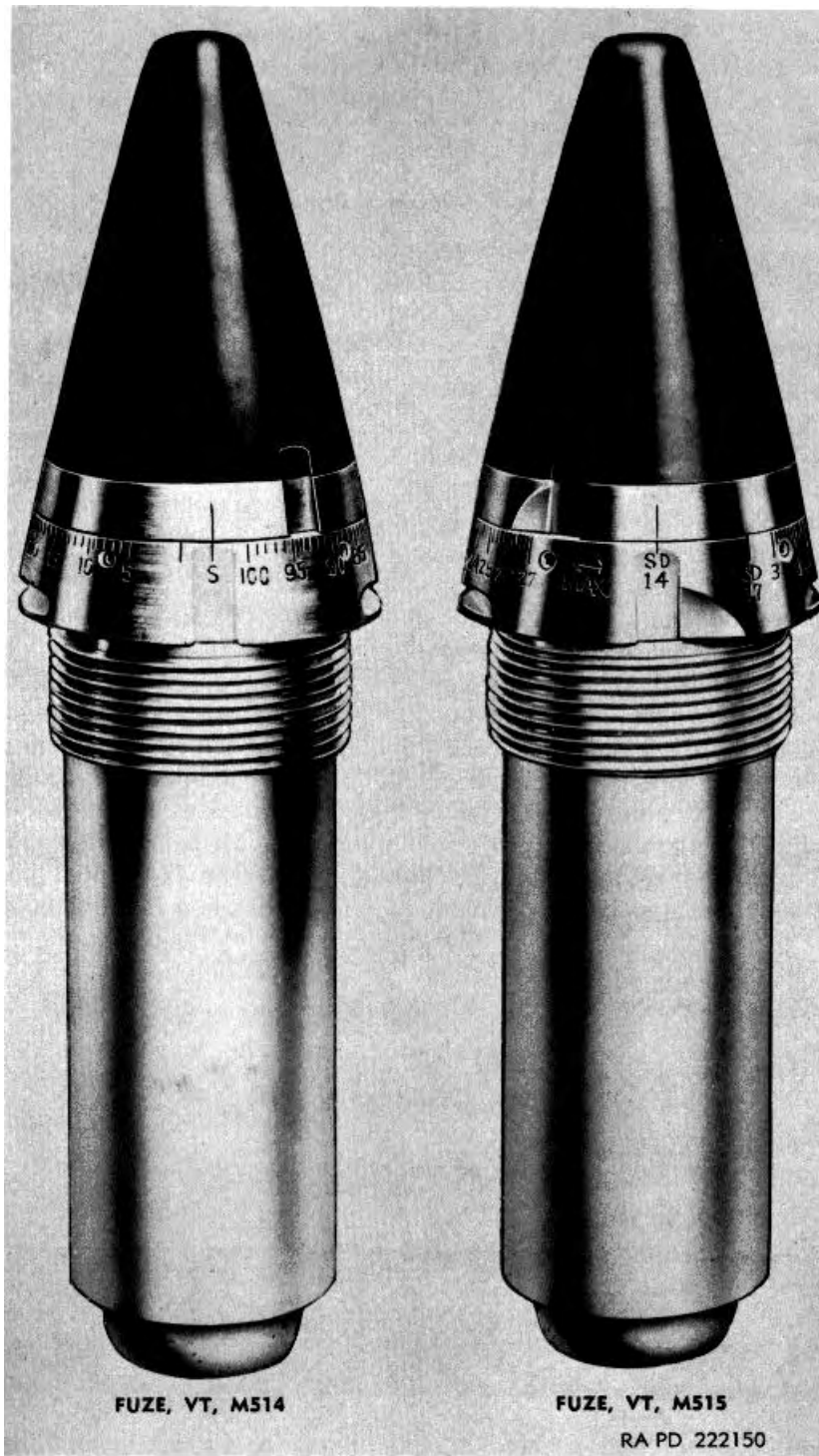

Figure 4-24. Proximity fuzes.

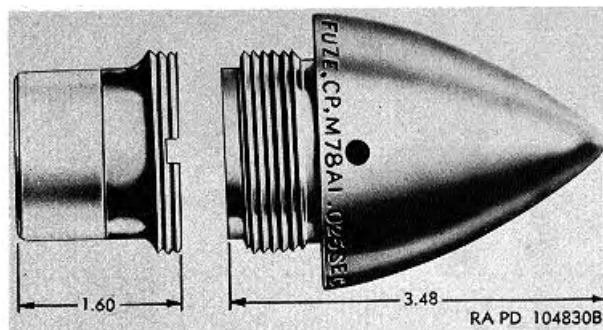

Figure 4-25. Concrete-piercing fuze.

Section IV. PRACTICE, DUMMY, BLANK AND SUBCALIBER AMMUNITION

4-15. Practice Ammunition

a. *General.* Target practice rounds (fig. P26) of fixed, semifixed and separated ammunition are used for training in marksmanship. The rounds have the same weight and contour as the service rounds they simulate. Moreover, since practice ammunition is fired at practice targets, the rounds may be fuzed and have the same propelling charges as the service rounds they simulate. Because they have fuzes and live propelling charges, practice rounds must be handled as carefully as service ammunition. Thus, where indicated by firing table titles, the same firing data are used for firing practice rounds as are used in firing their service counterparts. Some practice projectiles are cast iron while others are service projectiles loaded with sand or other inert material. Certain practice projectiles contain a black powder spotting charge that emits a smoke puff to simulate functioning and to assist in spotting. Target practice

projectiles for mortars (fig. 4-27) contain a black powder charge, propellant, ignition cartridge, and percussion primer. However, training projectiles for mortars have an inert body and no propellant as such, being propelled only by an ignition cartridge.

b. *Identification.*

CAUTION

In some older fixed or semifixed practice rounds, inert projectiles were inadvertently painted black, even though cartridge case contained live propellant (explosive). In handling any round in which projectile is painted black, whether or not marked INERT, be sure to note complete

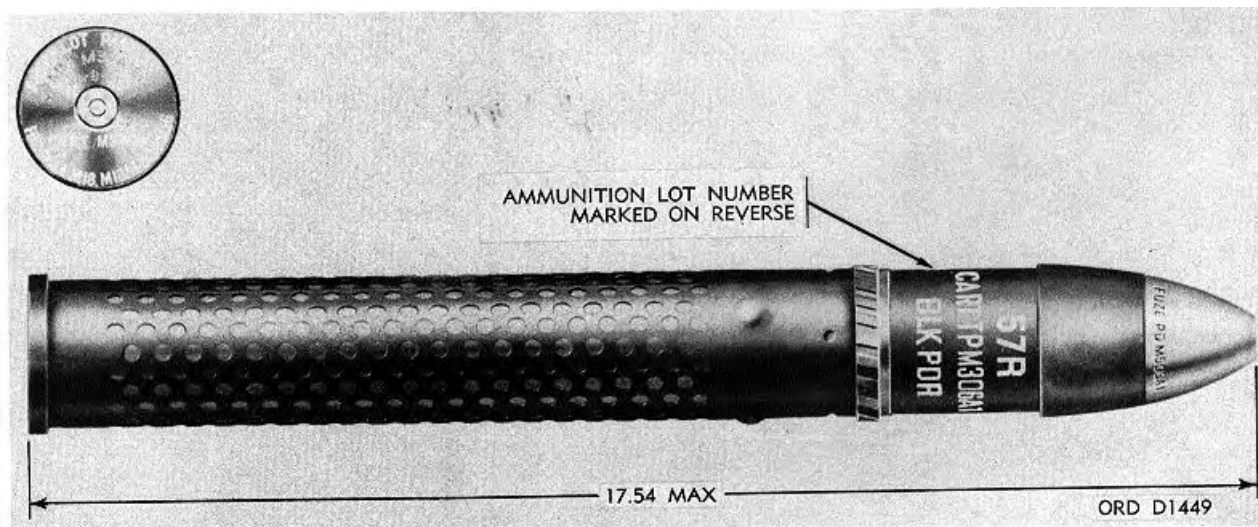

Figure 4-26. Recoilless rifle, target practice cartridge.

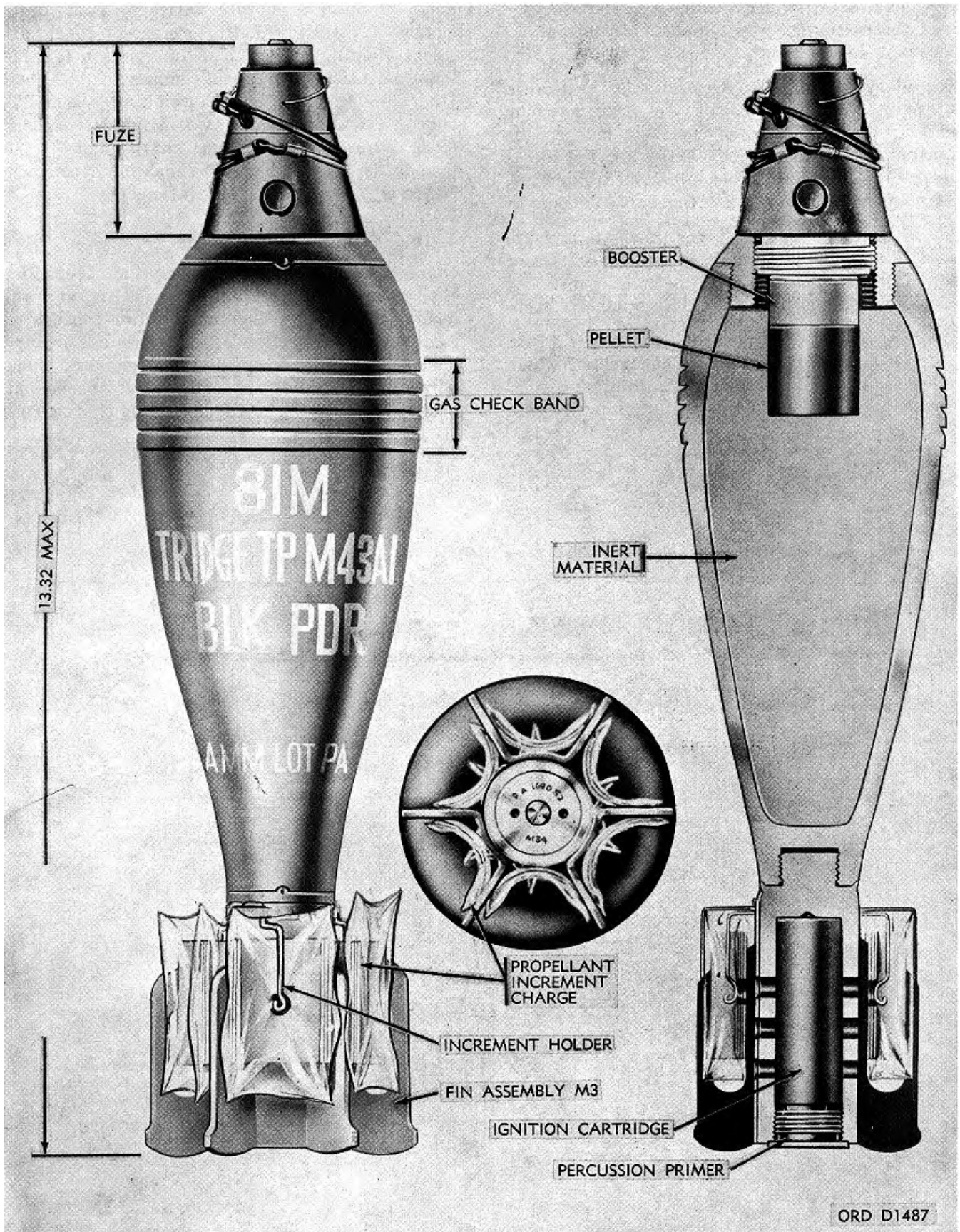

Figure 4-27. Mortar target practice cartridge.

identifying marking of round and whether or not any components contain explosive.

For identification purposes, practice projectiles are painted blue with marking in white. The blue signifies that the round, of which the projectile is a component, is for target practice and includes a propelling charge or other prescribed explosive. See chapter 1 for marking of inert ammunition.

c. *Simulators.* Several types of simulators are used in artillery training to create the effects of actual battle. Considered pyrotechnic items, they are described and illustrated with other pyrotechnic items in chapter 9.

d. *Field Artillery Trainer.* This trainer, which is used in preliminary artillery training, is a compressed air unit consisting of a miniature gun mounted on a

miniature carriage. Four units mounted on a firing platform make up a field artillery training battery. The ammunition for this trainer consists of a 1-inch, commercial, steel ball (the simulated projectile) weighing about 21/3 ounces, and air pressures (which simulate a semifixed, adjustable propelling charge) up to 80 pounds per square inch. The maximum range is 85 yards at 800-mil (45°) elevation.

4-16. Dummy Ammunition

Dummy cartridges, projectiles and propelling charges are used for training in loading and unloading of weapons. Such ammunition consists of completely inert replicas of service rounds or components. Dummy propelling charges are filled with wood grains simulating live propellant grains, and the color of the propelling charge bags

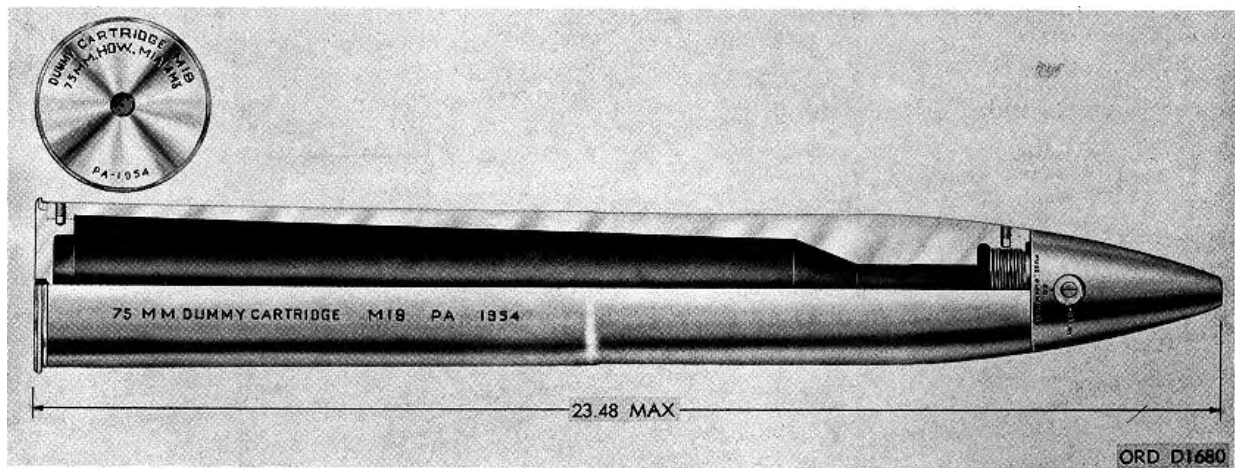

Figure 4-34. Dummy cartridge.

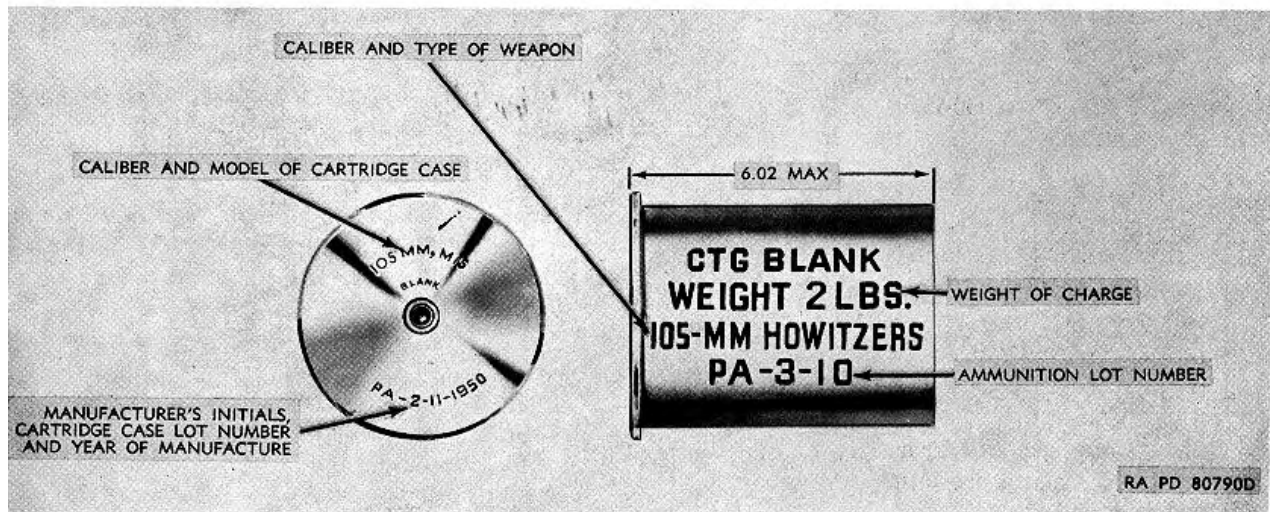

Figure 4-35. Blank cartridge.

is the same as that of service charges. Otherwise, color is not significant. Representative ammunition of this type is shown in figure 4-34. As dummy ammunition is completely inert, no special safety precautions are necessary.

4-17. Subcaliber Ammunition

a. General. Subcaliber guns are auxiliary devices used with tactical weapons during training and practice. Bore wear in the larger caliber weapons is reduced by training with smaller caliber weapons firing smaller caliber ammunition at shorter ranges. Subcaliber guns are designed for interior mounting (inside the bore of the weapon) or exterior mounting (on top of the gun tube). Interior-type subcaliber guns are used with 75mm howitzers, 76-mm guns, 90-mm guns and 105-mm howitzers. External-type subcaliber guns are used with 155-mm guns and howitzers and 8-inch howitzers. Special subcaliber equipment is designed for 4.2-inch mortars.

Figure 4-28. Deleted.

Figure 4-29. Deleted.

Figure 4-30. Deleted.

Figure 4-31. Deleted.

b. Ammunition. Small arms cartridges are used as subcaliber ammunition in small artillery weapons. Medium and large caliber weapons use either 37-mm HE cartridges with black powder substituted for the HE charge or 75-mm service cartridges.

Section V. PRECAUTIONS

4-19. Precautions in Handling

a. General. For applicability of general precautions in handling explosives and ammunition, see chapter 1. In the same connection, see also TM 43-0001-28, TM 9-1300-206 and appropriate weapons manuals.

b. Projectiles.

(1) Inspect projectiles periodically, particularly under conditions of abnormally higher temperature and moisture.

(2) Because projectiles contain high explosives, check for exudation.

(3) Check for gas leaks, which can cause injury to personnel.

(4) Keep illuminants from coming in contact with moisture. They are particularly hygroscopic and subject to deterioration.

c. Propelling Charges.

NOTE

The same precautions are observed in firing subcaliber ammunition as in firing service and practice rounds.

4-18. Blank Ammunition

a. General. Blank ammunition is used for a limited type of artillery firing practice, for maneuvers, for firing the morning and evening gun and for saluting. A representative type of blank ammunition is shown in figure 4-35.

b. Complete Round. A complete round of blank ammunition consists of a cartridge case, primer, black powder charge and a closing cup secured in the mouth of the case. The primer is fitted to the cartridge case as in fixed or semifixed rounds of service ammunition. Weight of the black powder charge varies from 0.87 to 2.0 pounds depending upon caliber and type of round. The blank cartridge contains no projectile.

Figure 4-32. Deleted.

Figure 4-33. Deleted.

c. Charge. The black powder charge for blank rounds consists of loose potassium or sodium nitrate black powder in cotton cloth bags.

(1) Protect propelling charges of all types from moisture.

(2) Examine separate-loading propelling charges at appropriate times.

(3) Check propelling charge bag for discoloration. This usually indicates propellant deterioration.

d. Cartridge Case.

CAUTION

Cartridge cases composed of lightweight brass or steel or felted nitrocellulose are easily damaged.

(1) Inspect packages (inner containers) and packings (shipping boxes) periodically for evidence of damage that might indicate corroded, deformed or ruptured cases.

(2) To prevent serious damage to weapon, do not use cartridges with damaged cases.

(3) Protect felted nitrocellulose cases, which are nonmetallic, from such sources of ignition as smoldering residue, lighted cigarettes or open flame.

e. Fuzes.

CAUTION

Do not disassemble any fuze at any time without specific instructions from the Army Materiel Command.

Handle fuzes carefully. They contain small amounts of sensitive high explosives, such as mercury fulminate, lead azide and lead styphnate.

f. Primers.

(1) Primers contain black powder which is particularly hygroscopic. Inspect periodically for evidence of corrosion.

(2) Keep fuzes and primers in hermetically sealed containers.

4-20. Precautions in Firing

For general precautions and regulations in firing ammunition, see TM 43-0001-28 and AR 385-63.

a. Inspect ammunition prior to firing. Assure that it is clean and free of dents or corrosion.

b. Do not use ammunition with serious dents, burrs or other defects. Firing such ammunition may result in serious blowback or malfunction.

c. Protect semifixed propelling charges (such as howitzer or mortar increments), which are exposed briefly to weather during preparation for firing, against moisture and extreme temperatures. Assure that charges are clean and undamaged.

d. Remove and discard U-shaped packing stop before attempting to load round into weapon.

e. Do not remove certain separately issued fuzes, such as proximity fuzes which are assembled in field to

90-mm, 105-mm and 120-mm separate-loading projectiles and mortar rounds, from their hermetically sealed containers until just prior to use. When screwing fuze into projectile, tighten with appropriate fuze wrench and set, when required, with appropriate fuze setter.

f. Handle complete rounds, particularly rounds with fuzes, with care at all times. Explosive elements in fuzes and primers are particularly sensitive to shock and high temperature.

g. Remove safety wire from fuze just before firing and at no other time.

h. Drop mortar rounds, fin end first, into muzzle of mortar, with bore-riding pin in place. When cartridge is released to slide down barrel, remove hands instantly from muzzle.

i. To prevent accidental detonation of highly sensitive primer, be especially careful in handling all rounds employing cartridge case with base-affixed primer.

j. Do not break moisture-resistant seal on fiber container until ammunition is to be used.

k. Do not handle or move duds. Their fuzes may be armed. Destroy duds in place in accordance with TM 9-1300-206.

l. Take following precautions with cartridges containing electric primers: (1) Do not have rounds in gun chamber when electric leads are exposed.

(2) Check for conditions conducive to static charge buildup. Static charges can be produced when personnel wear furs or clothing of wool or synthetic fibers.

(3) Assure that aircraft are electrically grounded during ammunition loading operations.

Section VI. PACKING AND MARKING

4-21. Packing

a. Fixed, semifixed and separated artillery ammunition items are packed in moisture-resistant fiber containers overpacked in wooden boxes. (See fig. 4-30 and illustrations in chapter 1.) Crates may be used for additional protection for certain propelling charges, for projectiles with windshields, and for dummy projectiles.

b. Some fuzes and primers may be packed in hermetically sealed cans overpacked in wooden or metal boxes.

c. Separate-loading projectiles are usually shipped palletized. A grommet is used to protect the rotating band and an eyebolt-lifting plug is threaded in the fuze hole. Airtight steel containers are used to pack separate-loading propelling charges. In packings of recent design, a primer is packed in the container with each propelling charge.

d. Except for training ammunition, which may be requisitioned by components, mortar ammunition is packed as complete rounds. Each round is packed in a metal container or wooden packing box. Jungle wrap is used on certain rounds as additional protection.

4-22. Marking

Representative markings on ammunition items and packing boxes are discussed and illustrated in chapter 1.

Figure 4-36. Deleted.

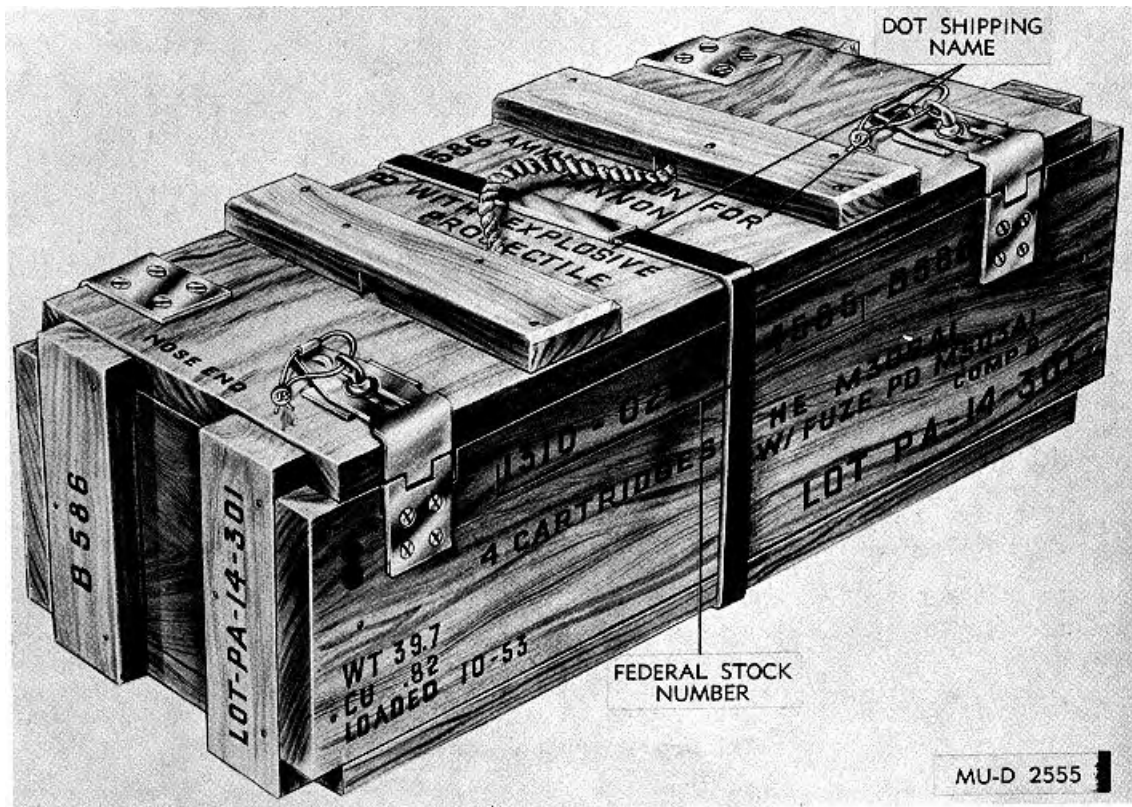

Figure 4-37. Typical wooden packing box.

This page intentionally left blank.

CHAPTER 5 ROCKETS

Section I. INTRODUCTION

5-1. General

a. A rocket is a missile propelled by a discharging jet of gas. The gas is produced by the burning of a propelling charge within the rocket. Military rockets are distinguished from guided missiles, which are similarly propelled. by the fact that the trajectory of a rocket cannot be guided or controlled in flight.

b. A military rocket consists essentially of a head, a fuze and a motor. The head contains the element required to produce the desired effect at the target, usually an explosive or chemical filler. The fuze initiates the functioning of the filler at the time and under the circumstances desired. The motor propels the rocket to the target, and includes the propelling charge, the nozzle (or nozzles) and means of igniting the propellant. The rocket is stabilized in flight by fins, attached to the motor, or rotation (spin).

c. A rocket launcher is employed to aim the rocket along a definite trajectory.

5-2. Application

a. Because rocket launchers are generally light and portable, rockets can be fired from aircraft and from ground areas inaccessible to conventional artillery.

b. Used in applications similar to conventional artillery, rockets complement artillery by extending the area covered and the types of targets that can be engaged. The forces of setback are relatively small, but provide a comparatively long period of acceleration. This permits the use of light-case projectiles of higher capacity and less expensive construction than equivalent artillery projectiles. Rockets also use fuzes of lighter construction than those required for artillery.

c. Rockets are relatively inexpensive, easily launched, and economical in the use of personnel. However, they have the disadvantage of requiring the protection of operating personnel and flammable material from backblast.

d. For detailed information on rockets, see TM 9-1950.

5-3. Principles of Rocket Propulsion

a. Gas under pressure in a closed container exerts pressure equally in all directions (A, fig. 5-1); therefore, no movement of the container will occur.

b. When a hole is made in one end of the container (B, fig. 5-1), the pressurized gas flows out, since the atmosphere is at a lower pressure. Because the hole reduces the area over which the pressure acts, the total force acting on the end with the hole is less than the total force acting on the closed end. For this reason, the container will move in the opposite direction of the escaping gas. It is not only the escaping gas pushing on the air which provides thrust, but also the force of the pressure exerted on the closed end of the motor.

c. The overall efficiency of the rocket motor is increased by the addition of the nozzle (C, fig. 5-1), which reduces friction and controls the expansion of gas.

5-4. Classification

a. *General.* Rockets are classified basically as shoulder-fired, ground-to-ground or aircraft (air-to-air or air-to-ground).

b. *Use.* Rockets are classified according to use as service, practice, drill, or subcaliber. Service rockets are used for effect in combat; practice rockets, for training and target practice; and drill rockets, for training in handling. subcaliber rockets are smaller rockets designed for practice purposes. For reasons of economy, subcaliber rockets are fired from standard launchers with a subcaliber launcher inserted in the bore.

c. *Filler.* Rockets are classified according to filler as antipersonnel, high-explosive, chemical, smoke, spotting and practice.

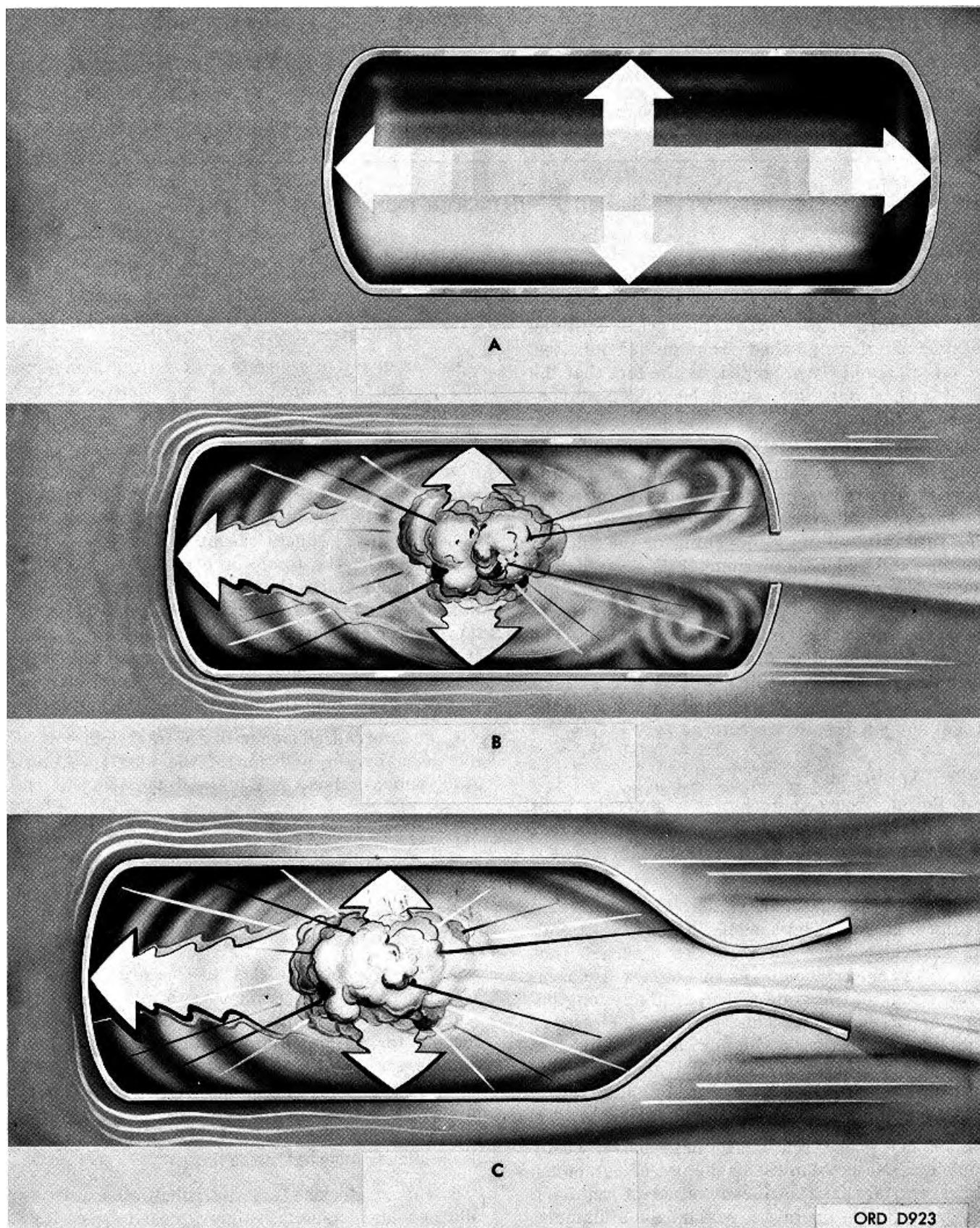

Figure 5-1. Principles of rocket propulsion.

(1) *Antipersonnel* rockets contain a filler of fin-stabilized steel fragments called flechettes. They are employed against enemy personnel and light materiel.

(2) *High-explosive* rockets contain a filler of high explosive for blast, fragmentation, mining or demolition effect. The high-explosive antitank (HEAT) rocket, which contains a filler consisting of a shaped charge of Composition B or other high explosive, is used for penetration of armored targets.

(3) *Chemical* rockets contain a chemical agent and a burster to disperse the agent at the target. The chemical agent may be a gas for producing a toxic or harassing effect, an incendiary or a combination of these.

(4) *Smoke* rockets contain a filler of white phosphorus which produces smoke for screening and signaling.

(5) *Spotting* (red/yellow marker) rockets contain colored dye pellets and are used as target markers.

(6) Generally, *practice* rockets are assembled with completely inert warheads and dummy fuzes. However, warheads for large ground-to-ground practice rockets contain spotting charges and MT fuzes. All practice rockets are assembled with motors which contain the same propelling charge and igniter as the service rocket. Drill rockets, designed for training in service of the piece, are completely inert, both warhead and motor.

Section II. COMPLETE ROUND

5-5. General

A complete round consists of all the components which comprise one rocket. The complete round may be issued as a single assembled unit or as separate components to be assembled in the field.

a. The motor, which propels the rocket, contains the propelling charge and the igniter and is assembled to the rear of the warhead or base-detonating fuze. It consists of a tube closed at the forward end with one or more nozzles at the rear end. The propelling charge, in stick form, is held in place by a trap, grid, or cage. Contact rings, fixed connections to fin shrouds, or cable and plug, depending on design of the launcher, electrically connect the igniter to the external firing circuit.

b. The warhead is that component which contains the high-explosive charge or other filler, the booster, and the fuze. Its purpose is to produce the desired effect at the target.

5-6. Explosive Train

The large quantities of explosives in warheads and motors must be comparatively insensitive to permit safe handling in storage and transit. Yet, means of initiating these explosives at the desired time must be dependable.

a. *High-Explosive Train.* Sensitive explosives that can be detonated by impact of a firing pin or by electrical means are safe to handle in small quantities, highly compressed and enclosed in a capsule. They are used in fuze primers, detonators and squibs. Since the small flame from a primer, detonator or squib will not properly detonate a large charge of comparatively insensitive explosive, it is necessary to interpose a booster between the initiating element and the main high explosive charge. Such an arrangement is called a high-explosive train. This train, which is in the warhead, consists essentially of a primer, detonator or squib, and a booster and the high-explosive charge. A delay element sometimes is incorporated in the fuze to meet requirements for delay action.

b. *Propellant Explosive Train.* Sensitive explosives that can be detonated by electrical means are safe to handle when in small quantities, highly compressed and enclosed in a capsule. They are used in electric squibs. Since the small spit of flame from an electric squib will not properly ignite a large charge of comparatively insensitive propellant, it is necessary to interpose an igniter between the initiating element and the propellant. Such an arrangement is called a propellant explosive train. This train, which is in the motor, consists essentially of an electric squib, igniter (black powder) and the propellant charge.

Section III. WARHEAD

5-7. Flechette

The flechette warhead consists of a plastic and metal nose cone, an extruded aluminum body loaded with 20-

grain steel flechettes, and an integral base-detonating fuze.

5-8. High Explosive

Some high-explosive warheads are of thin-walled construction for maximum capacity of explosive and blast effect; some have heavy walls to permit penetration of light armor before exploding; and others have medium thick walls to provide a maximum number of effective fragments. Point-detonating, base-detonating and proximity fuzes are used with HE warheads.

5-9. High-Explosive Antitank (HEAT)

HEAT warheads, containing a shaped charge of high explosive, are designed to penetrate armor and other highly resistant targets. Current production models are assembled with point-initiating, base-detonating fuzes which function faster and assure greater penetration than the inertia type base-detonating fuzes used in older warheads.

5-10. Chemical and Smoke

Chemical warheads usually have thin walls, and contain a filler of casualty or harassing gas. They use point-

detonating, base-detonating or mechanical time fuzes, with a burster well extending along the axis of the warhead from the fuze seat. Smoke warheads, similar to chemical in construction, contain a filler of white phosphorus.

5-11. Spotting (Red/Yellow Marker)

Spotting warheads are assembled from metal parts originally designed for high-explosive warheads. This type of warhead is fitted with a point-detonating fuze and loaded with a baratol burster, a tetryl pellet and red or yellow dye pellets.

5-12. Practice

The 762-mm practice warhead contains a spotting charge and is fitted with a mechanical time fuze. All other practice heads are completely inert. They consist of high-explosive warhead metal parts loaded with inert material or specially designed metal parts which simulate the weight and configuration of service warheads. They may be fuzed with inert or dummy fuzes, or unfuzed.

Section IV. MOTOR

5-13. General

a. A motor, which propels the rocket, is assembled to the rear of the warhead or base-

detonating fuze. Generally, the motor consists of the following major components (fig. 5-2):

- (1) Motor body (combustion chamber)

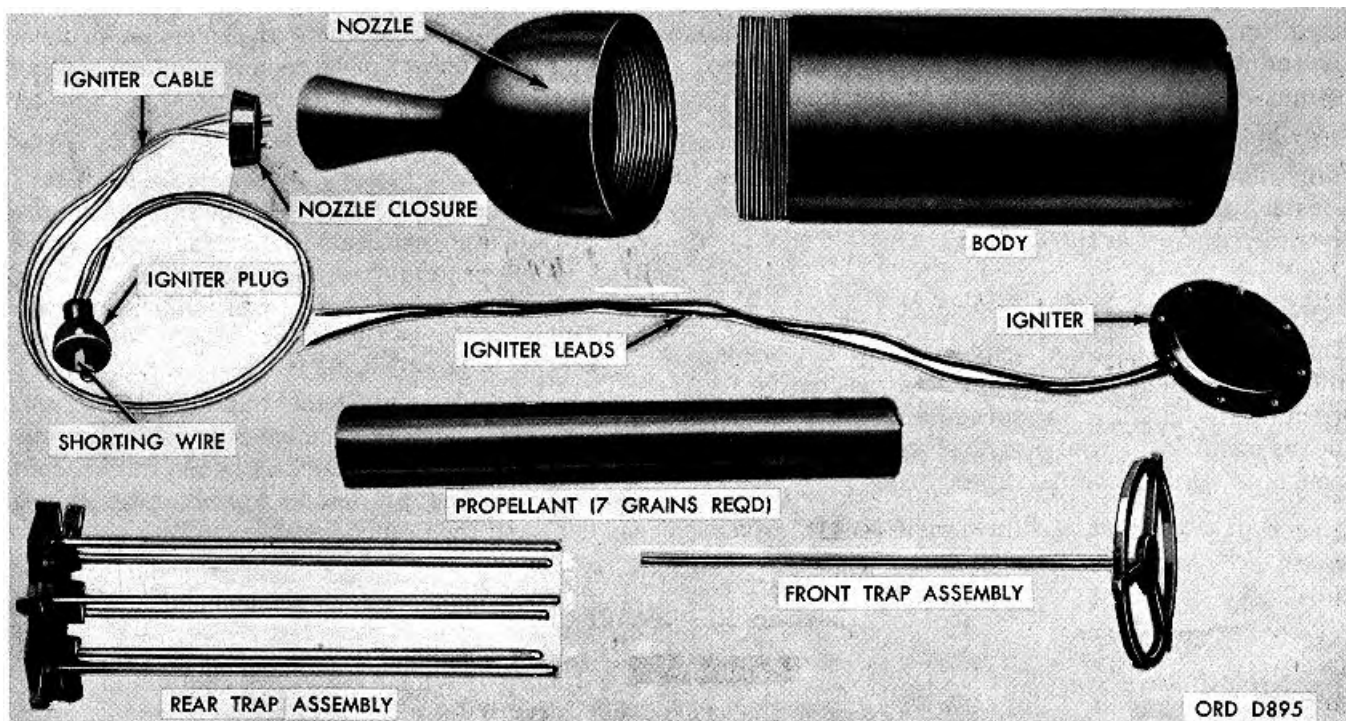

Figure 5-2. Major components of rocket motor.

- (2) Propelling charge
- (3) Igniter assembly
- (4) Nozzle(s)
- (5) Trap assembly (optional)
- (6) Resonance rod assembly (optional)

The base of the motor is constricted to form the throat of one or more nozzles. Flight of the rocket is stabilized by fins attached to the rear of the motor, or by spin of the rocket about its axis. This spin is produced by high-velocity gases passing through canted nozzles in the base of the motor. In some larger motors, an assembly of spin rockets provides the initial thrust required to rotate the rocket.

b. The motor body, usually a hollow metal cylinder fitted with a nozzle at the rear, is either closed at the forward end or threaded for assembly with the warhead. The body houses the propelling charge and the igniter assembly.

c. The propelling charge consists of one or more grains of solid propellant, either double-base or composite. Double-base propellant consists principally of nitrocellulose and nitroglycerin. Composite propellant is a mixture of an organic fuel, an inorganic oxidizing agent and a binding agent. To control the burning rate, propellant grains may be coated with sheets of a slower burning inhibitor material. However, if the propellant has center perforated grains, resonance rods running through these perforations serve the same purpose by dampening pressure waves created by the burning propellant.

d. The igniter assembly consists of a charge of black powder housed in a cylindrical plastic container, and one or more electric squibs.

e. The nozzle is convergent-divergent (Venturitype) in shape to eliminate turbulence and to provide a relatively frictionless flow of escaping gas. The throat (constricted portion) of the nozzle may be lined with a refractory substance, such as graphite. This prevents heat of the propellant gases from changing dimensions of the throat. A small change in throat area affects functioning of the motor by altering flow rate and direction of the escaping gases. Nozzles on most rocket motors are canted (scarfed). However, motors used

with highspeed aircraft rockets have straight nozzles. Nozzle closures or seals prevent moisture from entering the motor. In some cases, the closure or seals aid ignition of the propellant by causing pressure to build up within the chamber when the igniter is "fired." Special safety devices (pressure relief valves, etc.) limit pressure and prevent rupture of the chamber.

f. A grid-like trap assembly may be located on the approach side of the nozzle to prevent ejection of unburned portions of the propellant. Some propelling charges are suspended in the motor body in a manner which eliminates the need for a trap.

5-14. Functioning

a. When the propellant in the rocket motor is ignited, pressure in the chamber generally rises within 0.005 to 0.05 second to a maximum value.

This value is determined by the burning rate of the propellant and the diameter of the nozzle orifice. Depending on the design of the propellant grain and the presence of ballistic modifiers, the charge burns at a nearly constant rate. This steady state pressure is maintained constant or decreases (tails off) very slowly until the propellant is completely consumed. Complete consumption takes from a fraction of a second to a minute or more. At very high operating temperatures, the burning of the propellant is usually completed before the rocket leaves the launcher. At low operating temperatures, burning may continue after the rocket is launched and a phenomenon known as afterburning will occur. With all rockets at all temperatures a blast from the rear of the launcher (backblast) occurs.

b. Each type of propellant composition has a critical pressure. Below this pressure, the composition burns nonuniformly and gives erratic ballistic effects. In addition, composite propellant, burning below the critical pressure, burns until it is extinguished by ashes which form on the surface of the grain. When the ashes sluff off, the propellant reignites and the process is repeated, creating an erratic sound pattern called "chuffing." *c.* The critical pressure is also affected by cracks in the propellant grain. Cracks increase the burning surface and, subsequently, the pressure. This can result in an overpressure sufficient to rupture the rocket motor.

Section V. LAUNCHERS

5-15. General

The rocket launcher holds the rocket and provides initial guidance and electric contacts for firing. In some launchers, the source of electricity for ignition is integral with the launcher, as a magneto or batteries; in others, electrical energy is derived from an outside source, such as an aircraft's electrical system.

5-16. Types

a. *Tube.* The launcher proper, as distinct from the mount, consists of a tube or a set of tubes with a means of holding the rocket in place and a mechanism for igniting the rocket motor. Some tube launchers are expendable (c below) ; that is, they are used for only one firing and discarded. This type launcher may be used as the shipping container for the rocket. Single-tube launchers can be fired from the shoulder in standing, kneeling, or sitting position. A bipod and rear

monopod are normally used for firing in a prone position. Multiple-tube launchers consist of a number of tubes in a cluster mounted on a carriage, vehicle, or aircraft.

b. *Rail.* These launchers are equipped with railtype launching beams traversed and elevated to provide guidance and spin to the rockets. Rockets fired from this type of launcher are generally stabilized by a combination of fins and spin.

c. *Expendable.* Typically, an expendable launcher consists of a plastic or metal alloy tube in which the complete rocket is shipped. The launcher is used once and discarded. Some expendable launchers have mounting hardware (tripods, azimuth and elevation adjustment devices, etc.) attached. Shoulder-fired, expendable launchers are complete with sights and firing mechanism.

Section VI. FUZES

5-17. General

A fuze is a device used to function a rocket at the time and under the circumstances desired. Rocket fuzes are classified according to location in the warhead as point detonating (PD), base detonating (BD), or point initiating, base detonating (PIBD). They are classified according to method of functioning as time, proximity, or impact.

5-18. Types

a. *Time* fuzes function a preselected number of seconds after the round is fired. Impact fuzes function upon impact with superquick, delay, or nondelay action.

(1) In the case of *superquick* action, the warhead functions almost instantaneously on impact, initiated by a firing pin driven into a detonator.

(2) In *delay* action fuzes, the warhead functions a fixed time after impact to permit penetration of the target before the warhead explodes. The amount of delay, usually between 0.025 and 0.15 second, depends on the delay element incorporated in the fuze. Arming may be accomplished by mechanical means utilizing gear trains, air stream (air arming), spring action, centrifugal force or inertia, gas pressure (pressure arming), or a combination thereof.

(3) *Nondelay* action, somewhat slower than superquick, occurs in delay-action fuzes when the black

powder normally contained in the delay element has been removed.

b.

CAUTION

Rockets fuzed with proximity fuzes may function prematurely if fired too close to trees or other intervening objects. There should be at least 250 feet clearance from objects short of the target.

The *proximity* fuze detonates the warhead at a distance from the target to produce optimum blast effect. It is essentially a radio transmitting and receiving unit and requires no prior setting or adjustment. Upon firing, after the minimum arming time, the fuze arms and continually emits radio waves. As the rocket approaches the target, the waves are reflected back to the fuze. The reflected waves produce a beat. When received by the fuze with a predetermined intensity, as on approaching close to the target, this beat operates an electronic switch in the fuze. This permits electric current to flow through an electric squib, initiating the explosive train and detonating the rocket. Proximity fuzes for rockets are of two types—one for ground-type rockets, the other for aircraft-type rockets. Proximity fuzes are physically interchangeable with other standard fuzes in ground-type rockets having deep fuze cavities.

c. The *PIBD* fuze detonates the rocket on impact with the target. The fuze consists of a nose assembly and a base assembly connected by a wire passing through a conduit in the rocket head. Pressure of impact on a piezoelectric crystal in the nose assembly generates a surge of electricity. This is transmitted to a low-energy detonator in the base assembly, detonating it. Some *PIBD* fuzes have a graze-sensitive element

which will actuate the fuze if impact does not initiate the piezoelectric crystal.

d. *Boresafe* rocket fuzes are those in which the explosive elements are so separated as to prevent explosion of the warhead before the rocket leaves its launcher. Explosion is prevented even if the more sensitive elements (primer or detonator) should accidentally function.

Section VII. IDENTIFICATION AND PACKING

5-19. Marking and Painting

a. *Marking.* Rockets are identified by standard nomenclature and lot number. Such identification is marked on all containers and, unless the item is too small, on the ammunition itself. Rocket motors are also marked to indicate temperature limits and performance characteristics. Dimensions and weights of packing boxes and other packing and shipping data are marked on the packing box. Packing boxes containing assembled complete rounds are also marked to indicate the nose end of the rocket.

b. *Painting.* In general, rocket motors are painted brown or olive drab. Rockets themselves are color coded to indicate the type of filler. See chapter 1 for color coding.

5-20. Packing

a. Small rockets are packed as assembled rounds in sealed fiber or metal containers overpacked, in quantities of 1 to 25, in wooden boxes (fig. 5-3).

b. Rockets fired from expendable launchers are packed and shipped in the launcher, which constitutes the packing container.

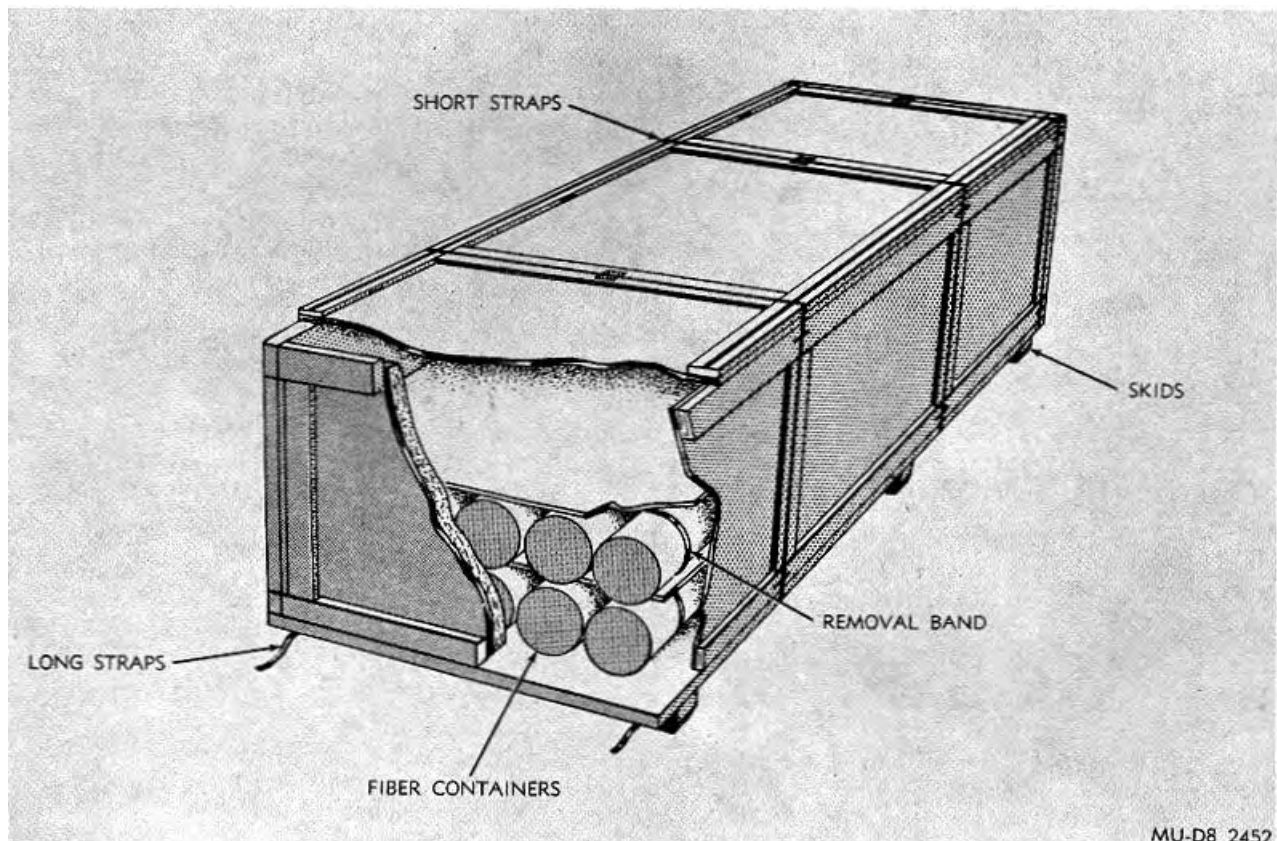

Figure 5-3. Packaging of small complete round rockets.

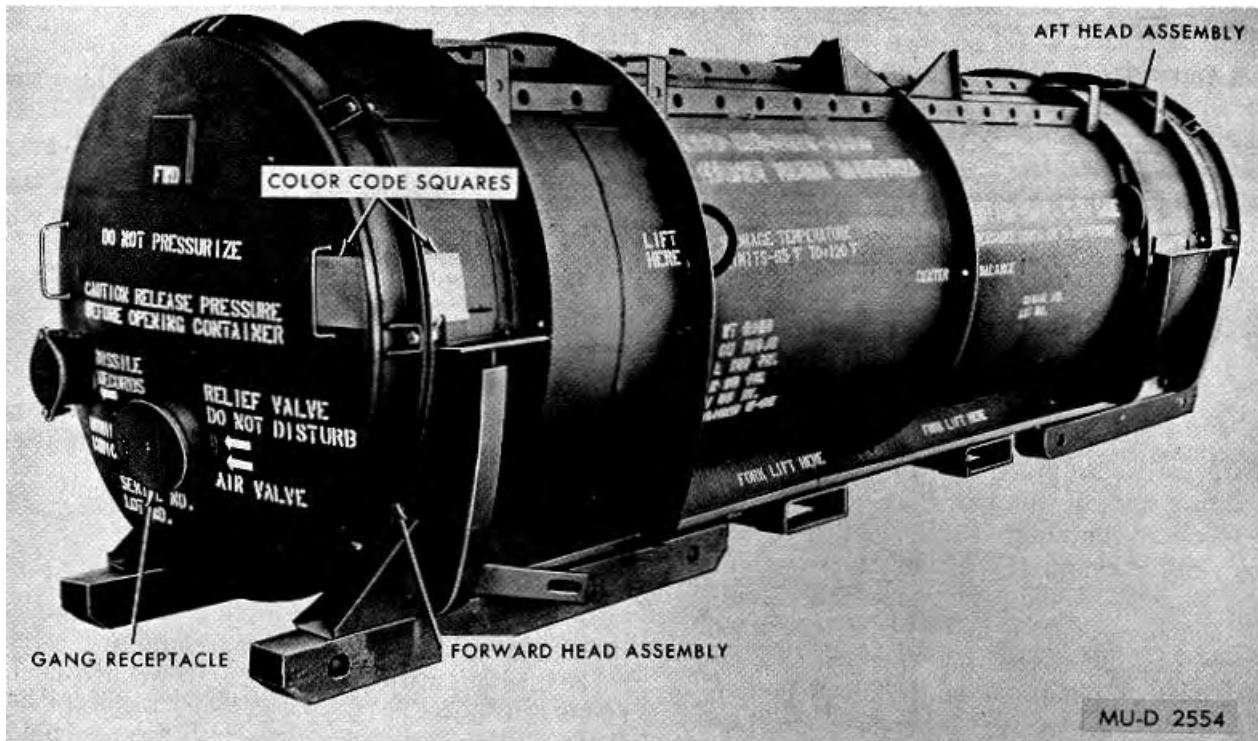

Figure 5-4. Typical rocket motor container for large motors.

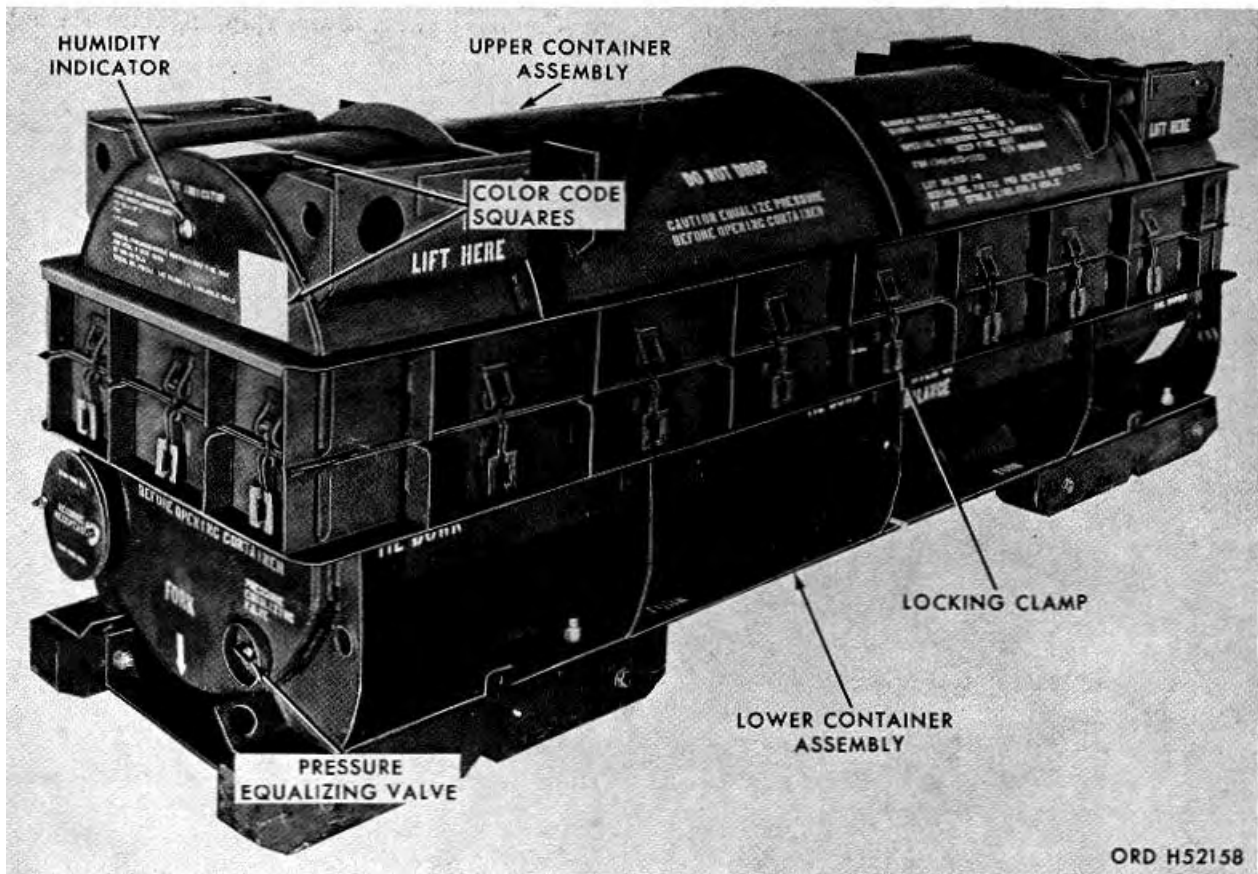

Figure 5-5. Typical warhead container for large warheads.

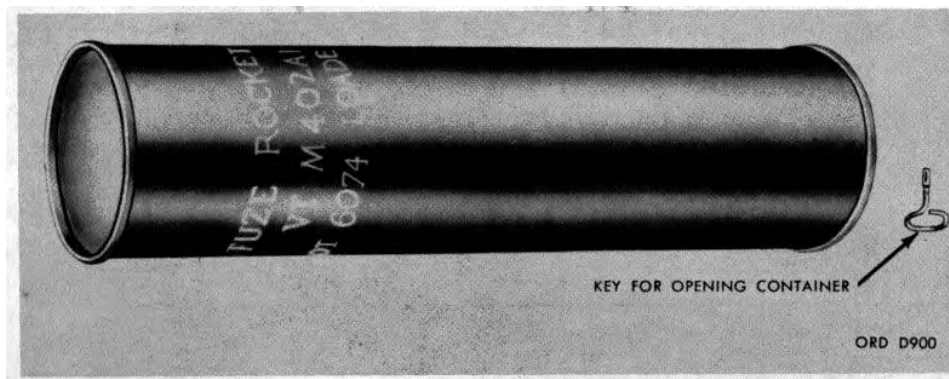

Figure 5-6. Hermetically sealed container for proximity fuze.

c. Large ground-to-ground rockets are shipped unassembled, with the motor (fig. 5-4) and the warhead (fig. 5-5) packed separately.

d. Certain PD fuzes are assembled to rockets. Others are packed separately in hermetically sealed containers or wooden boxes. Some proximity fuzes are packed in hermetically sealed containers (fig. 5-6),

overpacked in metal (fig. 5-7) or wooden (fig. 5-8) packing boxes; others are packed in the same container with the assembled motor and warhead, but are not assembled to the warhead.

e. Complete packing and shipping data are published in SC 1340/IL.

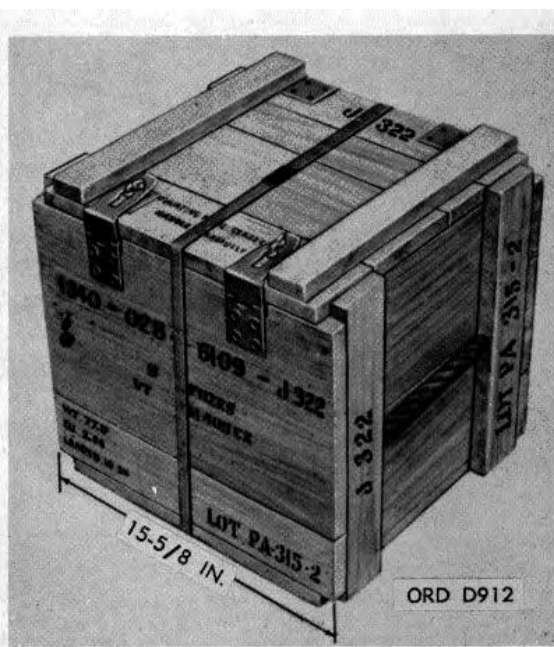
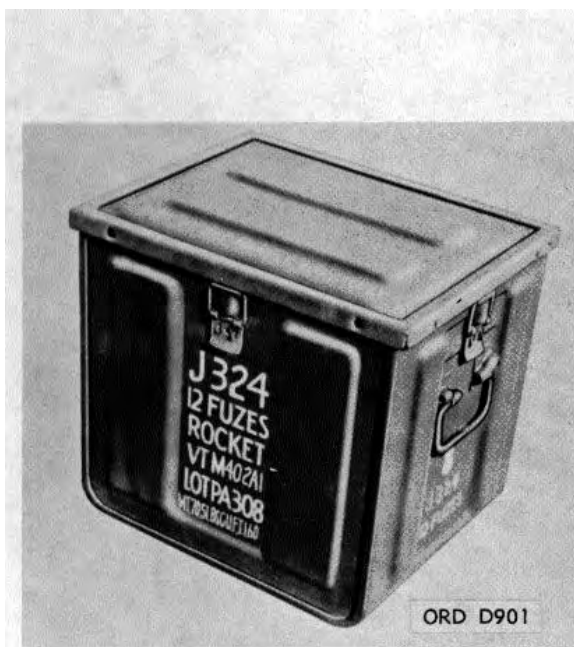

Figure 5-7. Metal container for proximity fuze. Figure 5-8. Wooden packing box for proximity fuze.

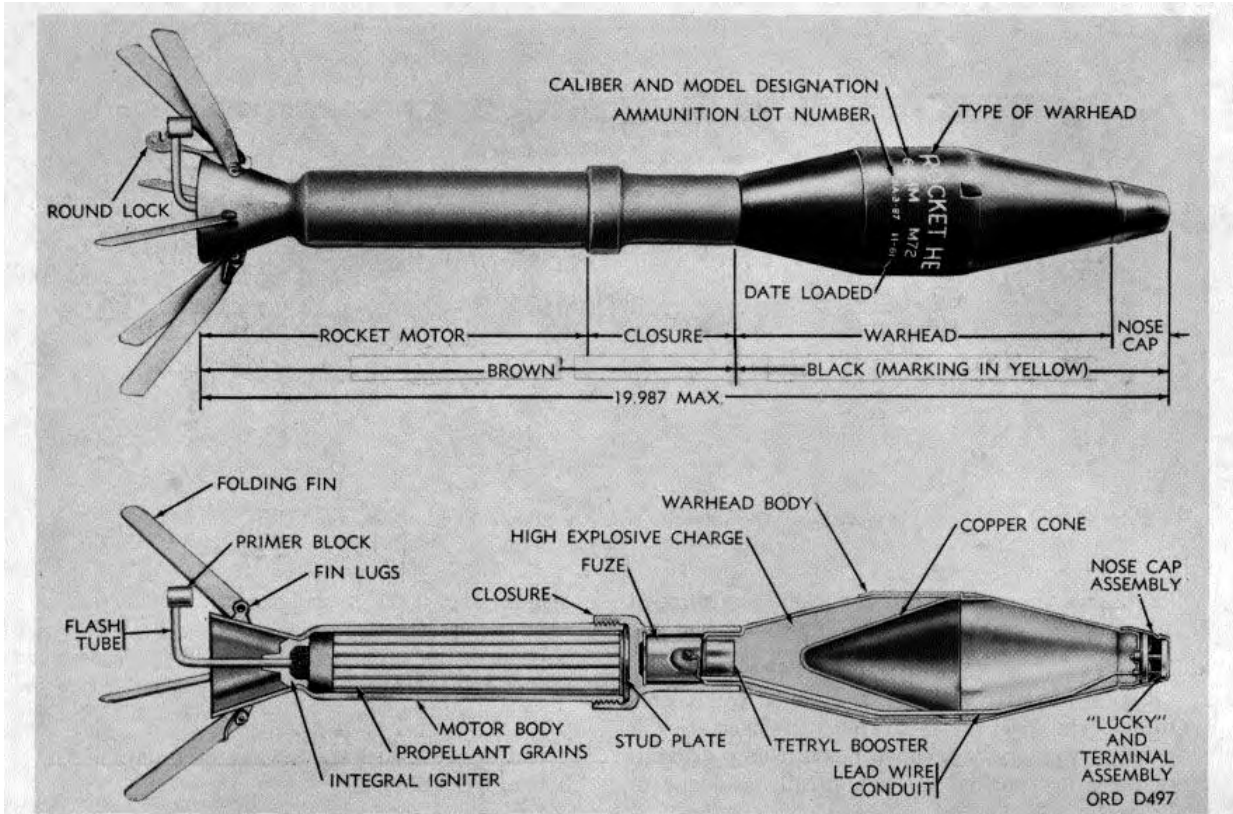

Figure 5-9. Exterior and cross section of 66-mm LAW rocket

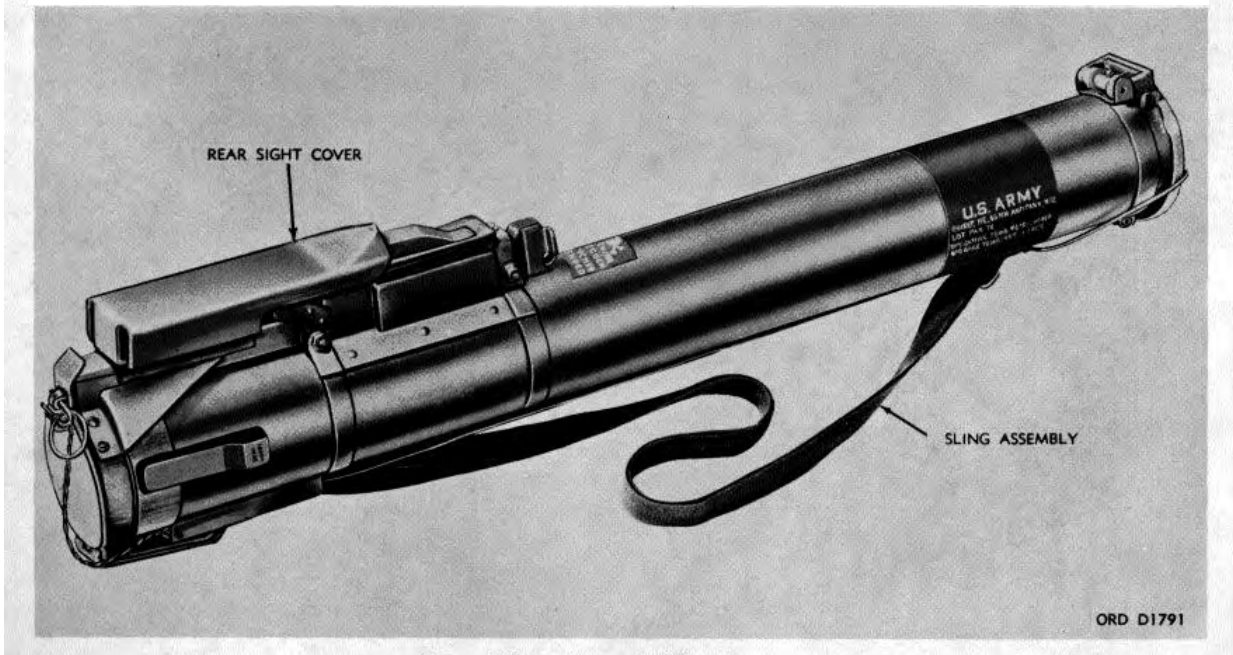

Figure 5-10. 66-mm LAW system.

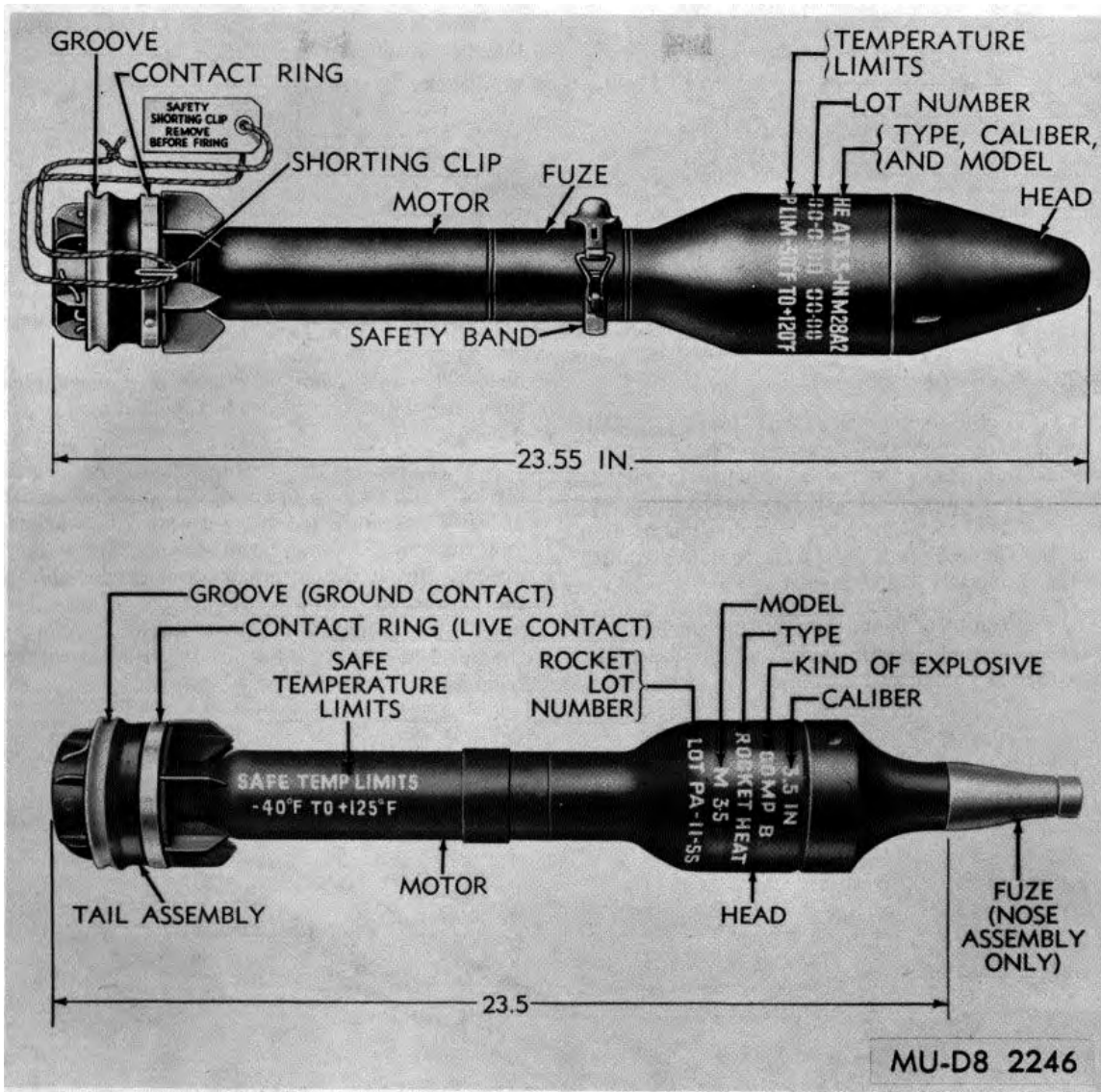

Figure 5-11. Typical 3.5-inch rockets.

Section VIII. SHOULDER-FIRED ROCKETS

5-21. General

Shoulder-fired rockets, ranging in size from 66 millimeters to 3.5 inches, are relatively light rockets used primarily against armored targets. They are also used for screening and practice. The 66mm rocket is distinguished by the fact that it is issued with a disposable launcher, as one unit. The rocket/launcher unit constitutes a complete Light Antitank Weapon (LAW) System.

5-22. Types

- a. Depending on the type of warhead, these rockets are designated HEAT, practice or smoke (WP).
- b. The 66-mm LAW system (fig. 5-9 and 5-10), has the following characteristics:

Rocket:
 Velocity 500 fps
 Range 325 m

Weight2.3 lb
 Length.....20 in
 Type.....HEAT
 FuzePIBD
 Stabilization Fin

c. The 3.5-inch rockets (fig. 5-11) have the following characteristics:

Velocity500 fps
 Range1,198 m
 Weight7.3-9 lb
 Length.....23 in
 Type.....HEAT, smoke
 (WP) practice
 Fuze.....BD
 Stabilization Fin
 Launcher Tube

Launcher:

Weight2.5 lb
 Length, closed25.7 in
 extended35.2 in
 Type.....Disposable

Section IX. GROUND-TO-GROUND ROCKETS

5-23. General

a. Ground-to-ground rockets are large (762-millimeter), free flight, solid propellant field artillery ammunition. They follow a ballistic trajectory similar to cannon-fired artillery projectiles, and are stabilized in flight by a combination of spin and fins. They have a maximum range capability of approximately 35,000 meters.

b. The complete round (fig. 5-12) consists of a warhead section, motor body and fin assembly. The fuze is considered a component of the warhead. The most commonly used is a mechanical time fuze which can be set to function at 5 to 120 seconds.

c. These rockets are distinguished by an assembly of spin rockets mounted in pairs around a pedestal assembly located between the warhead and the motor. When ignited, the spin rockets produce thrust which imparts a clockwise spin to the rocket and reduces the effects of misalignment. Spin is maintained in flight by the cant of the tail fins. The rocket is fired by remote control from a rail launcher.

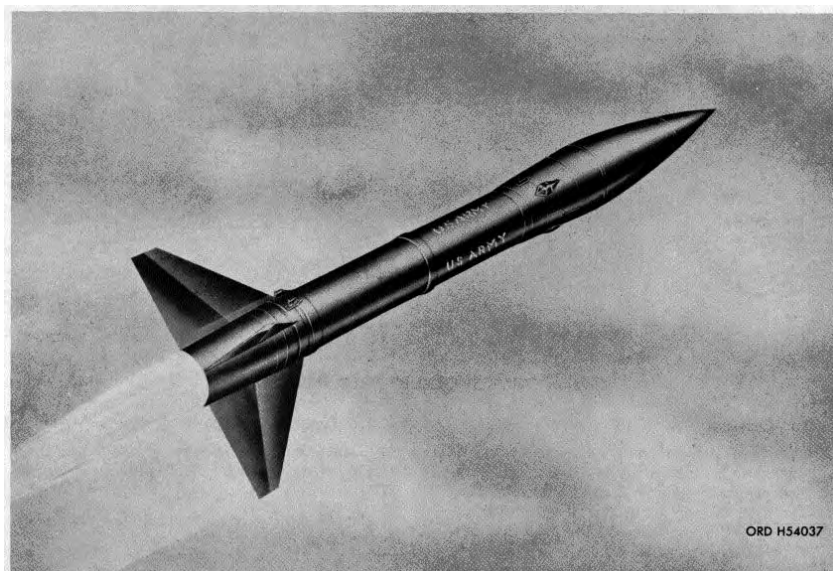

Figure 5-12. Long range ground-to-ground rocket.

Figure 5-12. Long range ground-to-ground rocket.

5-24. Types

a. Conventional warheads used with these rockets include HE, chemical and practice (flash-smoke).

b. The 762-mm rockets have the following characteristics:

Velocity.....	1,980-2,200 fps
Range.....	26,000--35,000 m
Weight.....	4,720-5,930 lb
Length.....	25--27 ft
Type.....	HE, chemical and practice
Fuze.....	MT
Stabilization.....	Fins and spin
Launcher.....	Straight rail

Section X. AIRCRAFT ROCKETS

5-25. General

a. Aircraft rockets can be employed effectively against other aircraft, personnel, personnel carriers, ammunition storage areas, fuel tanks, radar equipment and similar targets.

b. The folding fin aircraft rocket (FFAR) is a 2.75-inch air-to-air, air-to-ground rocket designed for deployment from highspeed fighter and attack aircraft.

c. The low-spin, folding fin aircraft rocket (LSFFAR) is a 2.75-inch air-to-ground rocket deployed from rotary wing and other low speed aircraft. It differs from the FFAR primarily in that the nozzles are scarfed to produce the low rate of spin required for launch at low speeds.

5-26. Type

a. Depending upon the type of warhead used, the complete round rocket (fig. 5-13) is classified as high explosive, high-explosive antitank, antipersonnel, spotting, smoke or practice.

b. These rockets, consisting of a warhead, fuze, and motor-and-fin assembly, have the following characteristics:

Velocity.....	1600-2200 fps
Range.....	500-800 m
Weight.....	18--29 lb
Length.....	48.8--2.8 in.
Type.....	HE, HEAT, APERS, spotting, smoke and practice
Fuze.....	PD, PROX, PIBD
Stabilizer.....	Fin
Launcher.....	Aircraft (multiple, nested tubes)

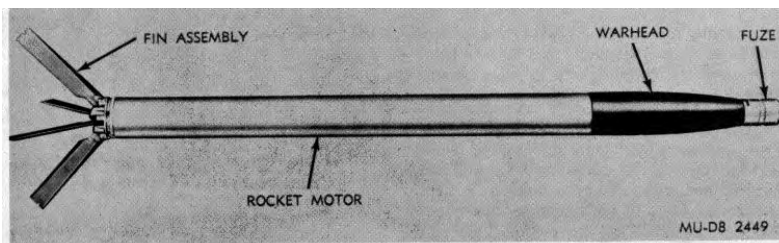

Figure 5-13. Typical 2.75-inch aircraft rocket.

Section XI. PRECAUTIONS IN STORAGE AND HANDLING

5-27. General

Assembled rockets (complete rounds) are generally similar to rounds of artillery ammunition. In the event of fire, however, unlike artillery ammunition, rockets ignited accidentally may be propelled over wide areas, and the range of the rocket must be considered in establishing danger areas (TM 9-1300-206). Because of this unusual explosive hazard, the precautions listed below will be observed in addition to those in chapter 1.

5-28. Care and Handling

- a. Because solid propellant compositions in rocket motors deteriorate readily, especially under extremes of temperature and humidity, keep rockets dry and cool.
- b. Do not expose rockets to direct rays of sun.
- c. Never store rockets where temperatures exceed limits marked on items.
- d. See that no moisture enters fuze or motor.

e. Examine nozzle closures of rockets subjected to wide temperature fluctuations for evidence of looseness that may have permitted moisture to enter motor. Moisture may damage propellant and affect accuracy.

f. Do not allow ice to accumulate on any part of motor. Such accumulation may cause erratic flight.

NOTE

At time of manufacture, warheads, motors and fuzes are made as nearly waterproof as practicable.

g. Do not remove such relatively delicate items as proximity fuzes from hermetically sealed containers until just prior to assembly of fuze to rocket.

h. Do not remove separately packed igniters from their packings, and do not break moisture resistant seals until unit is to be used.

i. Do not place complete round on its tail. This may damage fins or electrical connections. If necessary to stand round on end, point nose downward, so that it would bury itself in the ground if ignited accidentally.

j. Handle rocket motor or packings that contain rocket motors gently. Rough handling may damage components and create hazards. Cracked and broken propellant, for example, can cause dangerous pressures in motors when fired.

k. Prevent extraneous electrical currents (such as static) or induction by electromagnetic radiation (from such sources as high-amperage circuits and transmitters) from igniting rockets.

Section XII. FIRING PRECAUTIONS

5-29. General

a. Where requirements call for application of electrical energy to the igniter circuit of a rocket for testing continuity (such as during manufacture, renovation, or preparation for shipment), the testing devices used must be approved by the engineering agency responsible.

b. To provide for safety of personnel, select areas for these operations which are remote from sources of electrical currents, which might result in accidental ignition of the rocket.

c. Do not conduct continuity testing of circuits in rockets in ground launchers immediately prior to firing, or in rockets positioned on aircraft launchers immediately prior to takeoff, except under authority of, and with testing equipment approved by, the chief of the technical service concerned.

5-30. Special Precautions

a. Do not permit personnel to remain in triangular area directly behind rocket, where backblast occurs, unless they are protected by adequate shelter.

b. Always protect eyes when firing. Protect face and hands when firing at temperatures below freezing.

WARNING

Safe firing temperature limits are marked on each rocket. Firing at temperatures outside these limits may result in dangerously high pressures, erratic flight, duds or other malfunctions.

c. To avoid injury by accidental ignition of rockets during loading, see that loader does not stand directly behind launcher and rocket.

d. Do not use rockets with dented motors or fins. They may cause erratic flight.

e. Do not assemble rockets issued unassembled in amounts greater than immediate requirements.

f. During installation of rocket motors, assure security of mounting and attachment. An improperly or insecurely installed motor may break loose on firing and travel at a high velocity in an uncontrolled and unpredictable manner.

g. Remove safety devices as specified in preparation for firing, but at no other time.

h. Do not attempt to disassemble fuze or to remove base fuze.

i. Take care in firing through screen of brush or trees. Contact with limb, branch, etc., may deflect rocket or cause it to detonate.

WARNING

Misfires or hangfires may occur, especially under extreme weather conditions or other adverse circumstances (e.g., exposed electric lead wires and connections). Since misfires cannot be immediately distinguished from hangfires, certain periods of waiting before proceeding with firing are prescribed.

j. Regard duds (fired rockets in which warhead failed to explode) as dangerous. Do not handle. Have them destroyed in place by authorized personnel (TM 9-1300-206).

This page intentionally left blank.

CHAPTER 6

GRENADES

Section I. INTRODUCTION

6-1. General

A grenade is a small missile weighing between one and 1-1/2 pounds. Filled with high explosive or chemical, it is used against enemy personnel or materiel at relatively short ranges. There are two types: hand grenades and rifle grenades (fig. 6-1). For detailed information on hand and rifle grenades, see TM 9-1330-200-12 , TM 9-1330-200-34, and FM 23-30.

a. The hand grenade, thrown by the user, supplements small arms in close combat. It produces screening smoke and irritating gases and incendiary effects.

b. The rifle grenade is projected by a specially designed blank cartridge from a standard Army rifle equipped with a grenade launcher or adapter. Used against enemy tanks and for screening and signaling purposes, it covers ranges between the maximum for hand grenades and the minimum for mortar projectiles.

6 2. Classification

a. *General.* Grenades are classified according to method of projection as hand or rifle; according to use, as service, practice or training; and according to filler, as explosive chemical, illuminating inert or with a spotting charge filler.

b. *Method of Projection.* The basic classification of grenades is according to method of projection. Certain grenades are designed to be thrown by hand. Others are designed to be projected from a rifle by means of grenade launcher and a special grenade launching cartridge. Certain hand grenades are projected from rifles by means of grenade projection adapters and special blank grenade cartridges.

Change 5 6-1

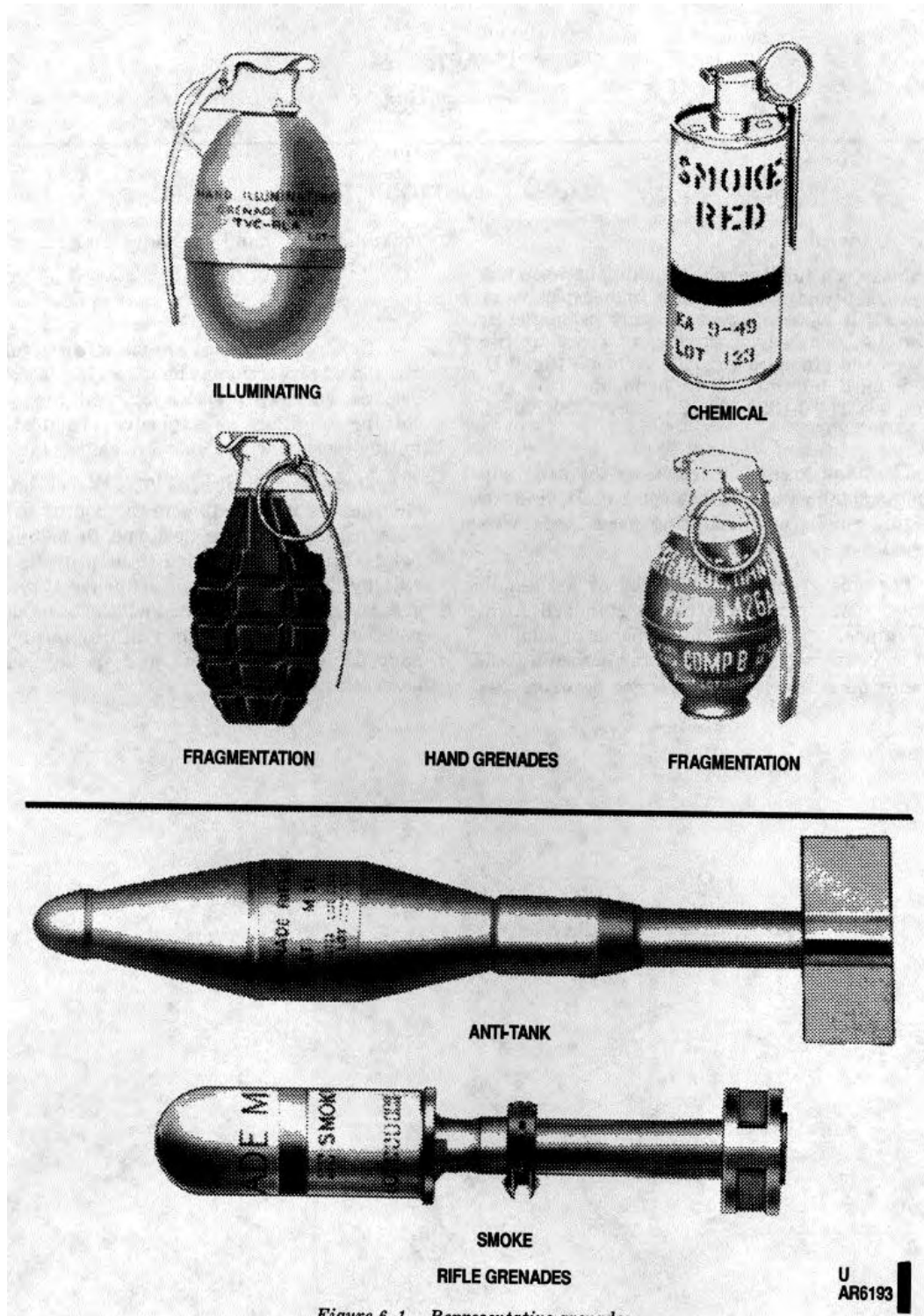

Figure 6-1. Representative grenades.

Section II. HAND GRENADES

6-3. Types

a. Service. Service hand grenades are classified according to use as fragmentation, offensive, chemical (burning or bursting) and illuminating.

(1) Fragmentation.

Warning

Do not use fragmentation grenades for training unless personnel have adequate cover.

The fragmentation grenade (A, fig. 6-2) has a thin metal body about the size and shape of a lemon, and weighs one pound. It is approximately 2.25 inches in diameter at the center and 3 inches long, unfuzed (3.9 inches long, fuzed). The body is lined with a notched, wire, fragmentation coil and contains 6 ounces of Composition B filler. This type of grenade was developed to replace the earlier model fabricated with a deeply serrated cast iron body (the pineapple World War I grenade). Fragmentation grenades are fused with either impact detonating or delay detonating fuzes composed of a striker, primer and delay charge detonator. A booster may be included. A safety lever, curved to conform to the shape of the grenade body, is hooked to the top of the fuze. The lever is held in place by a safety pin (pull ring), which protects the striker from action of the striker spring. In addition, grenades may have a second safety clip which fits around the lever. This provides a second means of restraining striker action. Safety pin removal is required immediately before the grenade is thrown.

NOTE

The procedure for throwing hand grenades is described in FM 23-30 and TM 9-1330-200-12 and TM 9-1330-200-34.

When the grenade is thrown, the striker, under the force of the spring, pushes the safety lever free. This permits the fuze to function either on impact or delay, depending on the type and model. Grenades fused with impact detonating fuzes are designed to detonate on impact with the target. However, Impact fuzes also contain a delay action system which will detonate the grenade within 3 to 7 seconds after the lever is released. Delay detonating fuzes contain a delay charge which is ignited by the primer. The primer, activated by the striker when the safety lever is released, ignites a delay charge. This

explodes the detonator and the bursting charge after a 4 to 5-second delay, fragmenting the grenade body and the fragmentation coil.

(2) *Offensive*. Offensive hand grenades (C, fig. 6-2) are cylindrical and about the size of fragmentation grenades. This type of grenade has a press-fiber (cardboard) body loaded with approximately one-half pound of flaked TNT. It employs a delay detonating fuze. Since the body of the grenade is cardboard, the main effect of the grenade is blast. However, some metal fragments from the fuze may be projected. This type of grenade is designed for demolition, final assault and use in rooms, caves and other closed areas.

(3) *Chemical*. The two types of chemical grenades, burning and bursting, are similar in size and shape. They differ primarily in filler and fuze. A typical chemical grenade (D, fig. 6-2) has a cylindrical body about 2 1/2 inches in diameter and 4 1/2 inches long, with the top and bottom crimped in place. Two less common body types, with serrated sides and a tapered end, describe a sphere and a modified cylinder, respectively. In burning-type grenades, there are emission holes (gas ports) to permit escape of the agent.

(a) *Burning*. These grenades are usually fitted with igniting fuses which function with a 1.2 to 2-second delay. Functioning of the fuze ignites the first-fire (starting) mixture which ignites the filler. The burning filler creates sufficient pressure to blow the tape (covering the gas ports) free and allow the chemical agent to escape. The following chemical agents are used as fillers:

1. CN-DM-Tear gas (CN), vomiting agent (DM), smokeless powder: burns 20 to 60 seconds; used for riot control.
2. CN-Tear gas: burns 20 to 60 seconds; used for riot control.
3. CS-Eye, nose and throat irritant: burns 15 to 35 seconds; used for riot control and training (as a simulated casualty agent).
4. HC-White smoke: burns 105 to 150 seconds; used for signaling.
5. Colored smoke--Green, red, violet, yellow: burns 50 to 90 seconds; used for signaling.
6. THS-Incendiary thermate: burns 80 seconds at +4,300°F.; used to destroy equipment.

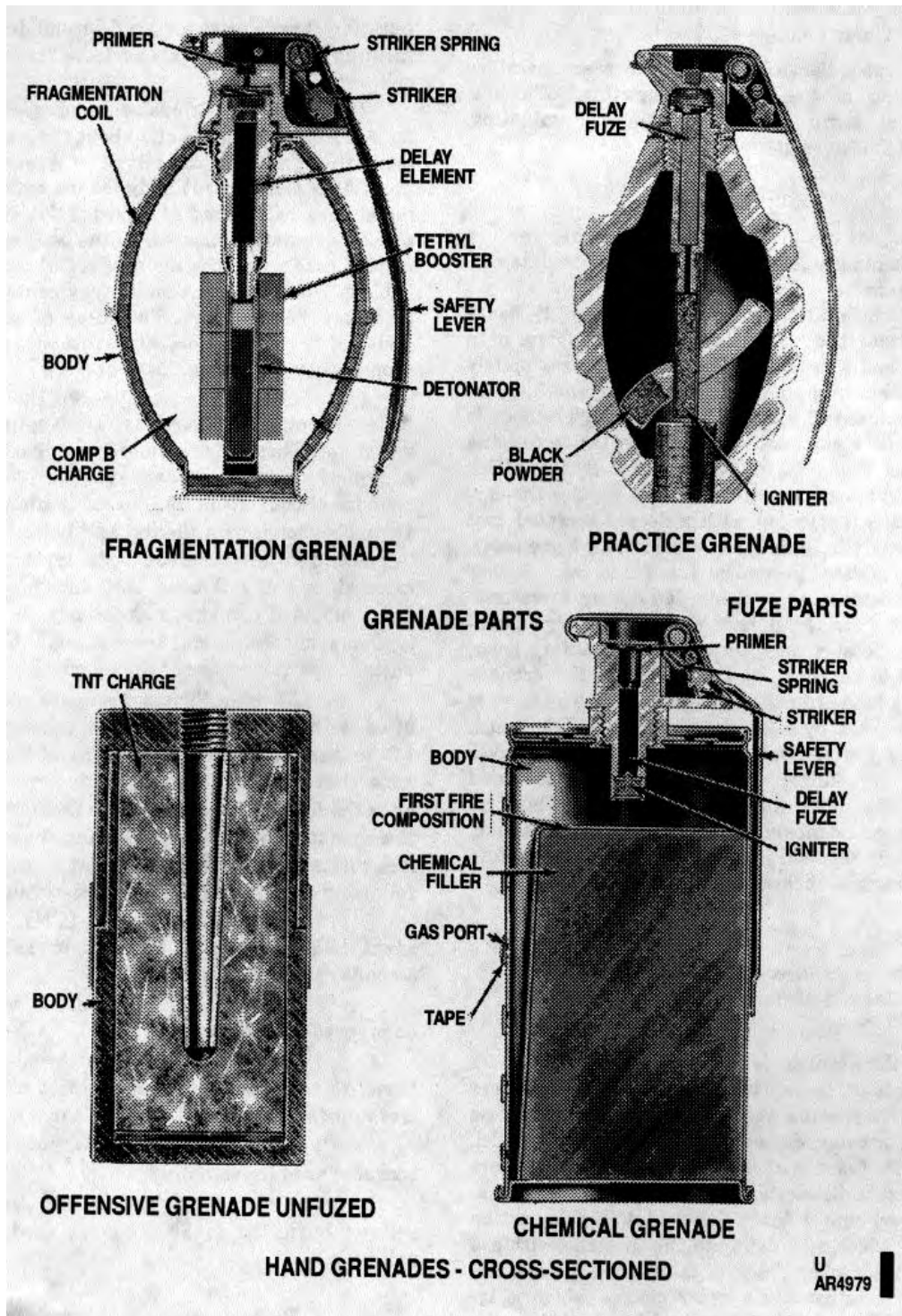

Figure 6-2. Hand grenade types.

(b) *Bursting.* These grenades are fuzed with delay fuzes which contain high-explosive detonators. The detonators rupture the grenade body and disperse the filler. There are two types of filler:

1. CN-1-Tear .gas: used in special purpose, spherical-shaped riot control grenades.

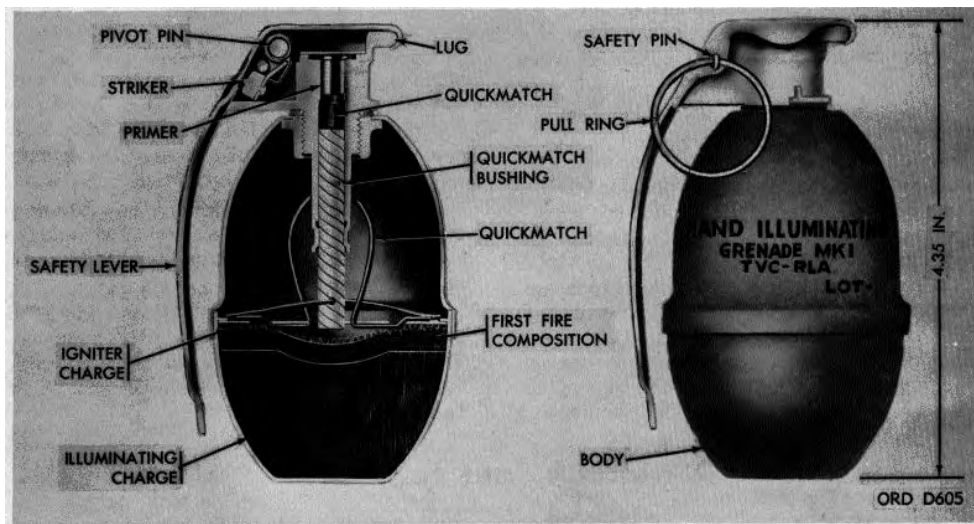

Figure 6-3. Illuminating hand grenade.

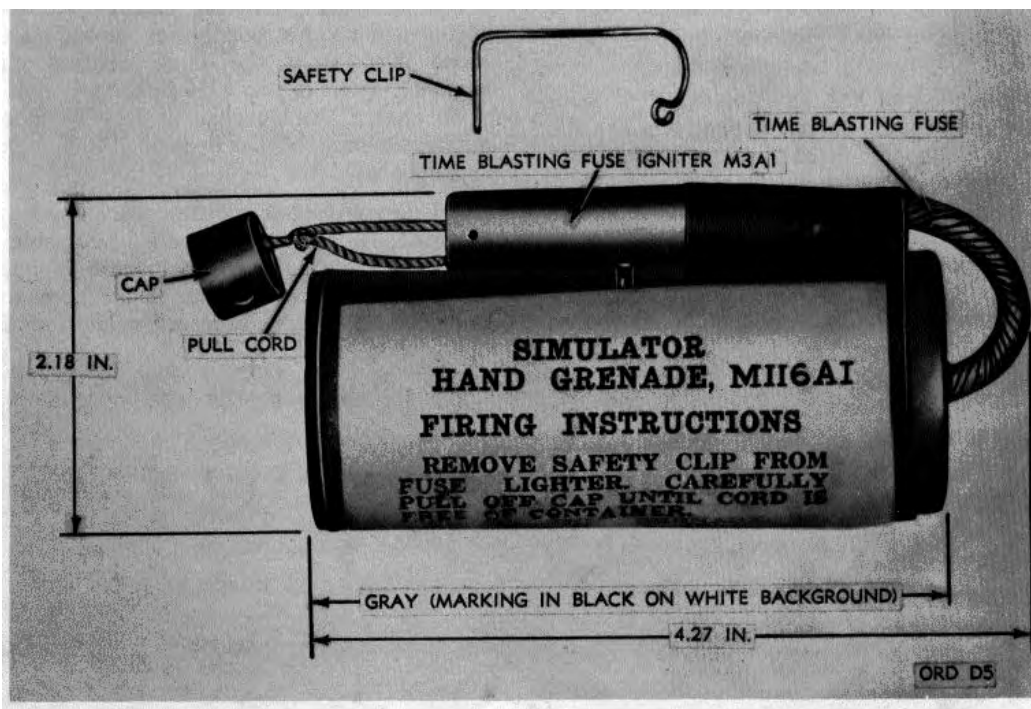

Figure 6-4. Hand grenade simulator.

Although this type of grenade functions by bursting, it creates the same effect as burning grenades.

2. WP-White phosphorus: burns 60 seconds; used for signaling, smoke screening, and for antipersonnel and incendiary purposes. When WP is released, it ignites spontaneously on contact with the air, burning with intense heat and forming a dense white smoke.

(4) *Illuminating.* This type of grenade (fig. 6-3) is used for signaling and battlefield illumination. Because the illuminant compound burns with a very hot flame, this type can also be used for incendiary purposes against flammable targets. A typical illuminating grenade is similar in size and function to burning-type chemical grenades. It consists of three basic components: a thin, sheet-metal body, an illuminating charge, and a special, igniter-type fuze. The igniter consists of a quick-match contained in a bushing. The illuminating charge consists of a pyrotechnic composition, a first-fire composition and an

igniter charge. The illuminant burns for approximately 25 seconds at 55,000 candlepower, illuminating an area approximately 200 meters in diameter.

b. Practice, Training and Simulating.

(1) A typical practice grenade (B, fig. 6-2) contains a small spotting charge of black powder and is fuzed with a 4to 5-second delay igniting fuze. This type of grenade is used to simulate operation and functioning of service grenades.

(2) Training grenades are unfuzed and completely inert. They resemble service rounds in size and shape, and are used for training in handling and throwing.

(3) Simulators (fig. 6-4) provide realistic battle noises and effects during troop maneuvers. They consist of sealed paper tubes containing photoflash powder, a short piece of time blasting fuse, and a fuse igniter.

Section III. RIFLE GRENADES

6-4. General

Rifle grenades are fin-stabilized projectiles launched from rifles equipped with grenade launchers. The propelling force for the grenade is provided by a special gas-producing grenade cartridge.

a. A grenade launcher (fig. 6-5) functions as an extension of the rifle barrel. It is attached to the muzzle by a clip latch fitted over the bayonet stud of the rifle. A hollow stabilizer tube on the grenade fits over the barrel of the launcher and is secured by a clip retainer spring. (Some newer model springs are designed to hold the grenade in position in the rifle barrel without requiring a separate launcher.) Numbered annular grooves on the barrel of the launcher provide variations in range,

depending on the groove at which the grenade is placed.

b. A launcher positioning clip is used to aid in uniform and rapid positioning of multiple grenades fired from the same position on the launcher. The clip is a 5/16-inch, steel strip bent to fit around the launcher. It may be moved to different numbered positions on the launcher to facilitate rapid fire.

c. Grenade cartridges (fig. 6-6) are specially designed blanks which generate a large volume of high pressure gas. When the grenade cartridge is fired, this gas provides the thrust necessary to propel the rifle grenade from the launcher to the target.

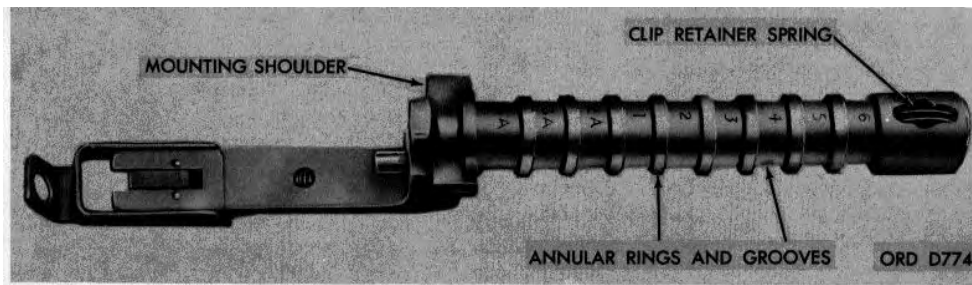

Figure 6-5. Grenade launcher.

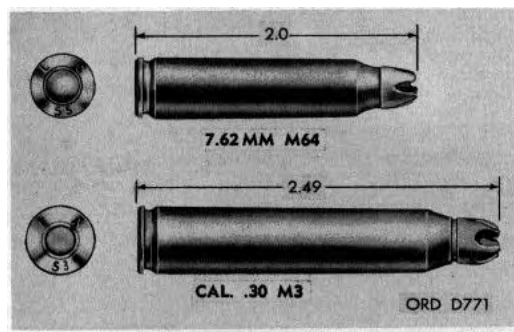

Figure 6-6. Grenade cartridge.

A 5-point, rose-petal crimp on the wad end of the cartridge distinguishes grenade cartridges from other blank rifle cartridges. (The two types not interchangeable.)

d. Grenade projection adapters (fig. 6-7) are used to convert high-explosive and chemical hand grenades to rifle grenades. A typical adapter consists of a stabilizer fin assembly. Three springsteel claws on the stabilizer grip the grenade body. A frangible arming clip is assembled to one claw. When the grenade is placed in the adapter, the safety lever of the grenade is inserted in the arming clip to hold the lever in place until the grenade is fired. (The safety pin is removed prior to firing.) On firing, the arming clip moves to the rear, breaking free from the adapter. This releases the grenade lever, which initiates the fuze.

6-5. Types Rifle grenades are classified according to use as service (fragmentation, high-explosive antitank and chemical) and practice. Types designed exclusively for projection by rifle are the high-explosive antitank, practice and smoke rifle grenades.

a. The high-explosive antitank grenade (fig. 6-8) which is used against tanks and armored vehicles, consists of a fuze, a body assembly, an adapter, a stabilizer tube and a fin assembly. The body

contains about 12 ounces of high explosive shaped around a copper cone. The fuze is an electric, point-initiating, base-detonating type. A piezo-electric element in the nose of the grenade provides the power source for the fuze. On impact, the piezoelectric element generates an electric current which initiates the explosive train in the fuze. The main charge is detonated by a booster. Detonation of the charge creates a jet of hot gas and metal particles which penetrate the target.

b. Smoke rifle grenades are designed primarily for producing smoke: either for signaling or screening purposes. One type of smoke grenade, the white phosphorus (WP) grenade, also has incendiary capabilities. It may be used to ignite flammable targets or inflict injury on personnel. There are three basic types of smoke rifle grenades: the WP smoke grenade, the colored smoke grenade, and the colored smoke streamer grenade. The WP smoke grenade functions on impact, bursting the body and scattering particles of burning white phosphorus over a large area. The colored smoke grenade functions on impact, emitting a cloud of colored smoke for approximately one minute. The colored smoke streamer grenade functions on firing, emitting a stream of colored smoke as a trail during its trajectory.

c. Practice rifle grenades are designed for training personnel in care, handling and use of rifle grenades prior to training with live or service grenades. This type of grenade is completely inert (no filler or fuze). It may be fired to the target with only minimal effect on the practice target used.

d. Certain fragmentation, chemical and practice grenades can be changed to rifle grenades by fitting standard model hand grenades with projection adapters (fig. 6-7). Colored smoke and WP grenades, adapted for rifle projection, are illustrated in figures 6-9 and 6-10.

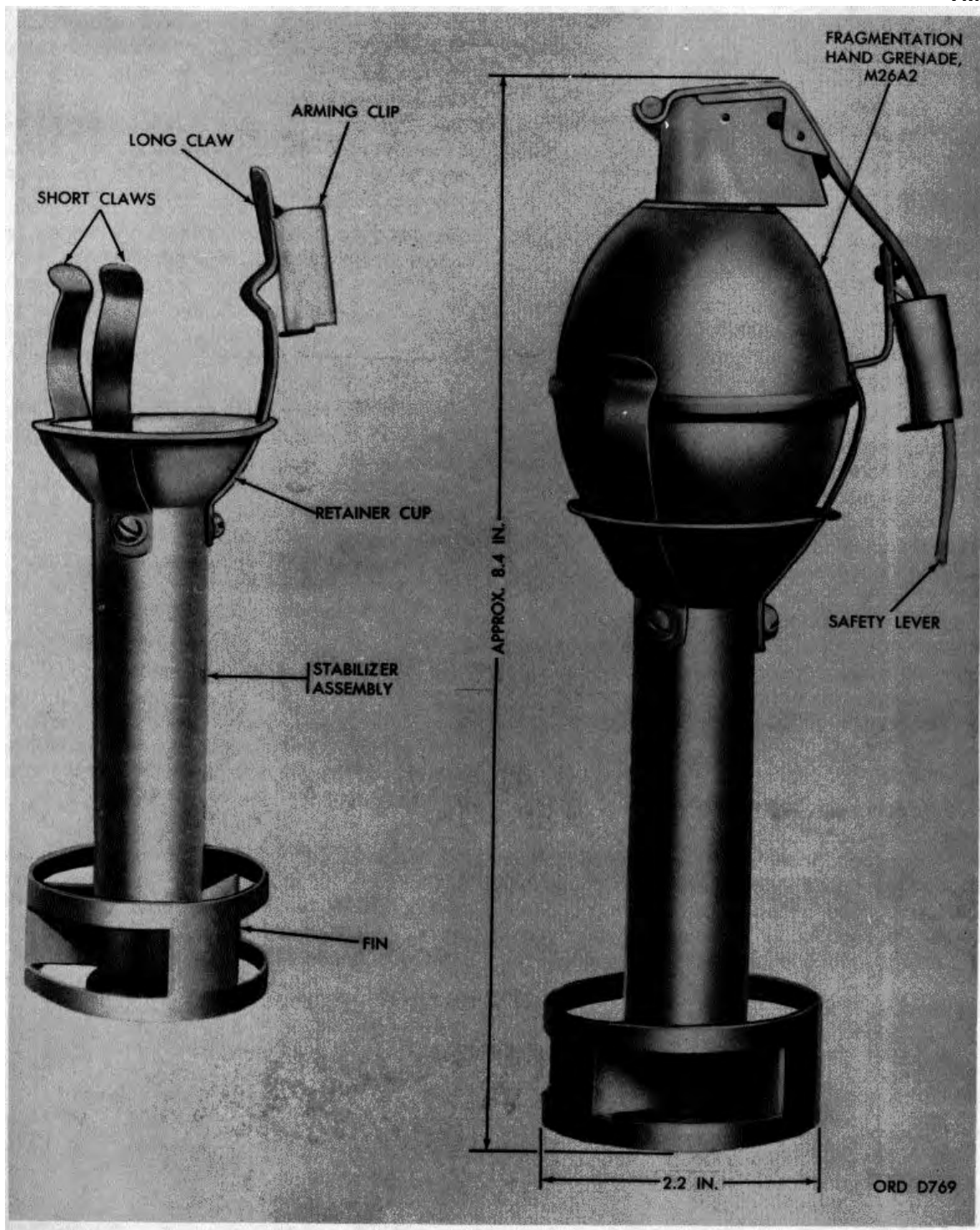

Figure 6-7. Projection adapter.

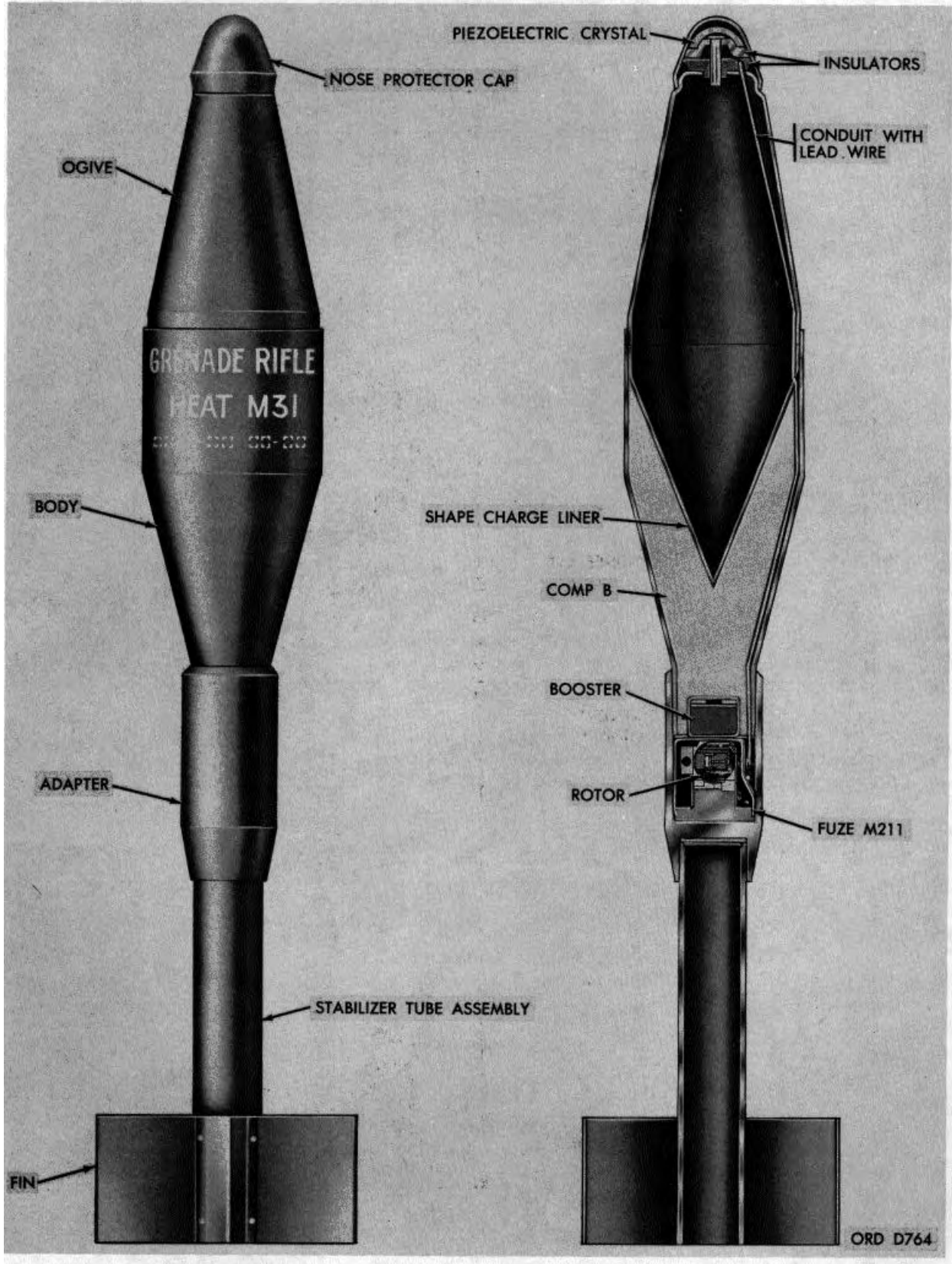

Figure 6-8. HEAT rifle grenades.

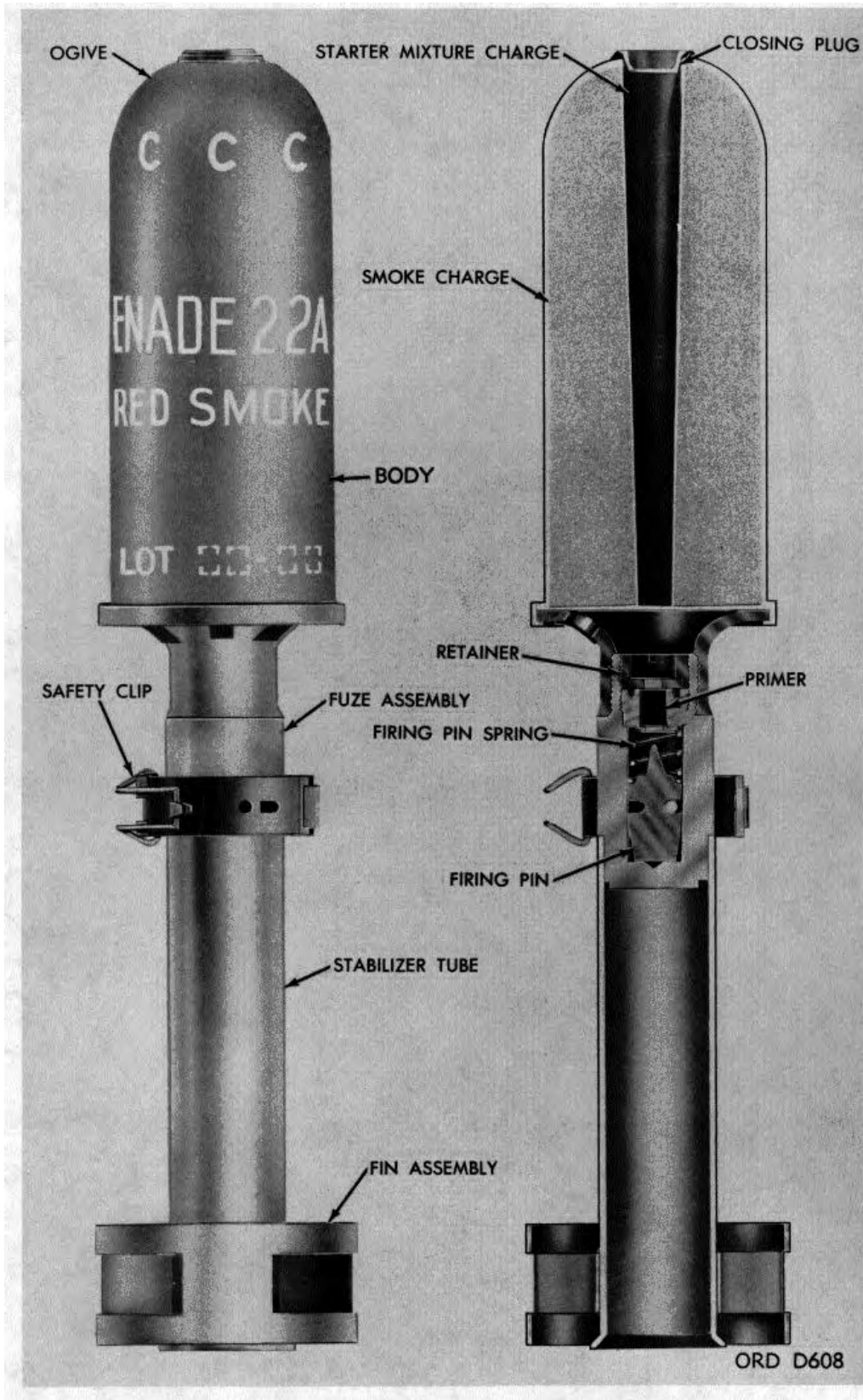

Figure 6-9. Burning-type (colored smoke) rifle grenade.

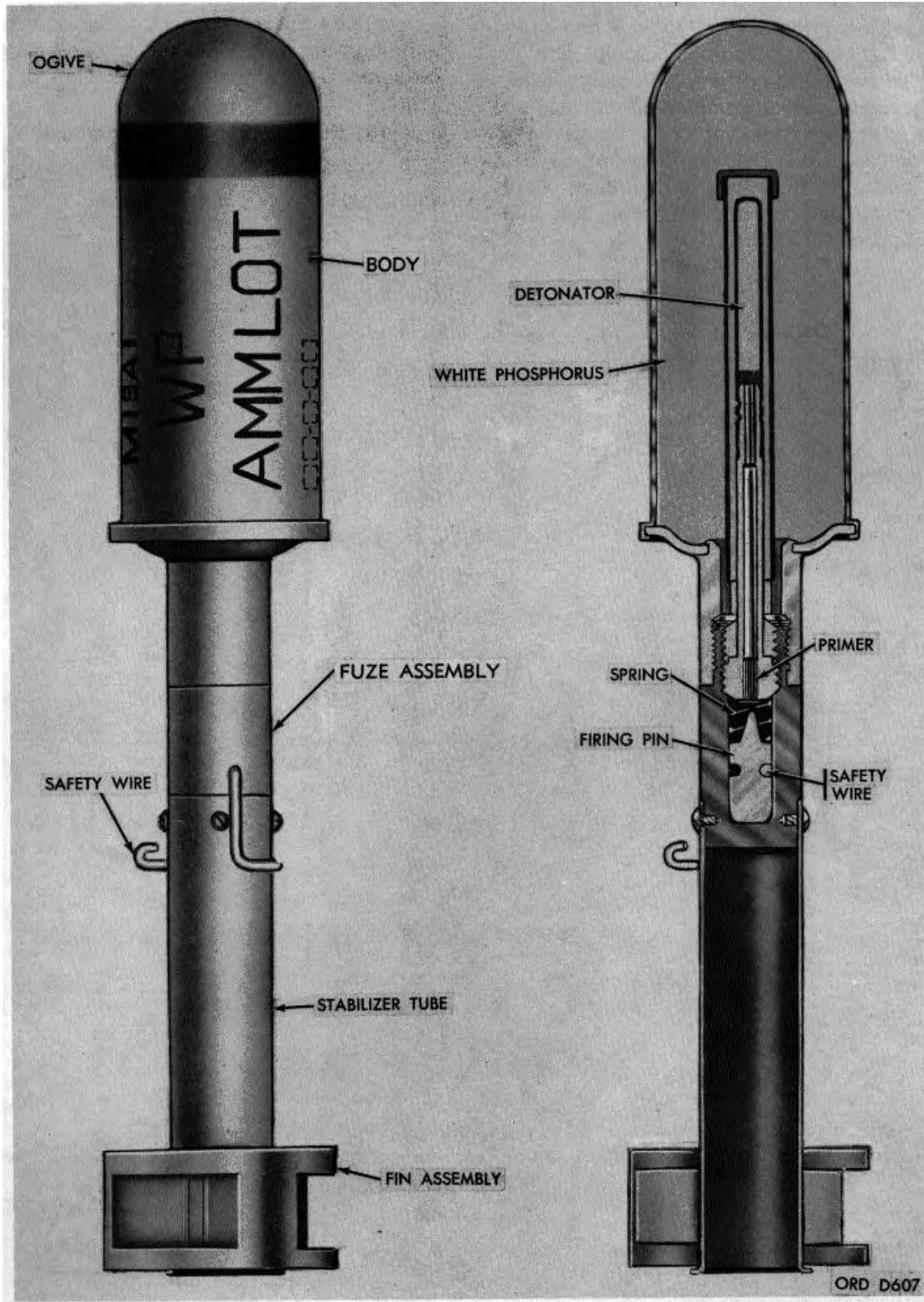
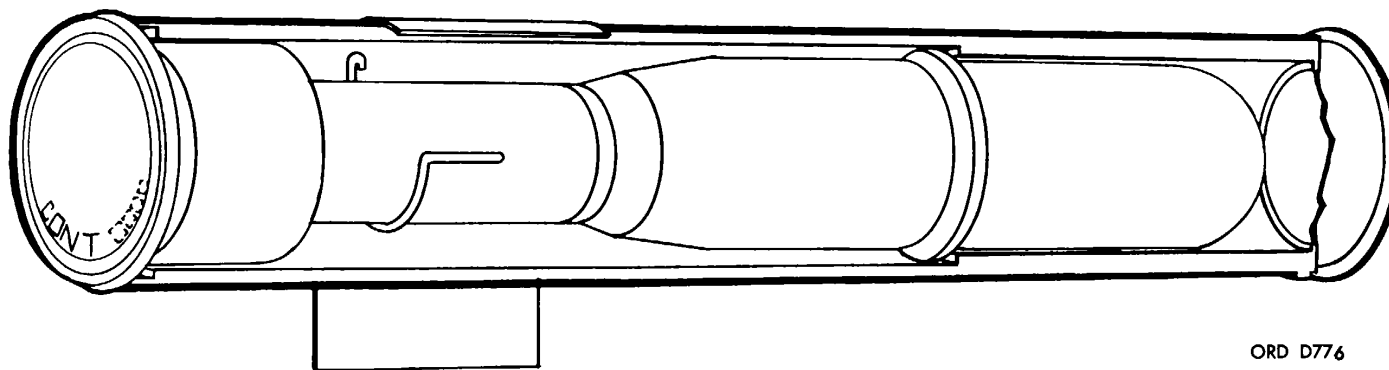
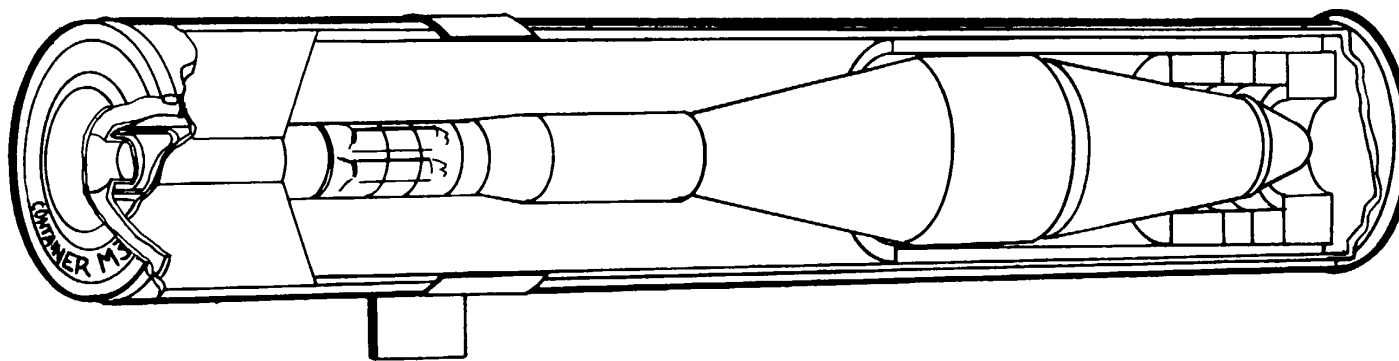

Figure 6-10. Bursting-type (WP smoke) rifle grenade.

Section IV. IDENTIFICATION AND PACKING**6-6. General**

a. Grenades are packaged and marked in accordance with pertinent specifications and drawings. Inner (fiber) and outer packages are designed to withstand conditions ordinarily encountered in handling, storage and transportation, and to comply with Department of Transportation regulations. Packing and marking data are given in chapter 1; also, in SC 1305/30-IL and SC 1340/ 98-IL. Typical packing and markings are illustrated in figures 6-11 and 6-12.

- b. Marking includes all information required:
- (1) For complete identification of contents.
 - (2) By the Department of Transportation for shipping, including addresses of consigner and consignee and shipping designation of the contract.
 - (3) For handling, storage and use.
- c. For detailed information on packing and marking, refer to TM 9-1330-200.



ORD D776

Figure 6-11. Typical fiber container for rifle grenades.



Figure 6-12. Typical packing boxes for grenades.

Section V. PRECAUTIONS IN STORAGE AND HANDLING

6-7. General

Grenades must be handled with care at all times. Fuzes, particularly, are easily damaged by mishandling and may become hazardous. Grenades and fuzes, either stored or issued, should be protected against moisture and excessive changes in temperature.

6-8. Care and Precautions in Handling

General precautions covering use of ammunition are outlined in chapter 1 and in TM 9-1300-206 and AR 385-63. Specific precautions pertaining to grenades are contained in TM 9-1300-200-12, TM 9-1300-200-34 and FM 23-30.

a. Treat all grenades and components as potentially dangerous, whether fully loaded or those designated as inert.

b. Avoid striking or dropping, or handling in other than manner prescribed for explosive loaded (live) items.

c. Treat inert-loaded grenades and components with same degree of caution as their explosive or chemical-loaded (live) counterparts.

d. Do not lift or handle hand grenades by pull ring attached to safety pin of fuze. Remove safety pin just before throwing or just before launching if hand grenade is fitted to grenade-projection adapter, and at no other time.

e. Once a hand grenade has been inserted into grenade-projection adapter, do not remove without first reinserting safety pin.

f. Do not lift or handle rifle grenades by pull ring attached to safety pin. Handle with care to prevent damage to stabilizer assembly.

g. Do not place grenade on launcher unless it is intended to be fired immediately. If grenade is not fired, render it safe by replacing safety pin before removing it from launcher.

Section VI. PRECAUTIONS IN FIRING

6-9. General

Detailed information concerning safety precautions to be observed in firing grenades is contained in AR 385-63, TM 9-1330-200-12, TM 91330-200-34, and FM 23-30.

6-10. Special Precautions

a. Do not recover live grenades that have failed to explode (duds). Dispose of duds in, accordance with provisions of TM 9-1300-206.

b. Use appropriate rifle grenade and prescribed combination of launcher and cartridge.

c. Assure that hand grenades are attached to adapter and prescribed combination of launcher and grenade cartridge is used to launch hand grenades from rifle.

d. Never launch rifle grenades or adapted hand grenades with other than special grenade launching cartridges provided for that purpose.

e. Do not use bullet cartridge to project grenade or ground signal from launcher under any circumstances. Injury to personnel and damage of weapon may result.

f. Do not pull safety pin until just before throwing or launching grenade.

g. During safety pin removal, hold safety lever firmly in place (as prescribed in FM 23-30) until grenade is thrown, tossed, or placed in position.

h. Silent type fuzes (identified by T-lug which protrudes from top of fuze to slot in safety lever) are used in most grenades. Therefore, never consider projected grenades as duds because no noise, smoke, or sparks are observed upon release of safety lever.

THIS PAGE INTENTIONALLY LEFT BLANK

Change 5 6-16

CHAPTER 7

LAND MINES

7-1. General

A land mine is a device filled with high explosive or chemicals, intended for placement on the ground or beneath the surface. It is designed to destroy or damage vehicles, hinder movement of enemy personnel, or contaminate strategic areas. It may be detonated when its target touches or moves near it or by remote control. Land mines, their components, and ammunition for simulated boobytraps and land mine fire are listed in SC 1340/98-1L For technical information on land mines, see TM 9-1345-203-12&P and TM 43-000136; for tactical information, see FM 20-32.

7-2. Classification and Identification

a. Classifications. Land mines are classified according to purpose as service or practice, and according to filler as high explosive, chemical or inert. They are further classified according to use as antipersonnel (APERS) or antitank (AT). An APERS mine is designed for use against enemy personnel. An AT mine is designed to immobilize or destroy enemy tanks or other vehicles.

b. Identification.

(1) In the case of service AT mines, the designation HE (high explosive) appears in the nomenclature. Practice mines are marked PRACTICE, INERT OR EMPTY. Nomenclature is marked on the items and on the packing boxes.

(2) Land mines are painted in accordance with the color coding indicated in chapter 1.

7-3. Service APERS Mines

a. General. Service APERS mines are used primarily to restrict or delay movement of enemy foot troops. These mines consist of an amount of high explosive, generally less than one pound, in a container fitted with a fuse. The fuse is activated by pressure or release of pressure, by pull on a trip wire, or by cutting a taut trip wire.

b. Fuzes. Functioning of APERS mines is initiated by various types of fuzes. The fuse serves to transform

mechanical action, such as pressure on the fuse or pull of a trip cord. For example, a detonating fuse provides an explosive force which detonates the high-explosive charge. An igniting fuse provides a burning action which ignites the propelling charge of a bounding-type APERS mine.

c. Types. APERS mines consist of two basic types (fig. 7-1): fragmentation and blast. Fragmentation types are further defined as bounding, fixed directional and fixed non-directional.

(1) *Bounding type.* This type mine (fig. 7-1) is placed beneath the surface of the ground. When the mine functions, a fragmentation projectile is expelled from the mine body. The ascending projectile explodes at a height of approximately 1 to 2 meters (3 to 6 feet) above the ground, propelling fragments in all directions.

(2) *Fixed-directional type.* This type (fig. 7-1) is placed on the ground or attached to an obstacle, such as a tree or pole, in the expected path of the enemy (fig. 7-2). When the mine explodes, fragments fan outward in a 60 degree arc above the ground.

(3) *Blast type.* This type (figs. 7-1 and 7-4) depends for effect on direct force developed by explosion. The mine functions without delay while still in contact with the enemy who has initiated it. The mine has an all plastic body and an integral plastic fuse with a steel firing pin. Because it is practically nonmetallic, the mine is non-detectable by magnetic mine detectors. The fuse detonates the main charge directly.

7-4. Practice and Inert APERS Mines

a. General. Practice mines have the same features and weight as the service mines they represent. Practice mines usually contain small quantities of explosive (usually black powder) or smoke or noisemaking composition to simulate functioning of a service mine. Inert mines, which are completely inert, are used for practice in handling.

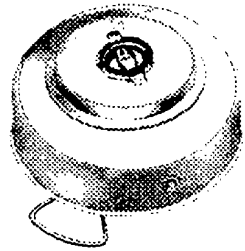

HEAVY

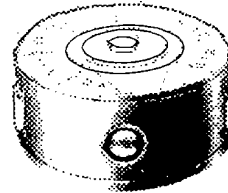

LIGHT

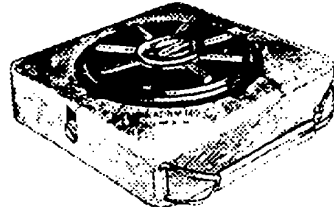

NON-METALLIC

ANTI-TANK

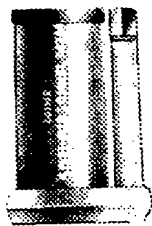

BOUNDING TYPE

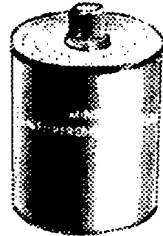

BLAST TYPE

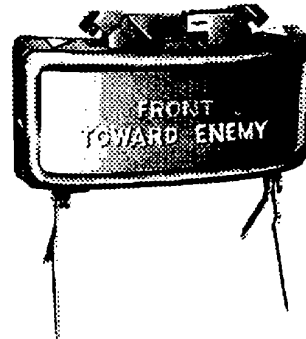
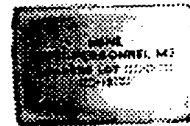

FRAGMENTATION TYPE

ANTI-PERSONNEL



CHEMICAL

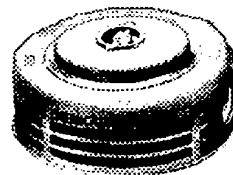

U
AR4980

Figure 7-1. Representative types of land mines.

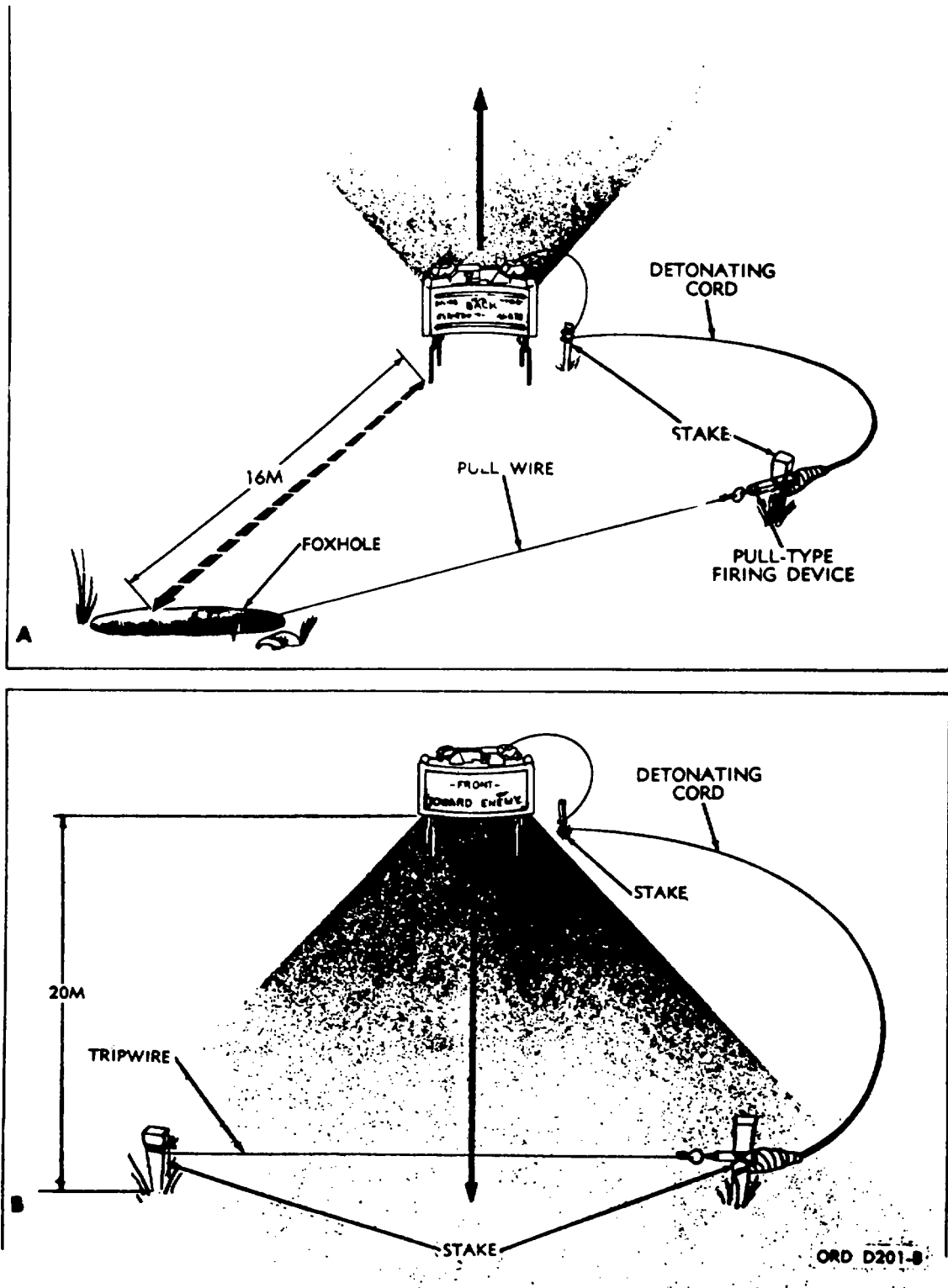

Figure 7-2. APERS mine ready for firing:
A---by observer B---by enemy

b. Fuzes. Practice mines are provided with practice fuzes having firing mechanisms fitted with primers and igniters. When initiated, the firing mechanism ignites the spotting or propelling charge in the mine. Inert mines are provided with completely inert fuzes.

c. Types. Practice APERS mines simulate the basic type:

(1) Bounding-fragmentation type. This practice mine (fig. 7-3) has no projectile. Otherwise, it has the same metal parts as the corresponding service mine. Actuation of the firing mechanism causes the firing pin to hit the primer. The primer ignites a delay train which burns for 4 or 5 seconds before initiating the igniter. When the igniter charge ignites the smoke pellets and expels the mine cap, yellow smoke is emitted from the igniter tube and smoke pellets.

(2) Deleted.

(3) Nonmetallic practice APERS mine, N17. This mine (fig7-3.1) is the practice version of mine, antipersonnel, NM, M14, with integral fuze. The N17 like the N14, is detectable by metallic-type mine detectors, and is not reusable. Unlike the H14, the M17 provides a 1 to 2 second delay between activation and functioning. The mine cannot cause injury to the person initiating it or personnel in the immediate vicinity. To provide the visible and audible signal required for the practice mine, the N17 contains an expelling charge, a smoke charge and two small firecrackers. The expelling charge blows the fuze portion of the mine and the two firecrackers out of the ground. The firecrackers function either in the air or on top of the ground. The smoke charge stays in the ground and burns for approximately 5 seconds, causing a smoke cloud to issue from the hole made by the expelled fuze. The N17 practice mine has the following characteristics: Force of 20 to 35 pounds applied to the pressure plate of the armed mine will cause the mine to function. A man's weight is sufficient to activate a mine M17 buried to a depth of 1/2 inch or less. The N17 is designed to withstand exposure to alternate freezing and thawing periods. Until the mine is armed, the safety clip prevents downward motion of the pressure plate. If the safety clip is removed, the mine remains safe until the pressure plate is turned from the safe (S) position to the armed (A) position (fig.7-3.1). This motion disengages the key lock from the lock ring and turns the pressure plate clear of the spider, permitting downward motion of the pressure plate. Any weight on the pressure plate will then be transmitted to the firing pin spring assembly. If a weight of 20 to 35 pounds is so applied, the bellville spring will snap through center, causing the firing pin to initiate the primer charge. The initiating charge then ignites the fuse delay which burns for 1 to 2 seconds before initiating the igniter. The igniter

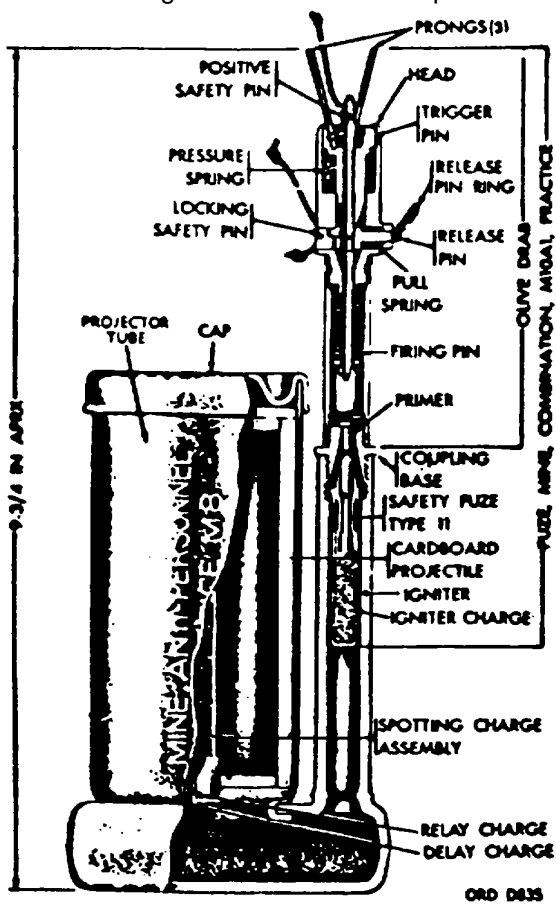

Figure 7-3. Typical bounding-type practice APERS mine.

initiates the prime charge igniters which in turn initiate the smoke charge and the firecrackers. The igniter TM

9-1300-200 also initiates the expelling charge which blows the fuze assembly out of the ground.

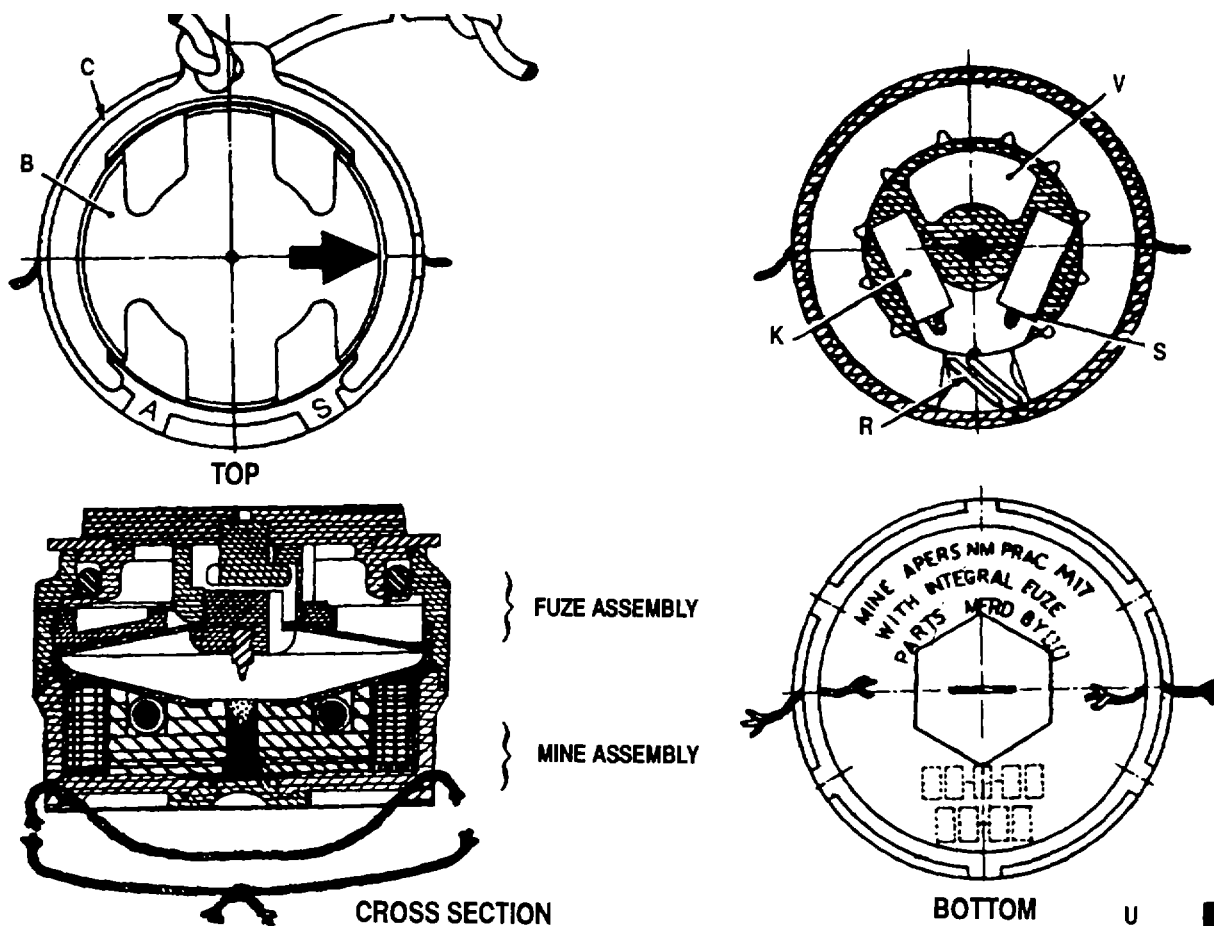

Figure 7-3.1. Typical nonmetallic practice APERS mine.

Figure 7-3.1. Typical nonmetallic practice APERS mine.

7-5. Service AT Mines

a. *General.* Service AT mines (fig. 7-5 and 74) are explosive devices placed on, or slightly below the surface of the ground. They are used primarily to restrict or delay movement of enemy vehicles. AT mines will usually destroy a small unarmored vehicle. Although they may not always destroy an armored tank, AT mines can be relied on to incapacitate it, usually by damaging its tracks. Unless they are run across, heavy AT mines are usually not dangerous to foot troops. However, by use of secondary fuze wells and suitable firing devices, AT mines can be boobytrapped. Most AT mines are of the blast type. They depend on the force developed by the explosion to break tank tracks or propel a mass of steel upwards into the tank. AT mine and fuze technical data, details of construction, and methods of handling individual mines are covered in TM 9-1345-203-12&P. Performance and tactical use are covered in FM 20-32.

b. *Fuzes and Other Components.* Fuzes are used to activate AT mines. The fuze functions when a load is applied to the fuze pressure plate. Pressure on the plate causes the firing pin to be driven into the fuze detonator, exploding it. In turn, this explodes the booster and the main charge. AT mines employ boosters to amplify the explosive force of the detonator in the fuze and to assure initiation of the main charge in the mine. Most AT mines are provided with secondary fuze wells for use in boobytrapping. A secondary fuze usually consists of a standard firing device threaded into an activator (fig. 7-7) which serves as an adapter-detector for the firing device. These activators are essentially detonator-boosters. The activator performs the function of an adapter for the firing device.

e. *Types.* Service AT mines consist of four basic types: heavy metallic, heavy nonmetallic, light (obsolete) and off route.

THIS PAGE INTENTIONALLY LEFT BLANK

Change 5 7-4.2

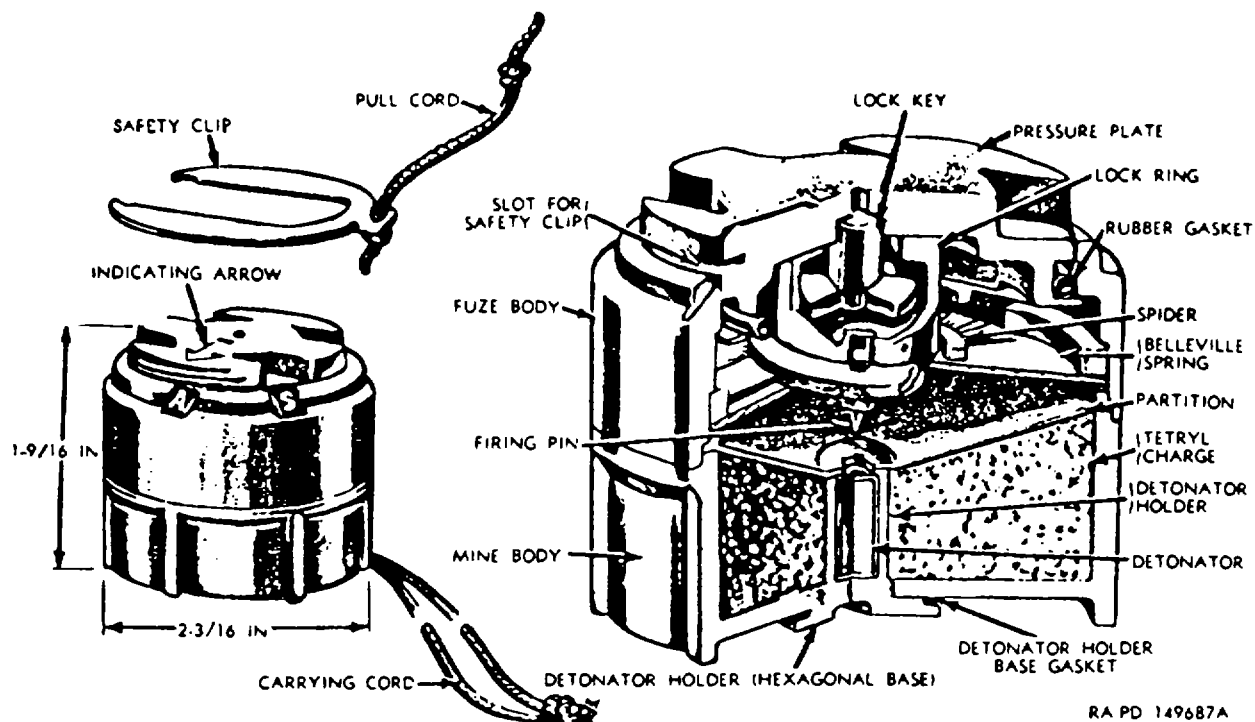

Figure 7-4. Nonmetallic APERS mine.

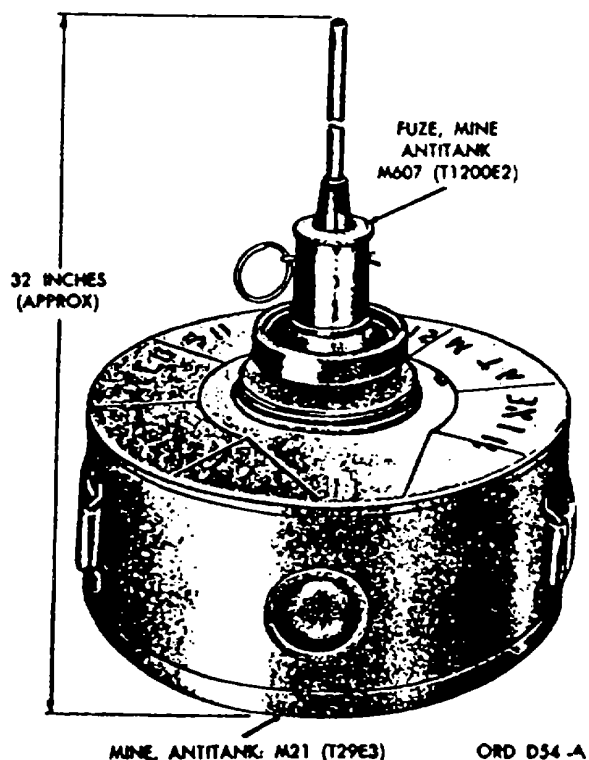

Figure 7-5. Heavy AT mine

(1) *Heavy metallic type.* Heavy metallic mines derive effectiveness against armor from energy produced by the high-explosive charge.

This propels a mass of steel in an upward direction at a velocity sufficient to penetrate the tank armor.

(2) *Heavy nonmetallic type.* Mines of this type (fig. 7-8) derive effectiveness from energy produced by the high-explosive charge. This cracks or damages tank tracks. This mine cannot be detected with small magnetic detectors.

(3) *Light type.* The light AT mine (fig. 7-9) is intended for use against light tanks and vehicles. By use of secondary fuze wells and firing devices, it can be adapted for boobytrapping. This mine derives its effectiveness from the blast effect produced by explosion of the high-explosive charge.

(4) *Off-route type.* The off-route mine (fig. 7-10) is intended for use against heavy-duty, wheeled and tracked vehicles (tanks, etc.). It employs a rocket launcher containing a HEAT pocket. The launcher is mounted approximately 50 or 100 feet off the route or line of target travel. It is initiated by a pressure-actuated tape stretched across the target route. Pressure on adjacent segments of the tape closes electrical circuitry to a ring device which fires the rocket. The rockets

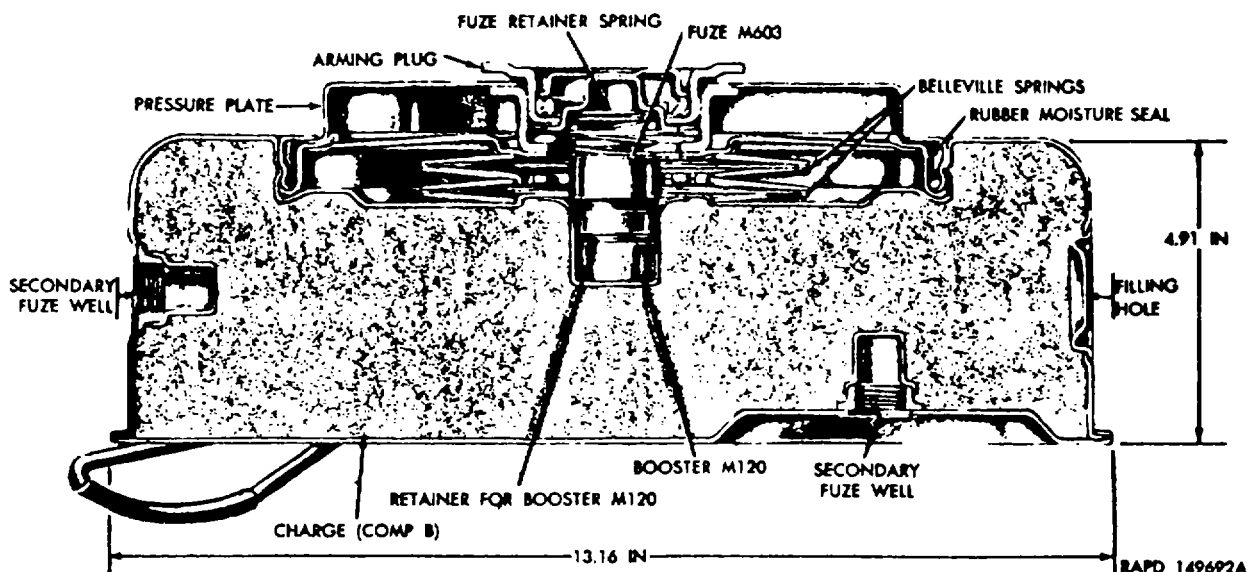

Figure 7-6. Heavy AT mine, with fuze installed – cross section.

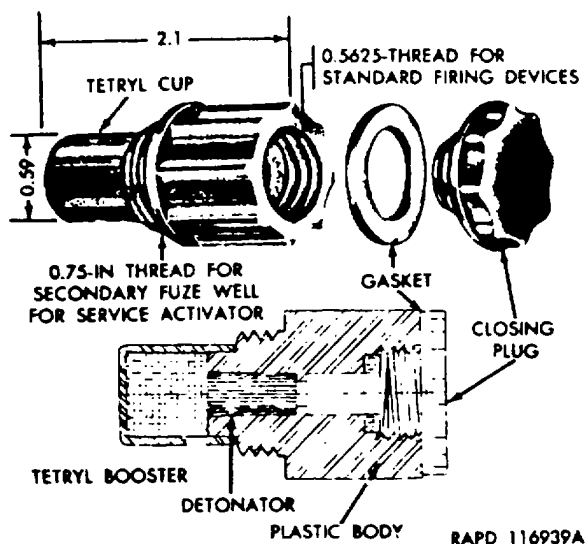

Figure 7-7. AT mine activator.

7-6. Practice AT Mines

a. *General.* Practice AT mines are of the same size, shape, weight and casing material as the service mines they simulate. These practice mines contain no high explosive. However, they do contain small smoke-puff and noisemaking charges of low explosive (black powder or pyrotechnic composition) to simulate explosion of the service mine. Practice mines are used for training in identification, care, handling and use of service AT mines.

b. *Fuzes.* Practice mines are fitted with fuzes which contain igniter charges and a smoke composition. The fuze functions like the service fuze. However, in the practice fuze, the igniter charge ignites the smoke composition. This explodes, emitting a cloud of smoke and creating a noise.

c. *Types.* Practice mines simulate the two basic service types: heavy metallic and light. Representative heavy and light types are illustrated in figures 7-11 and 7-12.

7-7. Boobytrapping and Improvisation

a. *Boobytrapping AT Mine.* A boobytrapping AT mine equipped with an anti-removal device (fig. 7-13) is one that, in addition to its main fuze, is fitted with one or more secondary fuzes. These are intended to act as an anti-lift device and to cause the mine to explode when an attempt is

are capable of tank armor penetration. Deployment of the pressure-actuated tape in a plane perpendicular to the line of target travel will activate the mine against wheeled or tracked vehicles. Deployment of the tape at a slight angle (about 15°) to the perpendicular will activate the mine only against tracked vehicles. This allows for a degree of target discrimination.

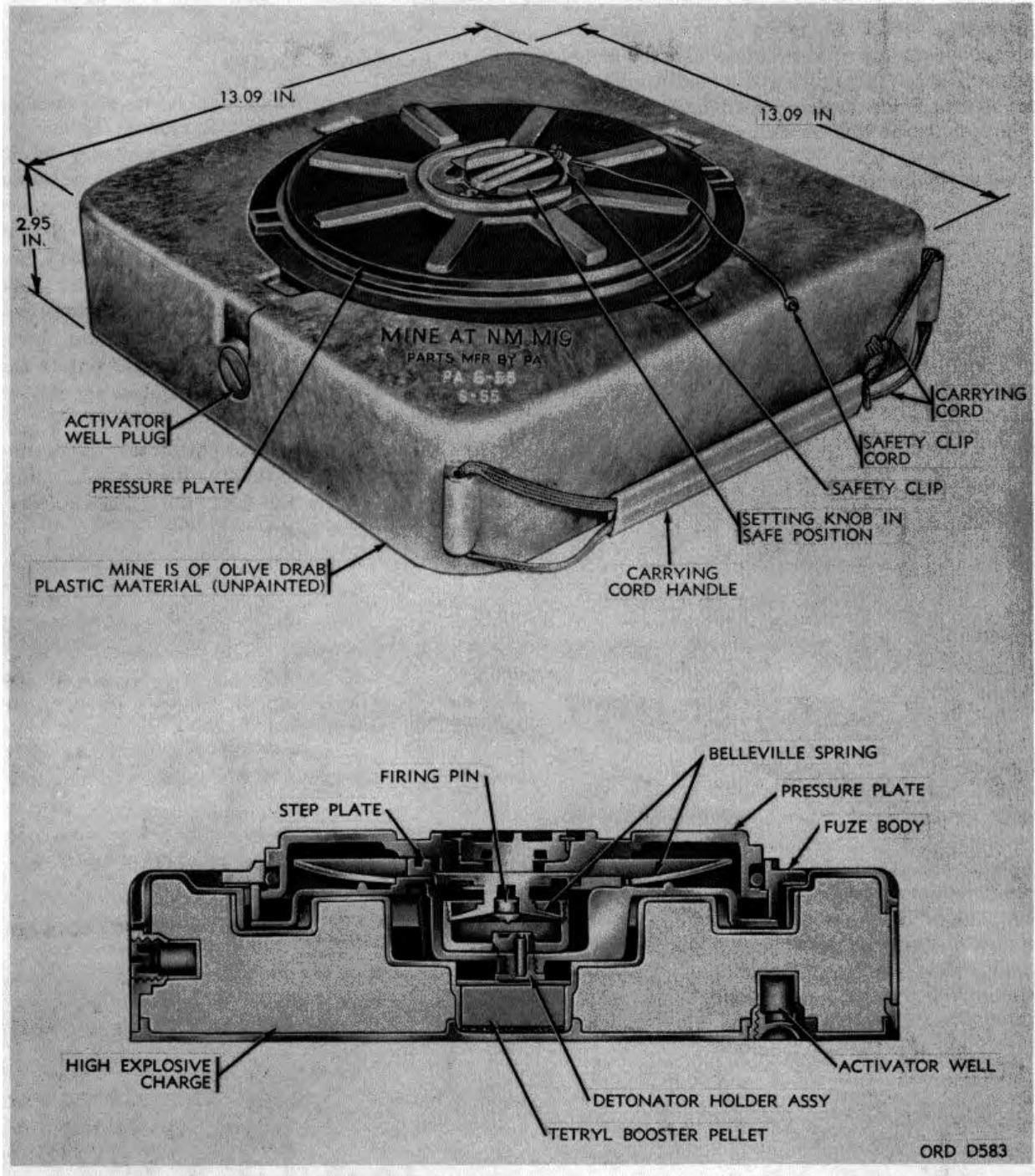

Figure 7-8. Nonmetallic AT mine and fuze.

made by the enemy to remove the mine. In the case of heavy service or practice AT mines, a secondary fuze consists of a firing device (para 7-9) and the appropriate activator (fig. 7-7). In the case of a light service or practice AT mine, a secondary fuze consists of a firing device fitted with a non-electric blasting cap. Secondary fuzes may be

fitted to an AT mine or to another mine or explosive charge laid beneath or beside it. Mines or charges and firing devices in such an arrangement are connected by wires and so laid as to avoid detection. Thus, attempted removal by an unsuspecting enemy causes the whole arrangement to explode.

b. *Improvisation.* All types of land mines are subject to a variety of improvised uses: in combination with each other; with all types of explosive charges and firing devices; with bombs or artillery projectiles or with dummy mines.

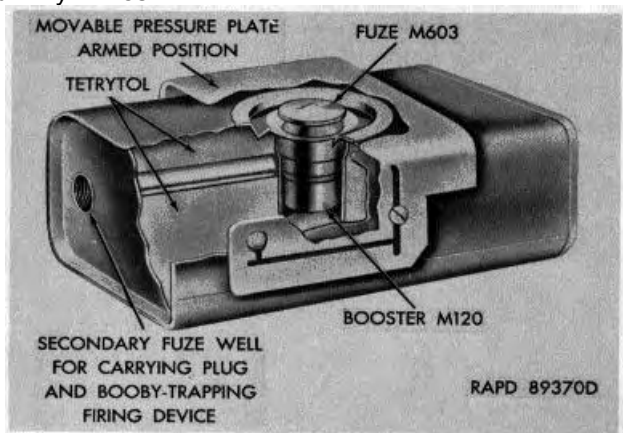

Figure 7-9. Light AT mine and fuze.

7-8. Chemical Mines and Incendiary Bursters

a. *Chemical Mines.* Chemical mines are used for contaminating purposes. Exploded either by remote control or by trip action, these mines spread chemical agents in either liquid or vapor form.

(1) One type of chemical mine, consisting of a rectangular, one-gallon metal can (fig. 7-1), has two short copper wires soldered to one of its sides. These wires are used for attaching a burster (detonating cord). The mine contains a liquid chemical agent. Functioning of the burster bursts the mine (can) and disperses the chemical agent over a wide area.

(2) The second type of chemical mine is similar in appearance and functioning to an AT mine. When activated by the fuze, the mine explodes, spreading a nerve agent.

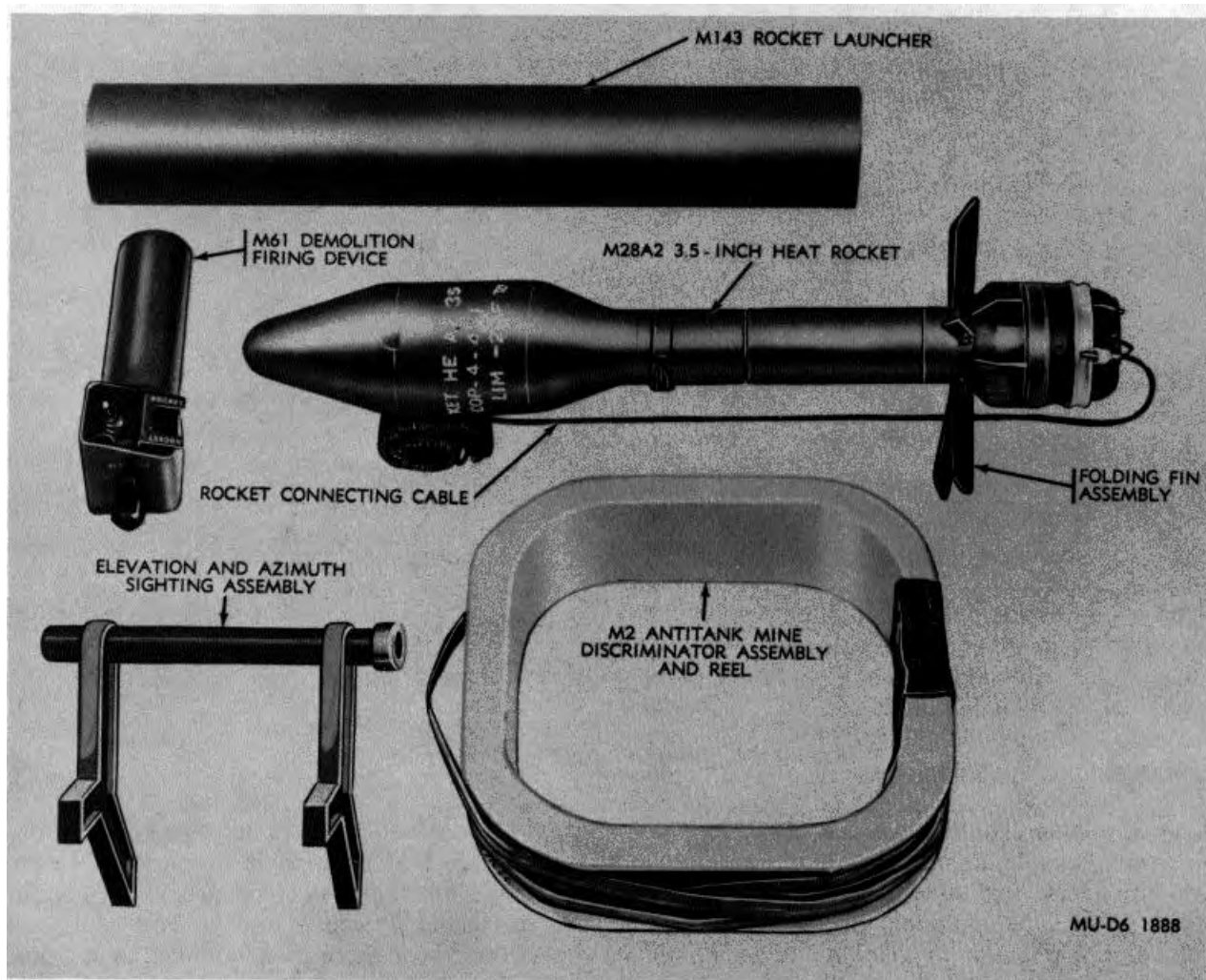

Figure 7-10. Off-route AT mine.

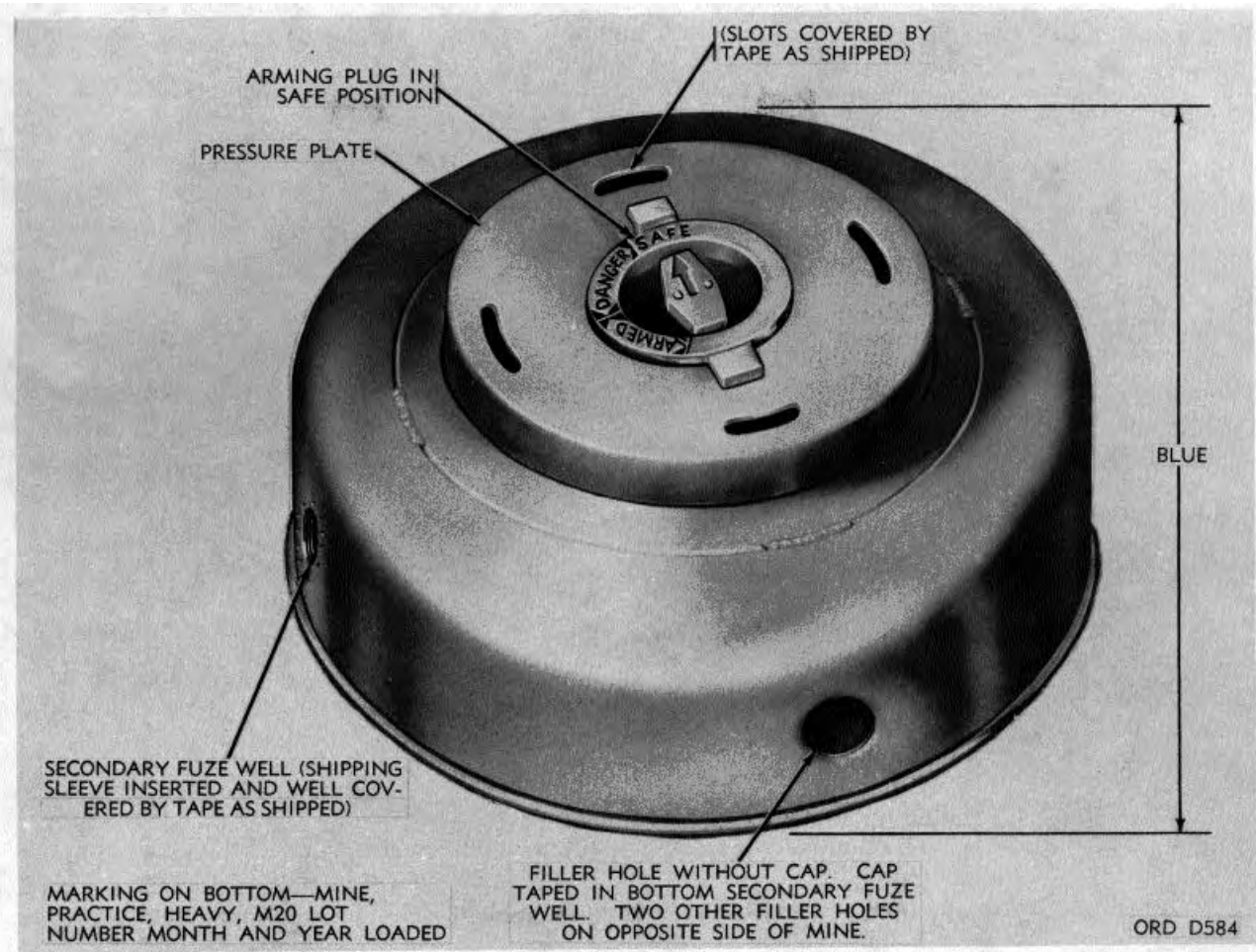

Figure 7-11. Practice heavy AT mine.

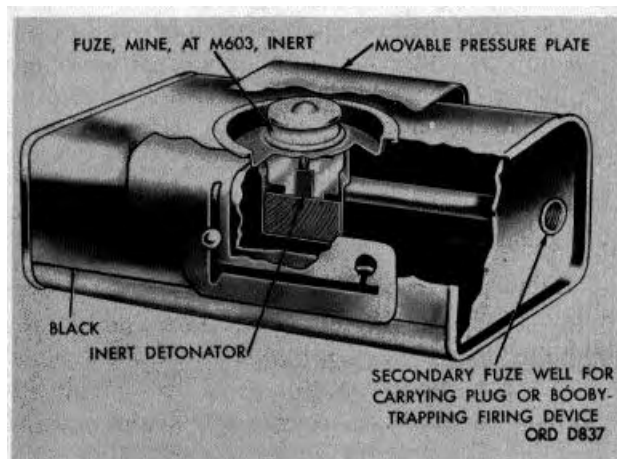

Figure 7-12. Inert light AT mine and inert fuze.



Figure 7-13. Installation of a boobytrapped AT mine.

b. *Incendiary Burster*. An incendiary burster (fig. 7-14) is used, primarily, with field-improvised incendiary munitions. When immersed in a container (5-gallon can, used shell case, 55-gallon drum) filled with thickened fuel, the burster will

rupture the container and scatter flaming fuel over a large area. The burster can be fired either electrically or mechanically: by fuze, blasting cap, detonating cord or any standard boobytrap firing device.

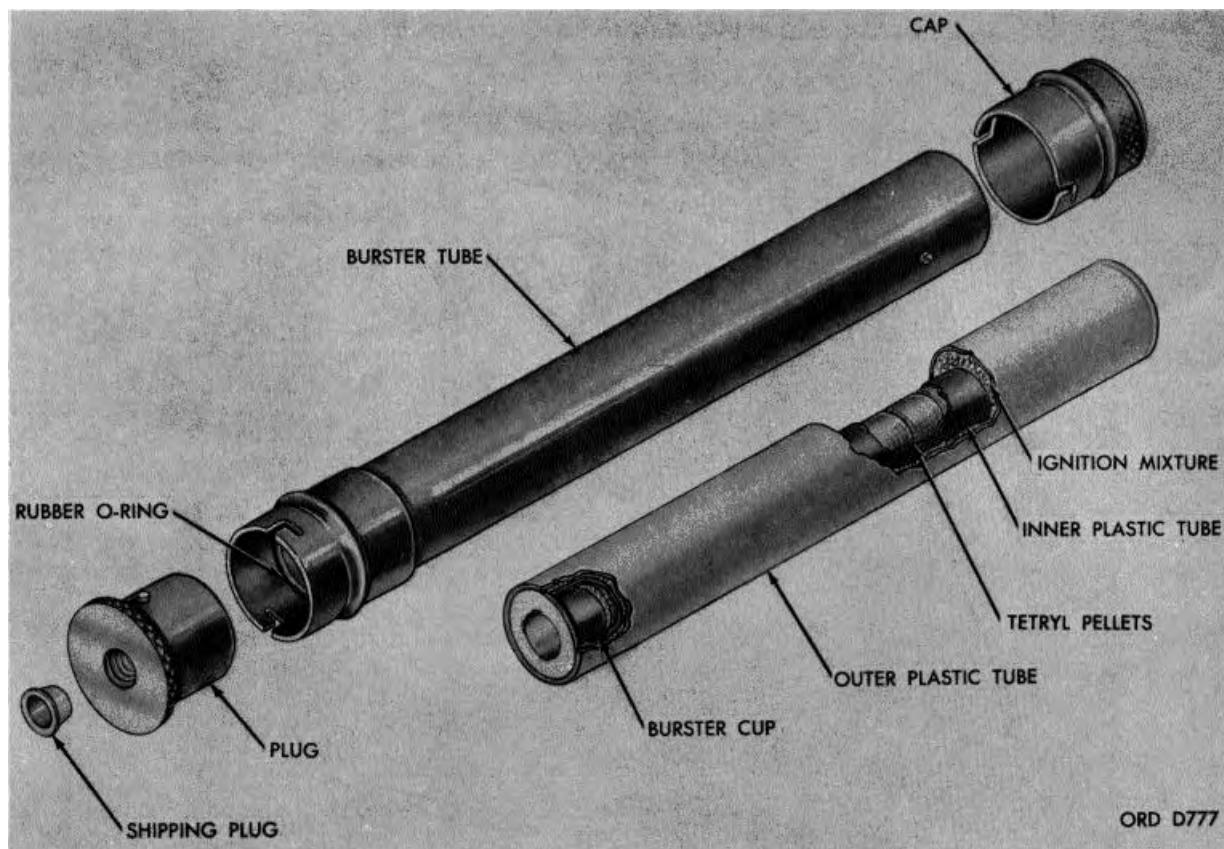

Figure 7-14. Incendiary burster.

7-9. Firing Devices

A firing device is used to initiate a train of fire for detonation of demolition charges, boobytraps or mines usually, but not necessarily, as part of a nonelectric system. A firing device is a separate item of issue. It must be requisitioned separately from land mines, or from demolition charges, which are used for making improvised land mines. Firing devices are of two general shapes: tubular and box. Initiating actions for firing devices are shown in figure 7,15. When a firing device is used as a secondary fuze for boobytrapping heavy AT mines, a blasting cap is not used. The base coupling of the firing device is threaded directly into a secondary fuze well of the mine into which an activator has been assembled. When a firing device is used with APERS mines or light AT mines, a blasting cap is used with the firing device. Inert devices are provided for training.

7-10. Care and Precautions in Handling

Laying APERS and AT mines and installing anti-removal devices, boobytrapping and improvisations are specialized operations performed only by

well trained troops. All types of mines must be handled with care at all times.

a. As fuzes, primers, detonators, activators and firing devices contain particularly sensitive explosives, protect boxes containing these items against shock, friction and high temperatures. Ground to prevent accumulation of static electricity.

b. Protect mines and components in their packings against moisture.

c. Raise packed mines stacked in the open on dunnage. Cover with double thickness of paulin. Leave enough space all around stack for circulation of air. Support paulins so as to provide 12inch space between top layer of mines and paulins.

d. Do not open packing boxes containing mines or components within 100 feet of any magazine, or at any ammunition dump. Preferably, in unpacking and repacking operations, use safety non-sparking tools made of copper or wood.

e. Do not remove safety pins, safety forks, safety clips and similar devices for preventing initiation of mine while being handled, until just

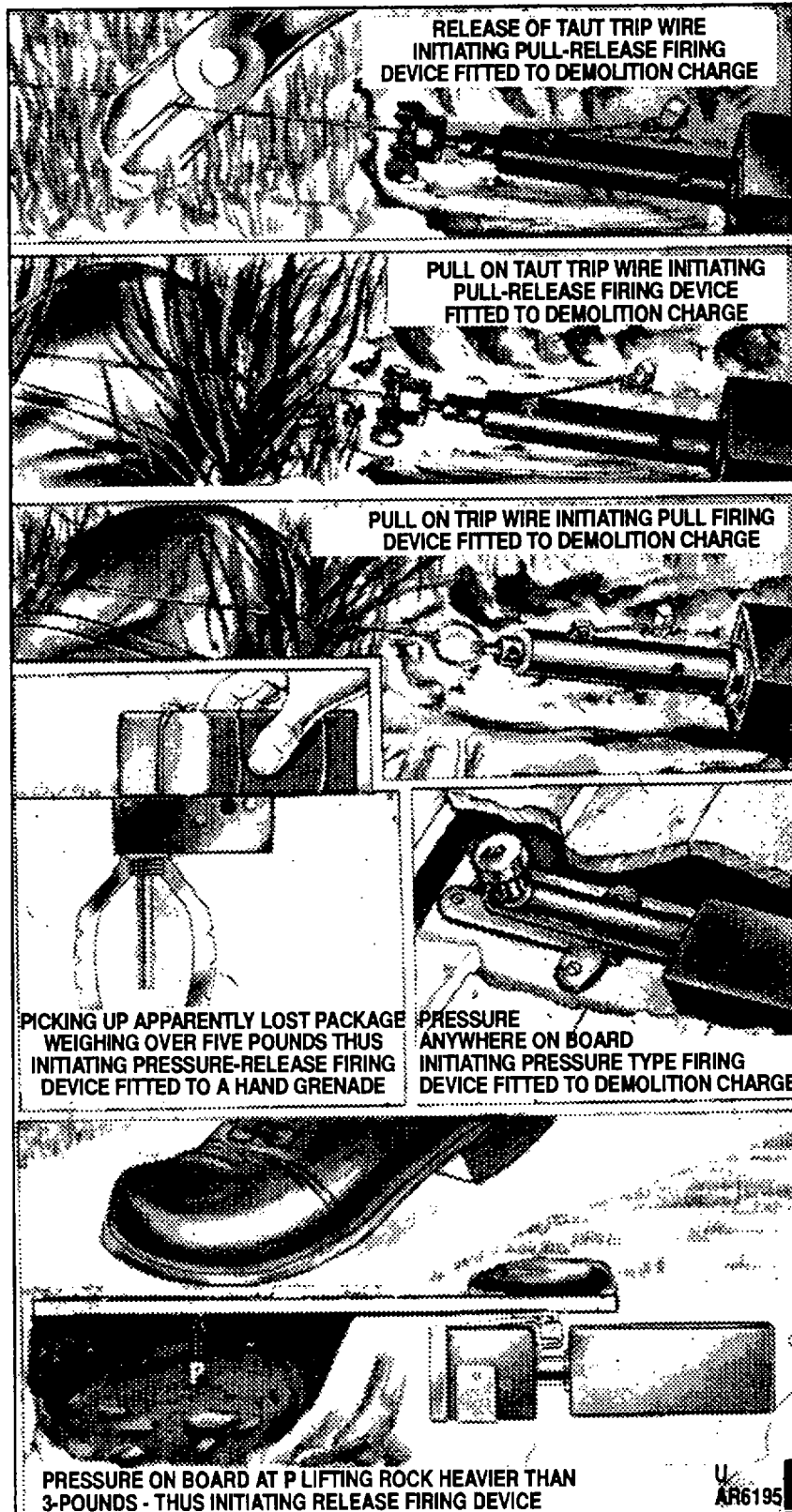
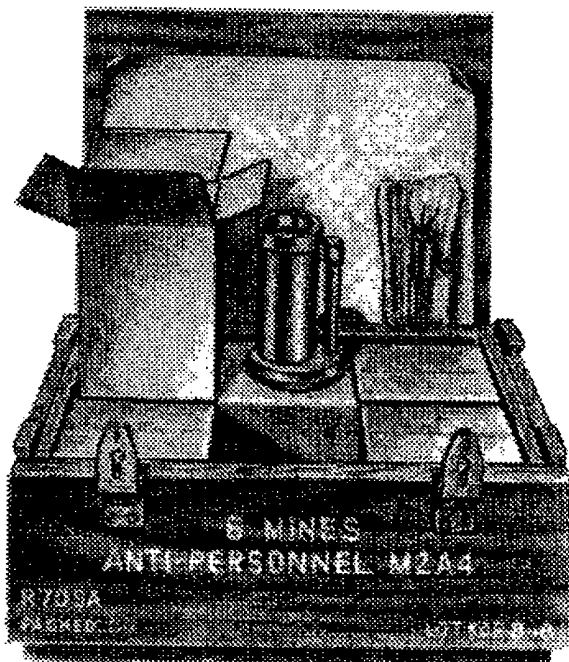
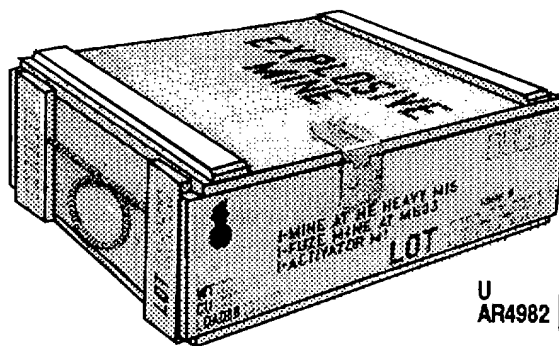

Figure 7-15. Representative methods of using firing devices in boobytrap installation.



U
AR6182

Figure 7-16. Packing box for an APERS mine.



U
AR4982

Figure 7-18. Heavy AT mine as shipped.

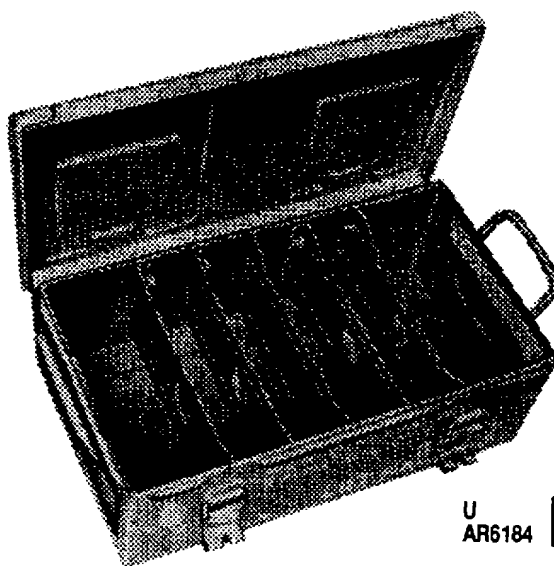

U
AR6184

Figure 7-19. Metal packing box for 8 AT mines and 8 AT mine fuzes or 12 light AT practice mines without fuze.

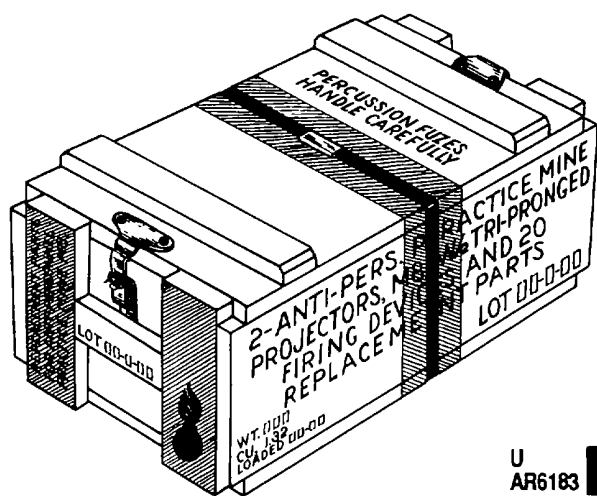

U
AR6183

Figure 7-17. Packing box for an APERS practice mine and replacement parts.

before arming. In disarming armed mines, restore safety devices, as prescribed in TM 9-1345-20312&P and FM 20-32.

f. In employment of inert mines for training in handling, and of practice mines for simulating actual service conditions, observe rules, regulations and precautions that pertain to high-explosive service mines.

7-11. Packing and Marking

a. *APERS Mines.* Bounding APERS mines are packed with fuzes and spools of steel wire in cartons. The cartons are overpacked in wooden boxes stained light brown, with marking in yellow, or unstained, with marking in black (fig. 7-16). Nonmetallic APERS mines are packed in cartons overpacked in wooden boxes which also contain detonators and wrenches. Practice APERS mines are packed in wooden boxes which have markings in black, a blue center band and blue vertical end cleats, or in unpainted boxes, with markings in black (fig. 7-17).

b. *AT Mines.* AT mines, together with fuzes and activators each in individual metal containers, are packed in wooden boxes (fig. 7-18). Wooden boxes

containing high-explosive mines are stained light brown, with markings in yellow, or are unstained, with markings in black. Metal boxes are painted olive drab, with markings in yellow. Practice AT mines (fig. 7-19), together with fuzes in individual metal containers, are packed in wooden

boxes. Boxes are painted with a blue band around the center and have blue cleats on the ends. Both service and practice activators are also packed, each in an individual metal container, in wooden boxes. Inert mines without fuzes and without activators are packed in wooden boxes.

CHAPTER 8 DEMOLITION MATERIALS

8-1. General

a. The term, demolition materials, covers a variety of explosive charges and related equipment. It also includes initiating devices and other explosive and nonexplosive equipment. These materials function in destruction of earthworks, fortifications, railroads, dams, bridges and buildings, and in excavation for construction projects. Demolition materials are also employed to clear mine fields. For the convenience of military units performing, or in training for demolition work, certain demolition materials are grouped into kits and mine-clearing devices.

b. Demolition materials, components, auxiliary items and kits for service and training, together with packing data, are listed in SC 1340/98-IL. For complete technical information on demolition materials, see TM 9-1375-213-12, TM 9-1375-21334 and TM 43-0001-38. For tactical information pertaining to demolition materials, see FM 5-250.

8-2. Classification

Demolition materials are classified according to composition as explosive or nonexplosive; according to use, as service or training; and according to type, as demolition charges, priming and initiating material, demolition equipment kits and mine-clearing devices.

a. *Demolition Charges.* These consist of high explosives in various sizes and shapes. They are used as the main charge with certain detonating devices, as in the case of demolition blocks or commercial dynamite sticks for general demolition. They are also used in the form of charges for special mechanical apparatus, such as mineclearing devices.

b. *Priming and Initiating Materials.* These consist of explosive and nonexplosive, electric and mechanical equipment and accessories. They are used to initiate demolition charges.

c. *Demolition Equipment Kits.* These kits are made up of selected explosive and nonexplosive

items, containers and carrying attachments. They are intended for special demolition tasks. Demolition training kits are designed for such demolition operations as mine-field clearing or preparation of excavations.

d. *Mine-Clearing Devices.* These are long, slender explosive charges which are projected into minefields and detonated in order to clear a path through the field.

Two basic types are used:

(1) *Rocket-towed line charge.* This is a flexible line charge towed out over the mine field by rocket, and allowed to fall onto the field.

(2) *Demolition projected charge (snake).* This is a long, semirigid metal-encased charge. It is assembled on the edge of the minefield and pushed out onto the field by tank.

8-3. Demolition Charges

These charges are used in general demolition operations, such as cutting, breaching and cratering. They are composed of high-velocity explosives RDX, PETN, amatol, composition B, composition C series, tetrytol and TNT, and the low-velocity explosive ammonium nitrate. Most charges are made in the form of rectangular blocks. Some are made in cylindrical form, such as the 1/4-pound TNT charge. Recent studies show that a thinner layer of explosive spread out over a larger area is more efficient than a thick block of the same weight. In line with these studies, newer demolition charges are thinner than the older charges and are fitted with pressure-sensitive adhesive on one side for quick emplacement on practically any surface.

a. *Cutting and Breaching Types.*

(1) *Tetrytol blocks.* These blocks (fig. 8-1), composed of 75 percent tetryl and 25 percent TNT, have a threaded cap well in each end and a tetryl booster pellet. The threaded cap well is designed to receive a detonator, a primed firing device, or a priming adapter with an electric or nonelectric blasting cap. Tetrytol blocks are effec-

U
AR4983

Figure 8-1. Tetrytol demolition block.

tive as a cutting or breaching charge but not as a cratering charge. Tetrytol is only slightly soluble in water. It is brittle and breaks very easily. Each block is wrapped in olive-drab, asphalt-impregnated paper.

(2) *Composition C2 or CS blocks.* These blocks (fig. 8-2) are plastic explosives. They may be molded at temperatures between -20°F. and $+125^{\circ}\text{F.}$ Although composition charges are difficult to mold at temperatures below freezing, body heat can keep the material pliable. Gases emitted, however, under these conditions, cause sickening headaches. Plasticity of the material permits it to be molded by hand, like putty; confinement of the material, as in the case of packing it into irregular-shaped objects, gives it high demolition efficiency. Insoluble in water, block demolition charges of composition C2 and C3 are suitable for underwater demolition. Initiation may be by detonating cord tied in a double knot, with the plastic explosive molded into a ball around the knot or by a special blasting cap inserted into the explosive.

(3) *Composition C4 blocks.* Composition C4 has many advantages over composition C3: It is more powerful; it may be molded over a broader range of temperatures (-70°F. to $+170^{\circ}\text{F.}$); it is more stable, less sticky and will not adhere to

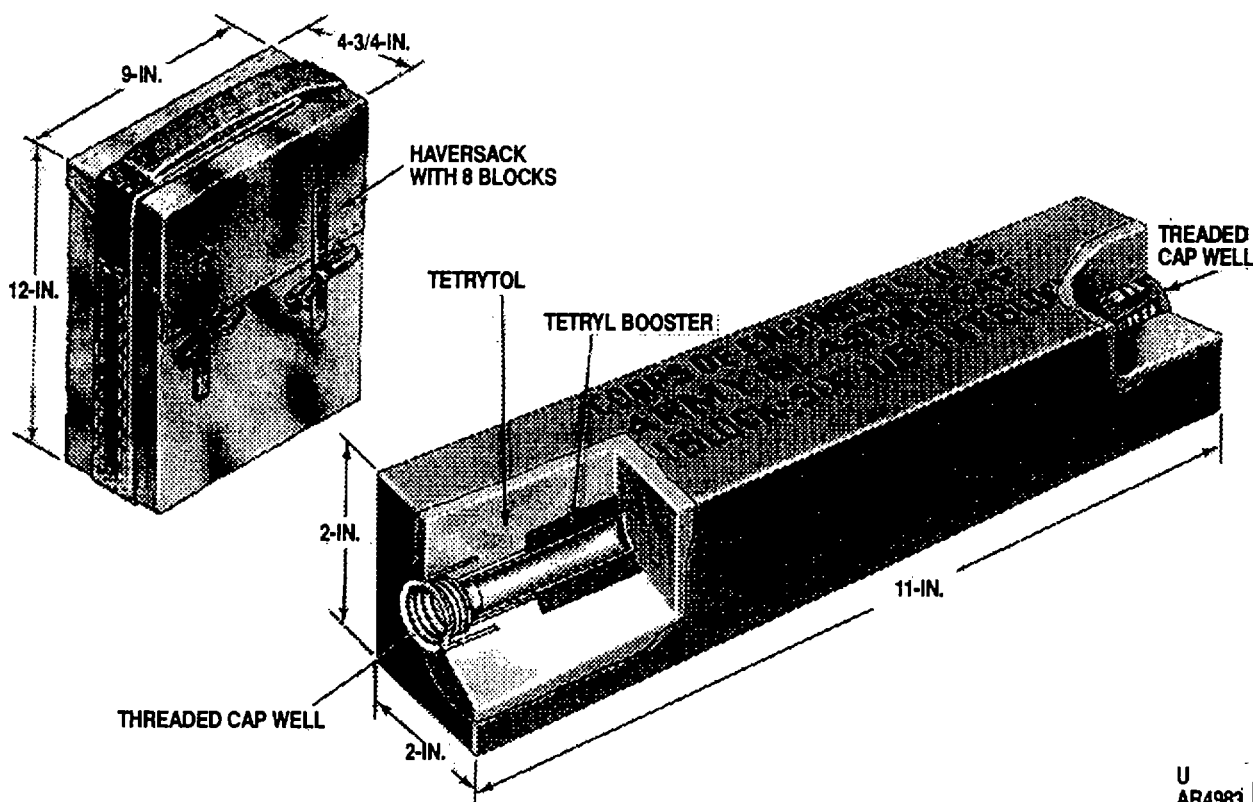
hands; and it is less subject to water erosion when used for underwater work. This explosive is issued in thin blocks (fig. 8-3) or packed in white plastic containers with a threaded cap well in each end.

(4) TNT blocks. Trinitrotoluene (TNT) is one of the most powerful of military explosives. It has a high detonating velocity and is therefore used in general demolitions for cutting and breaching. It can be burned in the open in small quantities without exploding. It is relatively insensitive to shock. TNT is insoluble in water and can be used in underwater charges. TNT block demolition charges are available in three sizes: 1/4 pound, 1/2 pound and 1 pound. The 1/4-pound block demolition charge is issued in a cylindrical, olive-drab, plastic container. The 1/2-pound and 1-pound charges are issued in rectangular, olivedrab, plastic containers. All three have threaded cap wells at one end to receive detonators, primed firing devices, and priming adapters with electric or nonelectric special blasting caps.

b. Cratering Type. Ammonium nitrate or H-6 blocks (fig. 8-4) are used for cratering operations. Ammonium nitrate is the least sensitive of military explosives. It has a low detonating velocity and is,

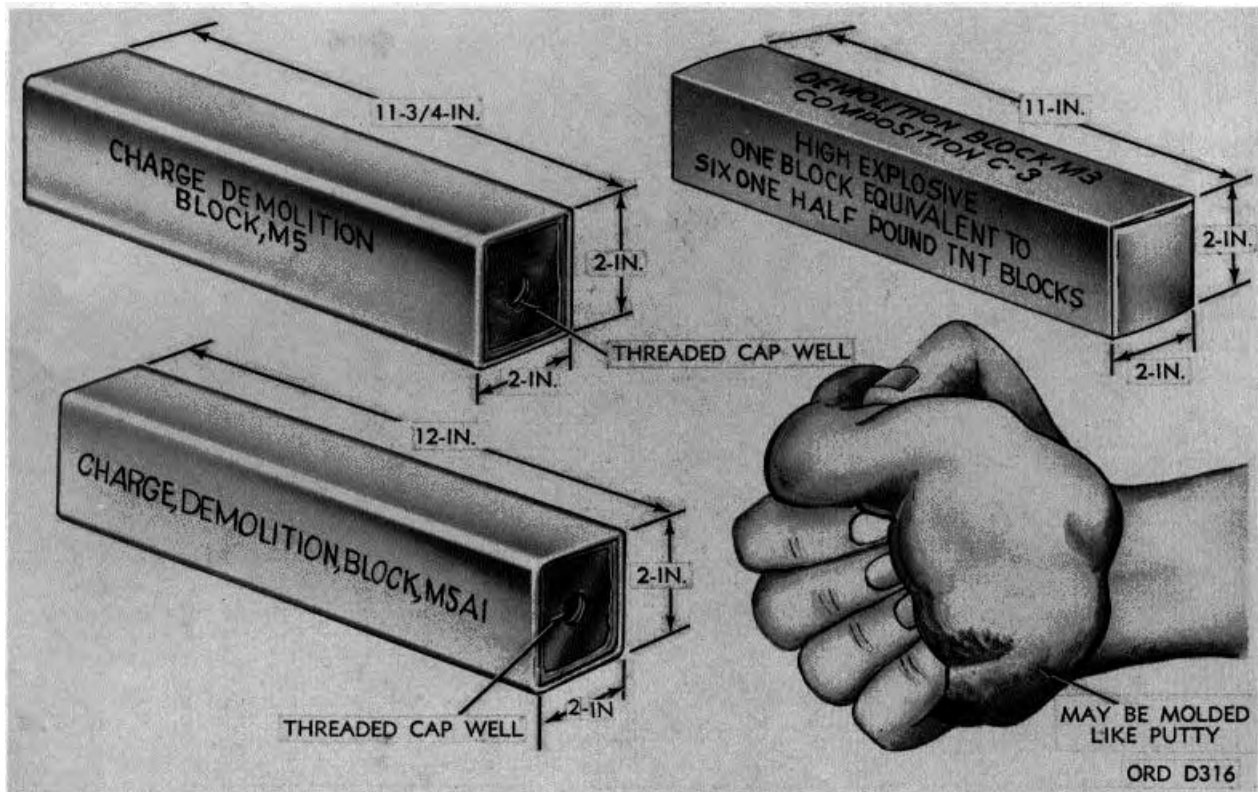

Figure 8-2. Plastic demolition charges.

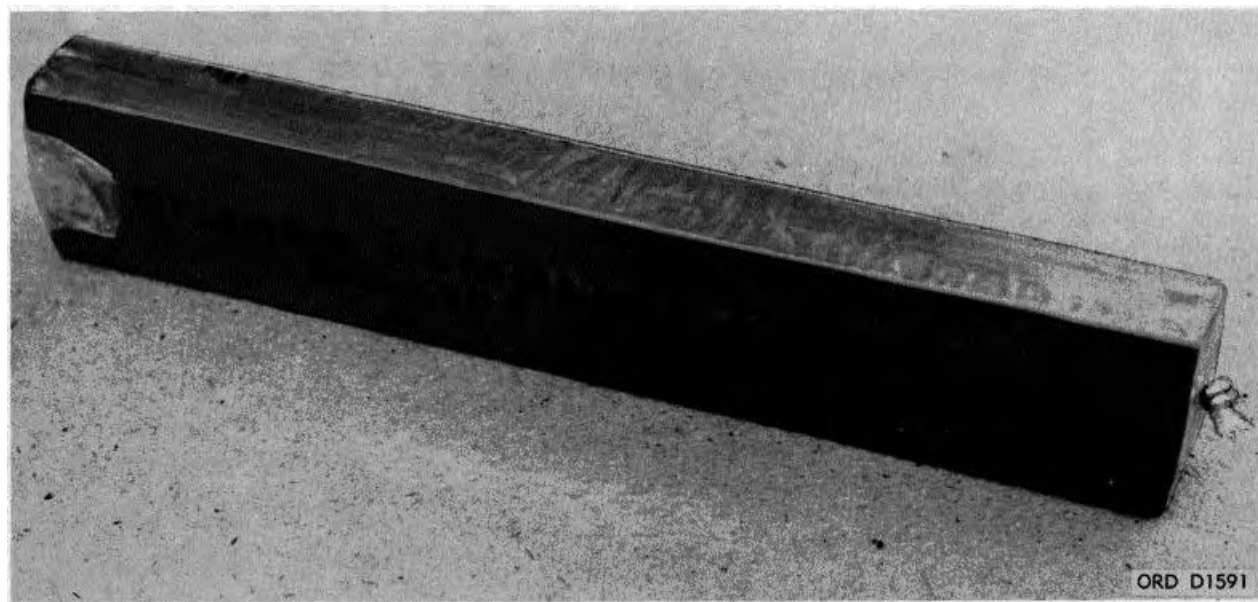

Figure 8-3. Composition C4 block charge.

therefore, unsuitable for cutting and breaching. However, the low detonating velocity produces a pushing or heaving effect. This makes it well suited for cratering and ditching operations.

c. *Shaped Demolition Charges.* These charges consist of cylindrical blocks of high explosive. They have a conical or hemispherical, metal-lined cavity in one end, and a conical shape with

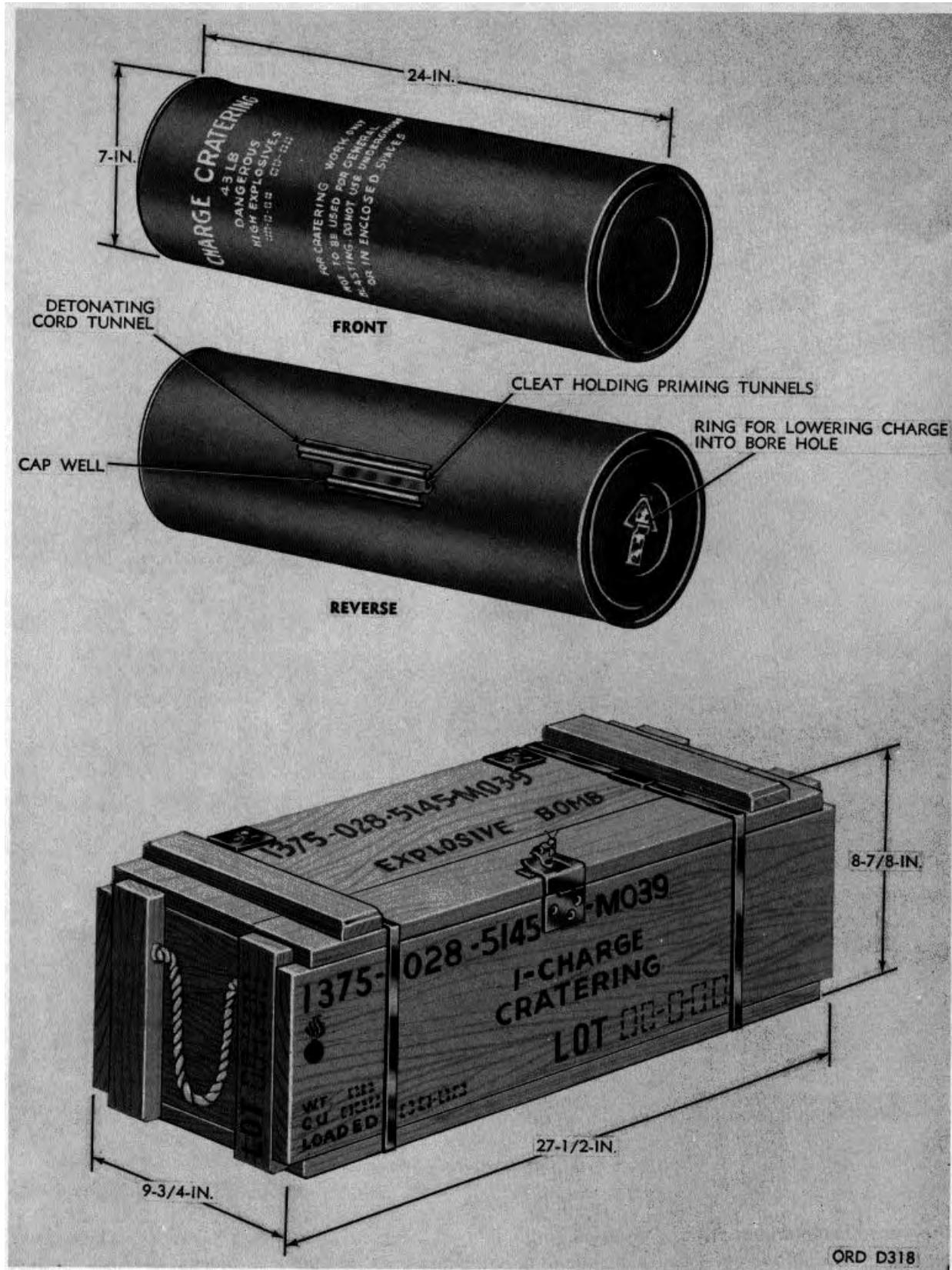

Figure 8-4. Cratering-type block demolition charge.

blasting cap well at the other end. Detonation of the charge starts at the cap well and travels to the cavity. There, the detonation wave is focused to produce a narrow concentrated detonation jet. This results in penetration greater than that produced without the cavity. With this effect, called Munroe effect, boreholes can be blasted in steel, concrete and similar material. Maximum penetration of a shaped charge is obtained when it is exploded at a certain characteristic distance, called standoff, from its target. Standoff is provided for by a fiber sleeve or metal legs supporting the charge at the time of firing. See TM 9-1375-200 for precautions in use of shaped charges.

(1) *15-Pound shaped demolition charge.* This charge (fig. 8-5) consists of an explosive charge of Composition B and a 50/50 pentolite booster in a moisture-resistant fiber container. The top of the charge has a threaded cap well for receiving a blasting cap and adapter or any standard firing device. A cylindrical fiber base slips on the end of the charge to hold the charge at the proper standoff distance. The cavity liner is a cone of highdensity glass. This charge will pierce 36 inches of reinforced concrete. In a wall of greater thickness, it will produce a hole 30 inches deep and 2 to 3 1/2 inches in diameter.

(2) *40-Pound shaped demolition charge.*

This charge (fig. 86) consists of a larger quantity of Composition B than the 15-pound charge, and a 50/50 pentolite booster in a metal container. The cavity liner is made of metal. A threaded cap well is provided for receiving a blasting cap and adapter or any standard firing device. A metal tripod for gaging correct standoff distance is shipped unassembled, nested with the charge in the same container. This charge will penetrate 60 inches of reinforced concrete, producing a hole tapering from 5 inches to 2 1/2 inches in diameter.

(3) *Shaped demolition charge containers.* These containers are used in opening explosive-

filled ordnance by initiating low-order detonation. When containers are filled with plastic explosive, the liners mold the explosive to produce a shaped charge. Shaped demolition charge containers, available in several shapes and sizes, are designed for various types of operations.

d. *Dynamite.* Dynamite, the most common com-



Figure 8-6. 40-Pound shaped demolition charge.



Figure 8-5. 15-Pound shaped demolition charge.

mercial high explosive, may be one of several types: straight dynamite, ammonia dynamite, ammonia gelatin dynamite and gelatin dynamite. These types are produced in various grades designated by a weight-strength marking expressed as a percentage. Dynamite is exploded by a No. 6 (or larger) commercial blasting cap or by military blasting caps termed Special. Dynamite is normally issued in paraffin-treated paper cartridges (also called sticks), packed 50 pounds per wooden box. The standard cartridge size is 1 1/4 inches in diameter by 8 inches long. The number of cartridges per box varies in inverse proportion to the density of the particular type and grade of dynamite. A cartridge of 40-percent dynamite for example, 1 1/4 inches in diameter by 8 inches long, weighs approximately 1/2 pound.

(1) *Straight dynamite.* The percentage designation of straight dynamite is the percent, by weight, of nitroglycerin it contains. (In other than straight dynamite, the percentage indicates equal strength, weight for weight, with straight dynamite containing that percent of nitroglycerin.) Straight dynamite consists of nitroglycerin absorbed in a porous material that contains other energy-producing ingredients. Increasing the percent of nitroglycerin decreases the amount of other energy-producing ingredients. Hence, the actual blasting power of the dynamite does not increase directly with an increase in the percentage designation. Fifty to sixty percent straight dynamite is roughly equivalent to TNT and may be substituted for it. This dynamite does not resist water as well as TNT, but may be used under water if fired within 24 hours after submersion.

(2) *Ammonia dynamite.* In ammonia dynamite, part of the nitroglycerin is replaced by ammonium nitrate. This change in composition results in less poisonous fumes, less fragmentation and less water resistance than for straight dynamite of the same strength. Ammonia dynamite is not satisfactory for underwater use.

(3) *Ammonia gelatin dynamite.* This is a plastic dynamite that has an explosive base of nitrocotton dissolved in nitroglycerin with ammonium nitrate added. It produces less poisonous fumes than straight dynamite, which it equals in water resistance.

(5) *Gelatin dynamite.* This dynamite is a plastic type that has an explosive base of nitrocotton dissolved in nitroglycerin. It is insoluble in water. Its high velocity, when confined, produces a quick, shattering action. It is used for submarine blasting and blasting in extremely hard rock.

8-4. Priming and Initiating Materials

These materials comprise the initiating and priming components, accessories and tools used in conjunction with demolition charges. The variety of initiating and priming components and accessories available permits considerable flexibility in the design of demolition rounds. Thus, specific demolition projects may be accomplished with the efficiency and safety appropriate to the tactical situation.

a. *Initiating Component.* The initiating component is that component which receives the initiating action, such as a pull on a fuse igniter. Initiating components include time blasting fuse and igniters, firing devices and blasting machines. Detonators combine functions of initiating and priming components.

b. *Priming Component.* The priming component is that component which receives the action initiated by the initiating component. The action may be a flame or an electrical impulse. Priming components include destructors, detonating cord and blasting caps.

8-5. Detonators

a. *General.* Detonators are explosive devices sensitive to mechanical initiation. They are used to detonate explosive charges. Detonators combine functions of firing devices and blasting caps in a single unit. They may or may not incorporate a time-delay mechanism. Detonators used in demolition work are classified according to initiating action as friction, percussion and concussion.

b. *Types.*

(1) *Delay friction type.* Delay friction detonators (fig. 8-7 and 8-8) consist of a cylindrical, olive-drab, plastic housing containing a pull wire coated with friction material. The pull wire is set in a flash compound. A tube set in the lower end of the housing contains either an 8-second or 15-second delay fuse. The tube also contains a small detonator charge about the size of a blasting cap. Markings on the surfaces of the delay housings and the type of pull rings distinguish the 8-second and 15-second delay detonators. The 8-second type has a T-shaped pull ring; the 15-second type has a circular pull ring. With the safety pin removed, pulling on the pull ring draws the coated wire through the flash compound. The flash ignites the delay fuse. At the end of the delay period, the burning fuse initiates the attached detonator charge.

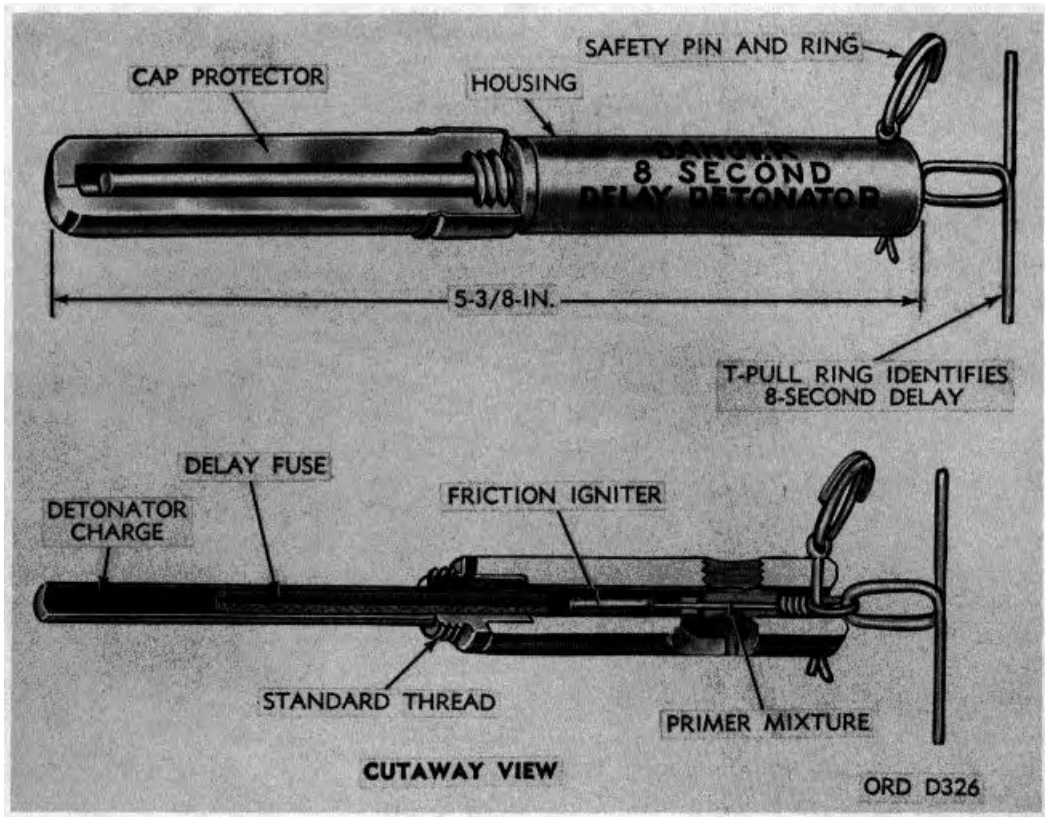

Figure 8-7. 8-Second delay friction detonator.

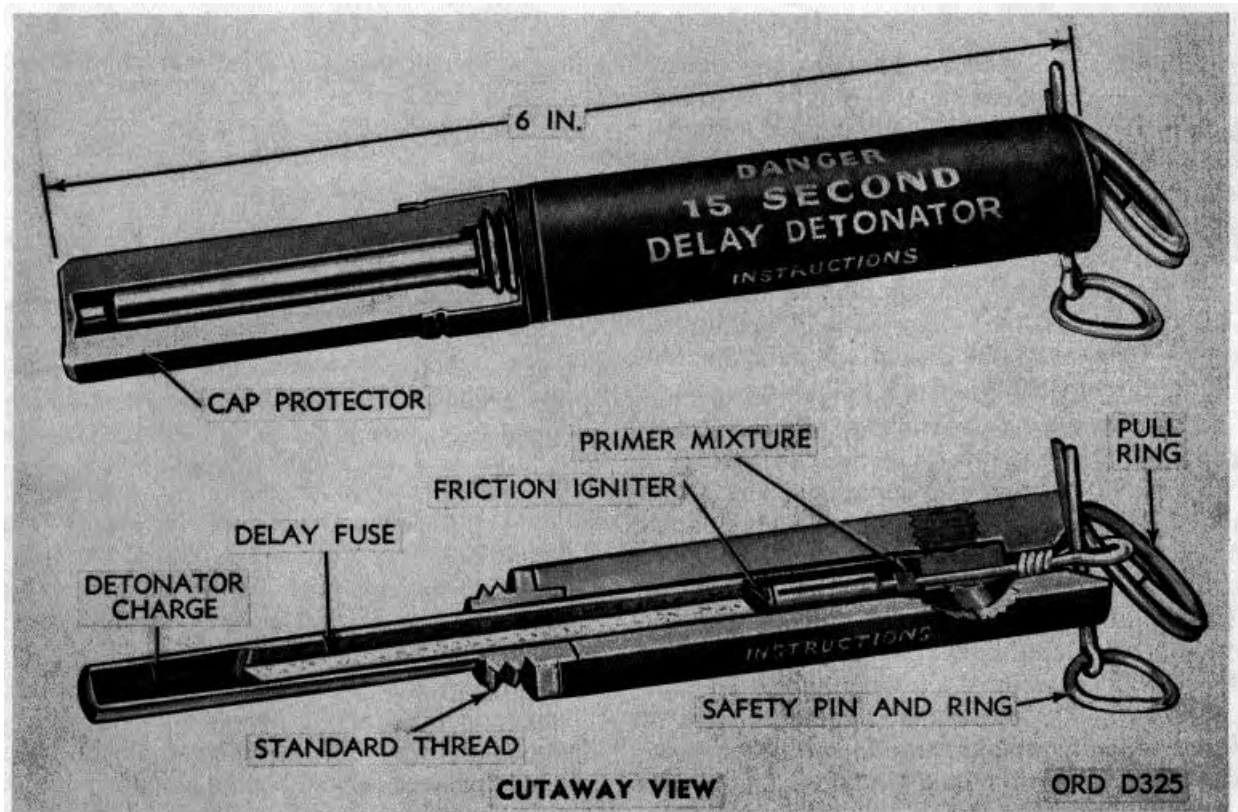

Figure 8-8. 15-Second delay friction detonator.

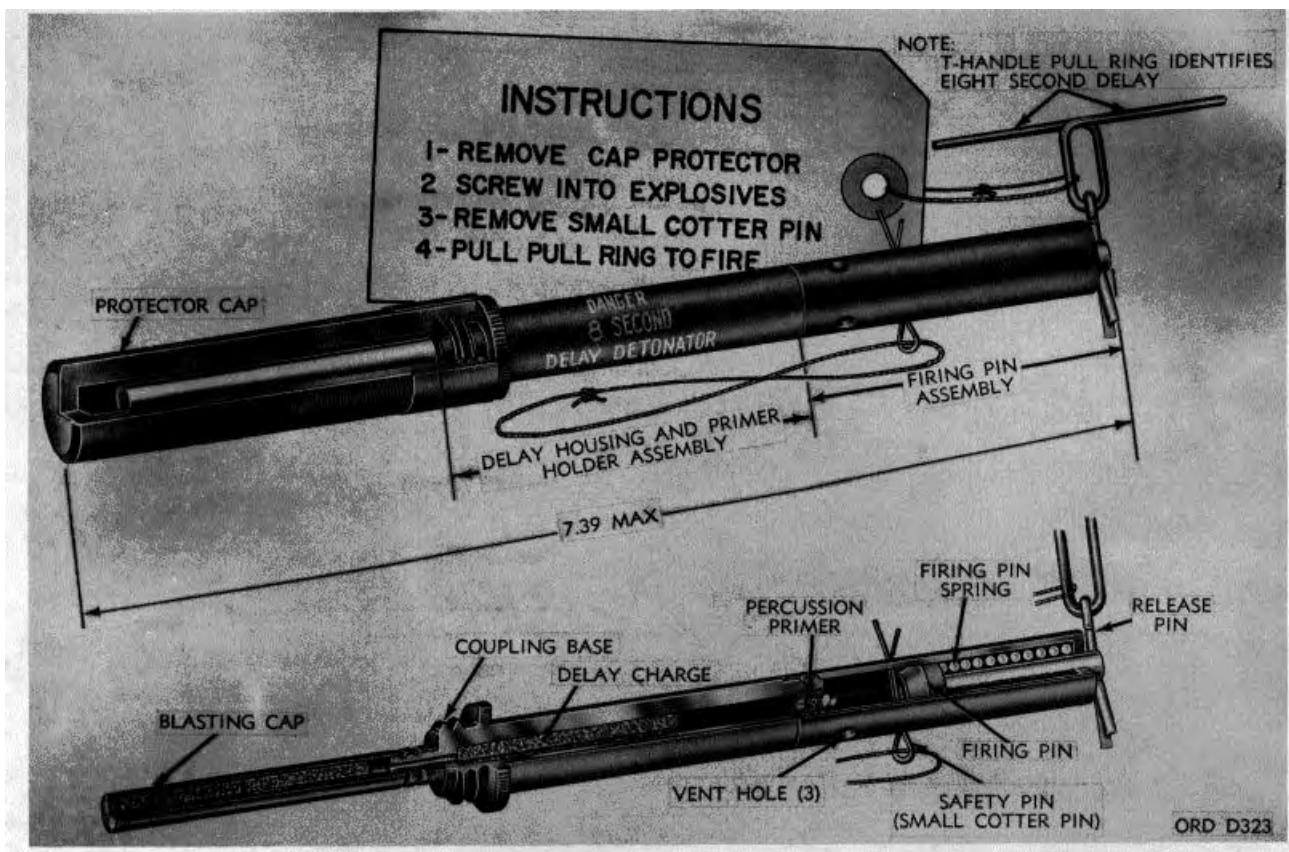

Figure 8-9. 8-Second delay percussion detonator.

(2) *Delay percussion type.* Delay percussion detonators (fig. 89 and 8-10) consist of a two-section cylindrical body with a firing pin assembly joined to a delay housing and primer assembly. A special blasting cap is crimped to an integral coupling base on one end of the delay and primer assembly. With the safety pin removed, a pull on the pull ring releases the firing pin. The firing pin strikes the percussion primer. The flame ignites the delay charge. At the end of the delay period, the burning delay charge fires the blasting cap.

(3) *Concussion detonator kit.* The concussion detonator kit is essentially a mechanical firing device with a blasting cap attached. The kit is actuated by a detonation wave from a high-explosive blast. Several demolition charges fitted with this type of firing device, in water or air, can be fired simultaneously when within range of the blast from an initiating charge or within range of each other. Demolition charges so fitted and placed need not be connected by detonating cord or other firing arrangements. A concussion wave strong enough to overcome the snap diaphragm causes the detonator, when armed, to function. For safety while arming the device in water, blue and yellow water-soluble, time-delay, salt tablets

are supplied with the detonator. The blue tablet gives a delay of approximately 31/2 minutes; the yellow, a delay of approximately 7 minutes.

8-6. Explosive Destructors

a. *General.* Explosive destructors are used to adapt ammunition and other explosive material, which cannot be reliably detonated by special blasting caps, for use in demolition work, boobytraps and improvised mines. Explosive destructors are also used to destroy deteriorated or abandoned ammunition.

b. *Types.*

(1) *Universal explosive destructor.* The universal explosive destructor (fig. 8-11) is a high explosive charge initiated by means of blasting caps or mine actuators and standard firing devices. The destructor is essentially an adapter booster with a threaded bushing that will fit in 1.5-, and 1.7-, and 2-inch standard, right-hand threaded fuze cavities. It is used in preparing loaded projectiles and bombs as improvised mines, boobytraps and demolition charges. It is also used by disposal units to destroy deteriorated or abandoned ammunition. The destructor is composed of

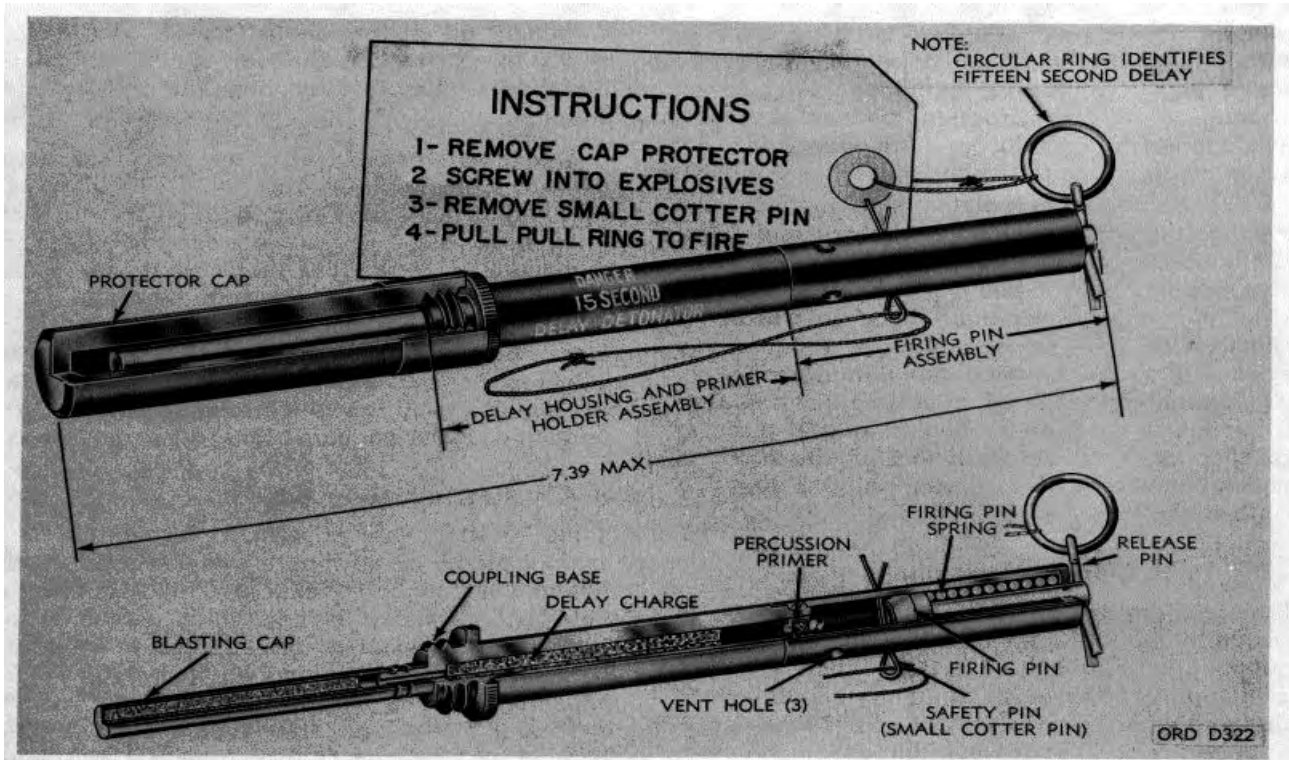

Figure 8-10. 15-Second delay percussion detonator

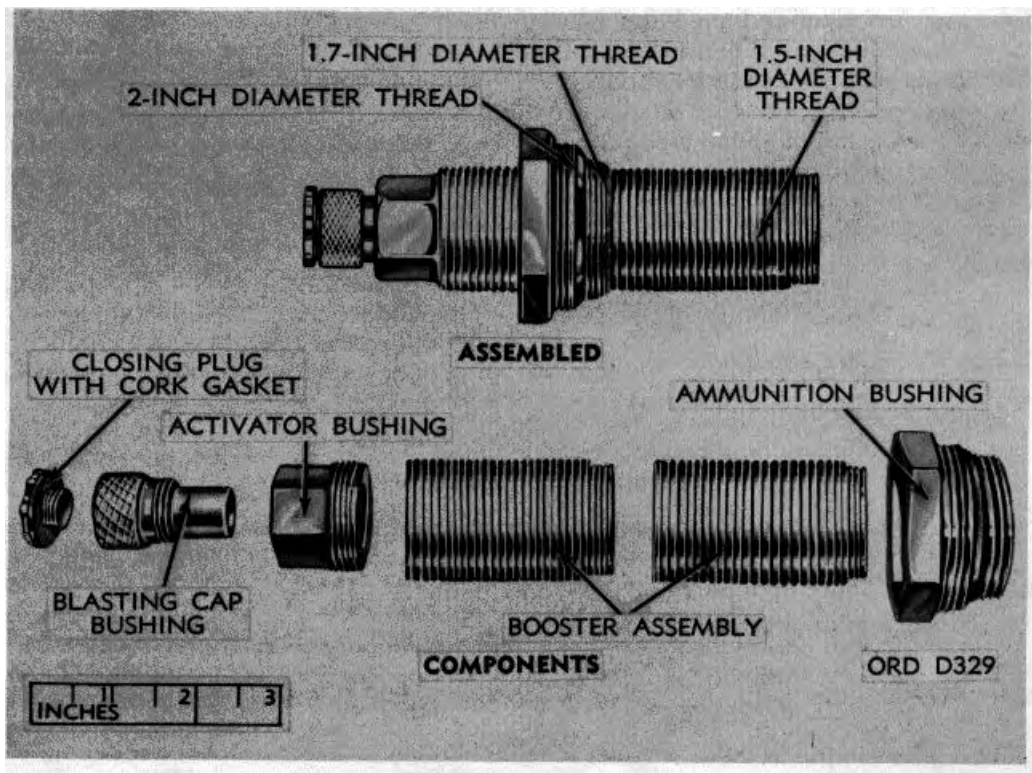

Figure 8-11. Universal explosive destructor

a plastic closing plug, standard priming adapter, blasting cap bushing, activator bushing, two booster cups (containing tetryl pellets) and an ammunition bushing. Booster cavities of bombs large projectiles should be filled completely by adding booster caps to the destructor, as required.

(2) *Explosive destructor.* The explosive destructor (fig. 8-12) consists of an explosive-filled, cylindrical body with a removable ogive. The ogive may be removed and discarded if not needed for a particular operation. This destructor is primed with a delay detonator, a delay firing device with special blasting cap, a nonelectric special blasting cap initiated with time blasting fuse or detonating cord, or an electric special blasting cap. The cap well, on each end of the body, is threaded to accept firing device coupling bases or priming adapters.

8-7. Time Blasting Fuse Igniters

These igniters are initiating components used in place of matches to light time blasting fuses. Fuse igniters are usually more reliable than matches. Use of igniters, therefore, is almost mandatory in rainy and windy weather. Fuse igniters consist of two types: friction and weatherproof.

a. *Friction type.* A friction, time-blasting, fuse igniter (fig. 8-13) consists of a paper tube containing friction powder. Prongs inside the open end of the fuse igniter permit the time-blasting fuse to be inserted but prevent removal, except by force. A pull on the loop or handle at the closed end of the igniter mechanically ignites the friction compound. This, in turn, fires the powder in the fuse.

b. *Weatherproof.* A weatherproof, time blasting, fuse igniter (fig. 8-14) consists of a barrel that holds the firing mechanism, and a coupling base that contains a percussion cap primer and has a pronged fuse retainer. Plastic sealing material is used to waterproof the joint of the time blasting fuse and fuse igniter. When the release pin is pulled, the firing pin strikes a percussion cap primer. This, in turn, ignites the fuse. This igniter will ignite the smooth surfaced fuse under any weather conditions, also under water.

8-8. Time Blasting Fuse

Time blasting fuse is used to transmit a flame from a match or igniter to a nonelectric blasting cap or other explosive charge. This fuse also provides a time delay during which personnel may retire from the danger zone. Time blasting fuse consists of two types: a corrugated, outer-surface type and a plastic-cover, outer-surface type (fig. 8-15 and 8-16). The latter type has single bands painted at 1-foot or 18-inch intervals and double yellow bands painted at 5-foot or 90-inch intervals, depending on the time of manufacture. Both fuses are similar, however, in use and functioning. The fuse is used in demolitions on land and underwater. When ignited by a match or a

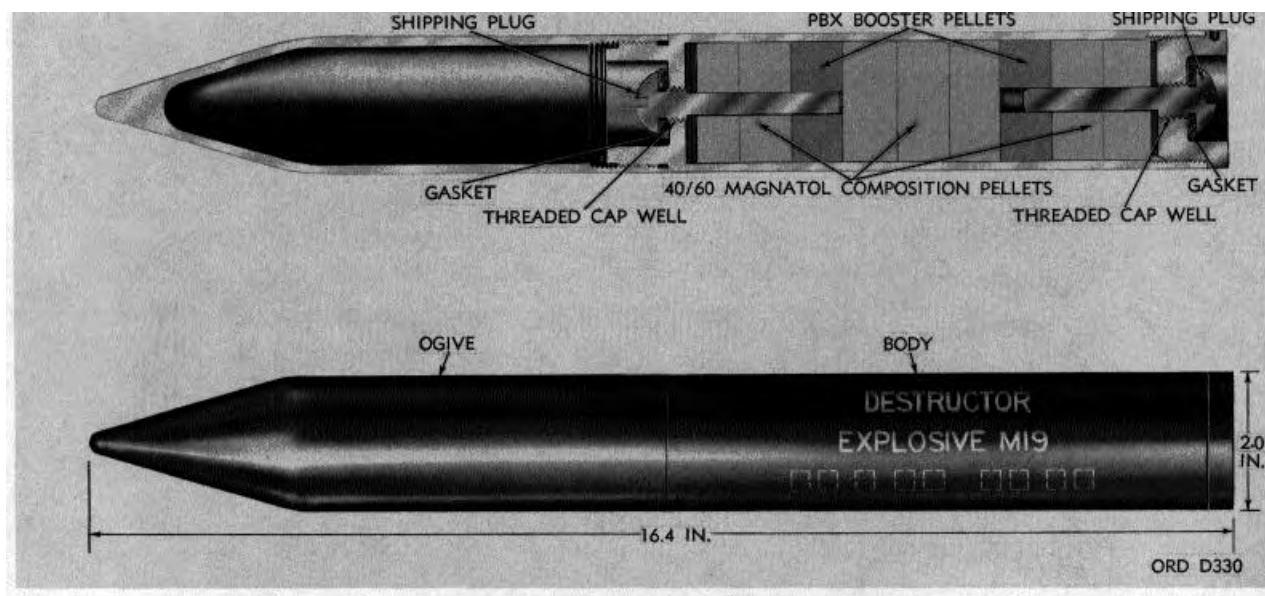

Figure 8-12. Explosive destructor.

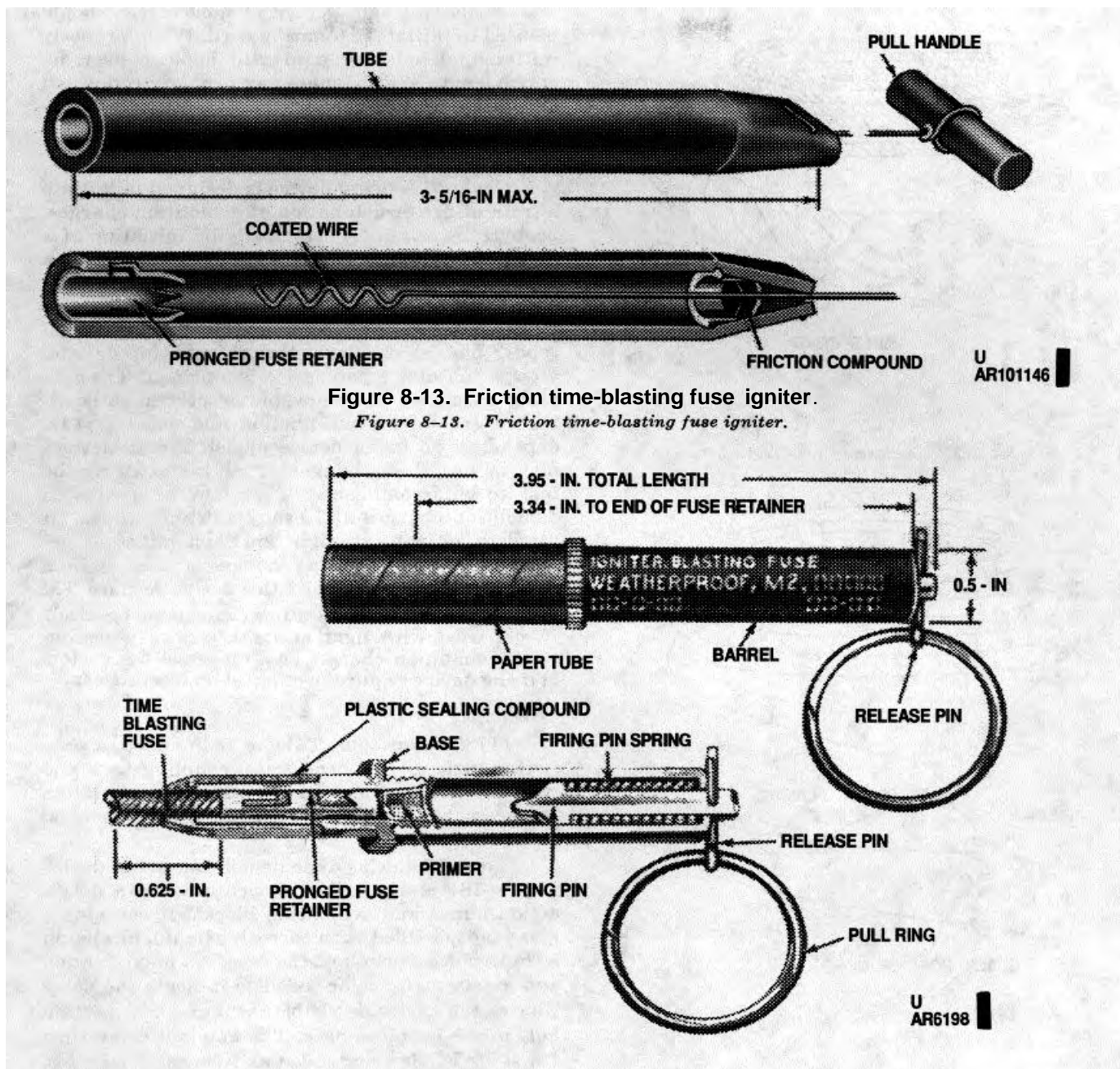

Figure 8-13. Friction time-blasting fuse igniter.

Figure 8-13. Friction time-blasting fuse igniter.

Figure 8-14. Weatherproof time-blasting fuse igniter

time-blasting fuse igniter, the black powder of the time blasting fuse transmits a flame to a nonelectric blasting cap that may be installed in a demolition charge. The 40 seconds per foot, however, will vary for the same or different roll under different atmospheric and/or climatic conditions, from a burning time of 30 seconds or less per foot to 45 seconds or more per foot. When used under water, the rate of burning is increased significantly. Therefore, each roll of fuse must be tested shortly before use.

8-9. Detonating Cord

Detonating cord (fig. 817) may be used as a deto-

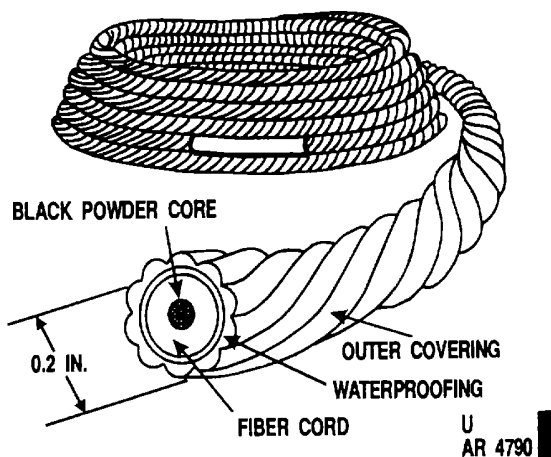

Figure 8-15. Time-blasting fuse (safety fuse)

Figure 8-15. Time-blasting fuse (safety fuse).

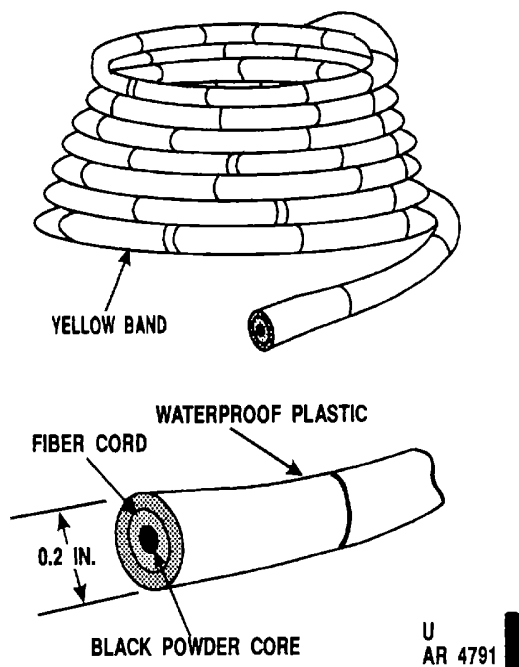

Figure 8-16. Time-blasting fuse.

nating agent, a primary agent, or alone as an explosive charge. It may be used for detonating single or multiple charges. It will transmit a detonating wave from one point to another at a rate of at least 5,900 meters per second. Detonating cord consists of a core of PETN in a textile tube coated with a layer of asphalt. The asphalt layer has an outer textile cover which is finished with a wax gum composition or plastic coating. See TM 9-1375-213-12 and TM 91375-213-34 for various detonating cords available. A blasting cap, electric or

nonelectric, should be used to initiate detonating cord. When properly initiated, detonating cord will explode over its entire length and detonate any properly connected demolition charge.

8-10. Firing Device and Components

a. *General.* A firing device is designed to initiate a train of fire or detonation of demolition charges, boobytraps or mines, principally by initiation of a nonelectric blasting cap or a mine activator. It is a separate item of issue and is packed in its own box. Firing devices are of two general types: tubular and box. The coupling base, fitted to all types, has a standard thread and nipple and always contains a percussion cap primer. The coupling base may be removable or permanently attached (as in the pull-friction and delay types), depending on firing device model. Firing devices may be used interchangeably, as indicated by the task to be accomplished. They may be used with demolition charges and heavy antitank mines (if fitted to activators), light antitank mines or destructors. When a firing device is used with a service activator or a practice activator (see TM 9-1345-203-12&P), a blasting cap cannot be used. When used with light antitank service mines or with demolition charges or a universal destructor, a firing device requires a crimped-on blasting cap.

b. *Types.*

(1) *Tubular type.* Tubular firing devices, consisting generally of head, case, coupling base and percussion cap primer, are arranged for actuation by pressure, pull, release of pull or chemical action.

(a) The delay-type demolition firing device (fig. 8-18) is a chemical device used with delayaction mines and demolition blocks. It contains a glass capsule filled with corrosive liquid, located in a thin-walled portion of the case. An identification and safety strip, color-coded to indicate the delay time of the device, is visible through an inspection hole in the coupling base. The nominal delay time (at +75°F.) is color-coded as follows: 9 minutes, black; 15 minutes, red; 1 hour, white; 2 1/2 hours, green; 5 1/2 hours, yellow; and 11 1/2 hours, blue. The nominal delay time is subject to temperature correction in accordance with a table furnished with the firing device.

(b) The pressure-type demolition firing device (fig. 8-19) is used in setting up boobytraps. On removal of the safety pin between the firing pin and primer, a pressure of about 20 pounds on

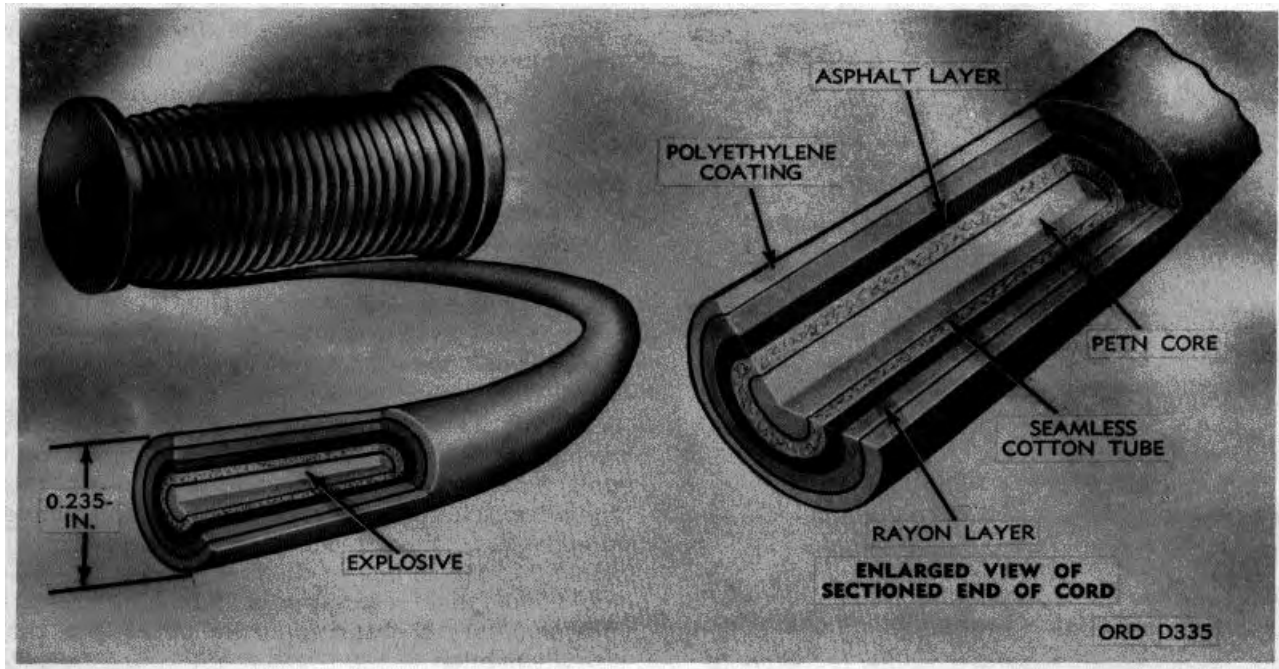

Figure 8-17. Typical detonation cord

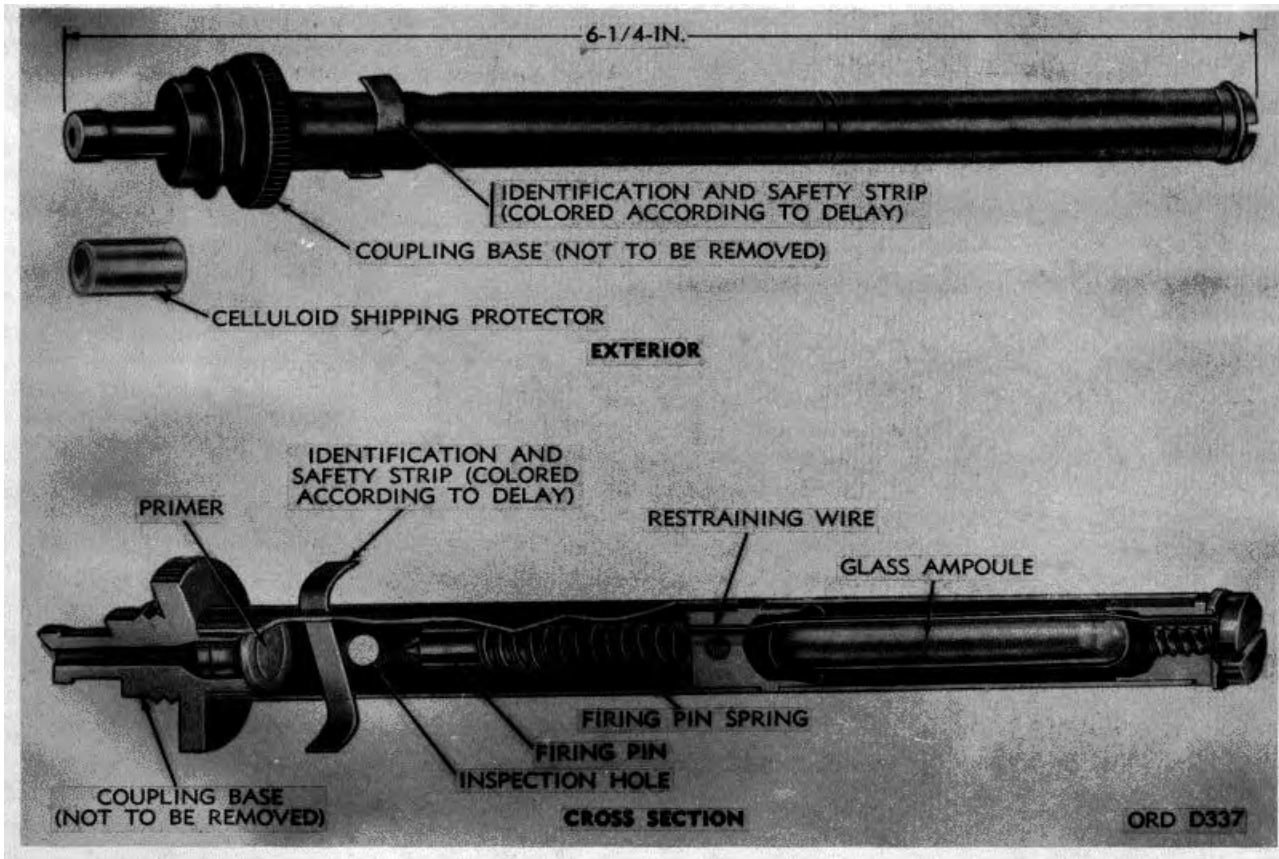
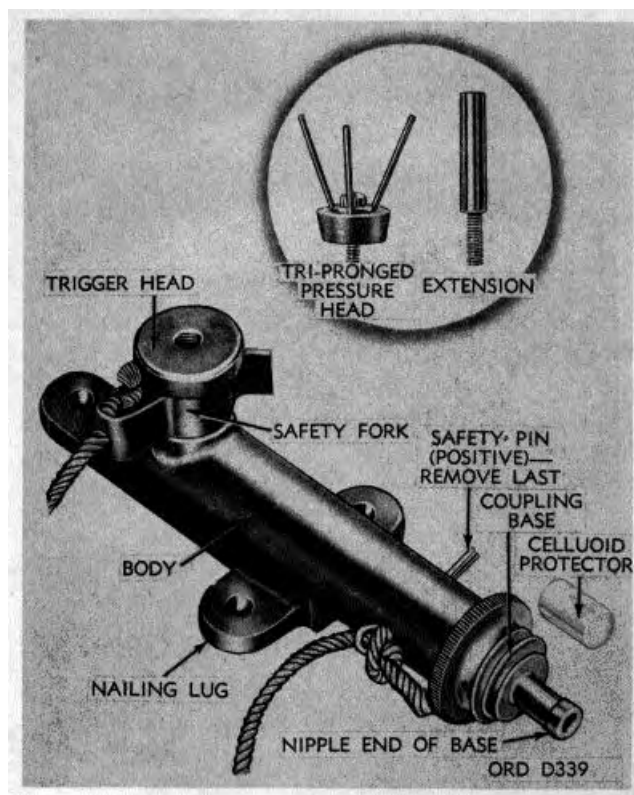

Figure 8-18. Delay-type demolition firing device



the pressure cap acts to release the spring-loaded firing pin that fires the primer.

(c) The pull-friction type, which contains a friction-initiated primer, is actuated by a pull wire. This type is used in setting up boobytraps. The body is plastic and the base is nonremovable. A coated wire, to which a spring and pull ring are attached, passes through the body, and through the friction compound into a nipple on the base. A direct pull of 3 to 11 pounds on the trip wire (pull wire) stretches the spring. This draws the coated wire through the friction compound. As a result, the friction compound ignites.

(d) The pull-release type (fig. 820) is a mechanical device actuated by either an increase (pull) or a decrease (release) of tension in a taut trip wire. This type is used with antipersonnel mines or in setting up boobytraps. Either a direct pull of 6 to 10 pounds on the trip wire or a release of tension (such as cutting or detaching the trip wire) releases the spring-loaded firing pin that fires the primer.

(e) The pull type is a mechanical device actuated by a pull on a trip wire (fig. 8-21). This type is used with some antipersonnel mines or for boobytrapping antitank mines. A direct pull of 3

Figure 8-19. Pressure-type demolition firing device

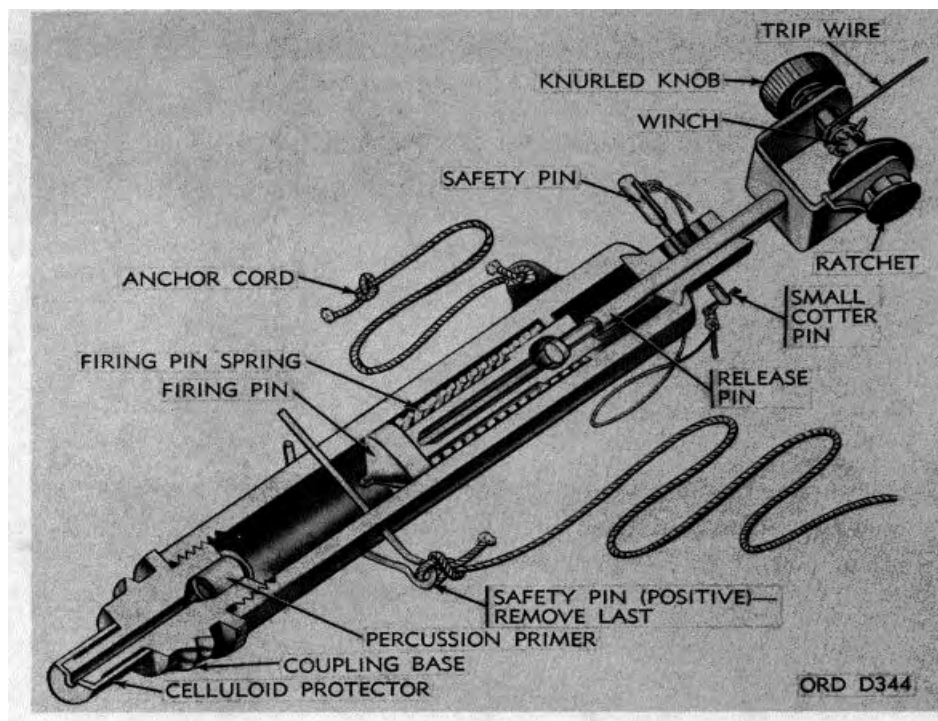

Figure 8-20. Pull-release type demolition firing device

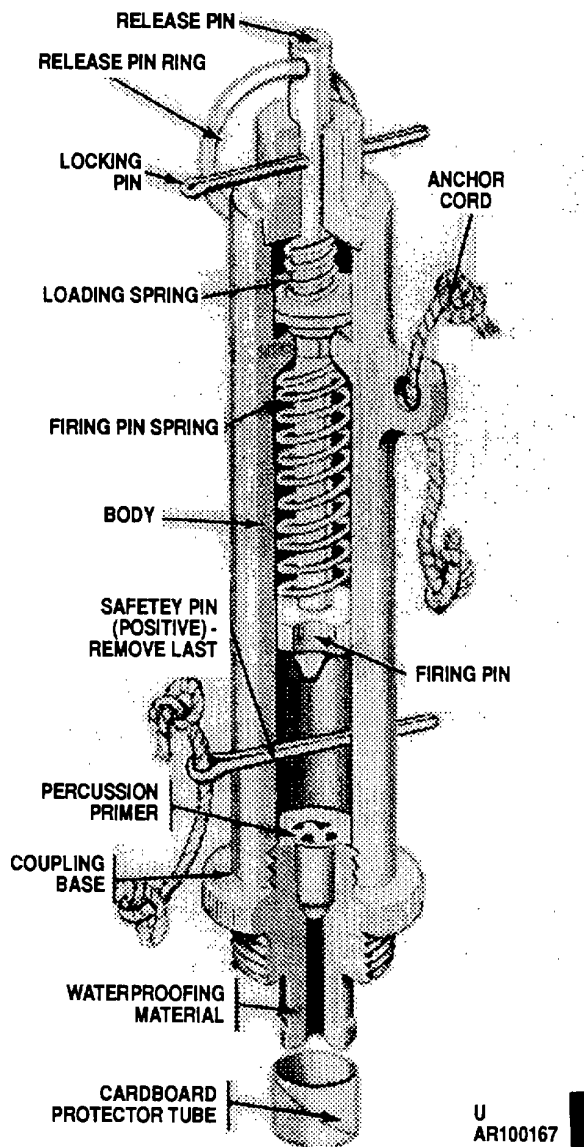

Figure 8-21. Pull-type demolition firing device

to 5 pounds on the trip wire releases the springloaded firing pin that fires the primer.

(2) *Box type.* Box-type firing devices, consisting of a rectangular steel body and primed coupling base, are actuated by release of pressure.

(a) The pressure-release-type firing device (fig. 822) is a mechanical device used to activate antitank mines equipped with supplementary fuze wells (cap wells). This type is also used for general boobytrap installations with charges having a threaded capwell. This device is activated by a spring-loaded firing pin, which fires the primer, when a restraining load of at least 5 pounds is removed from the release plate.

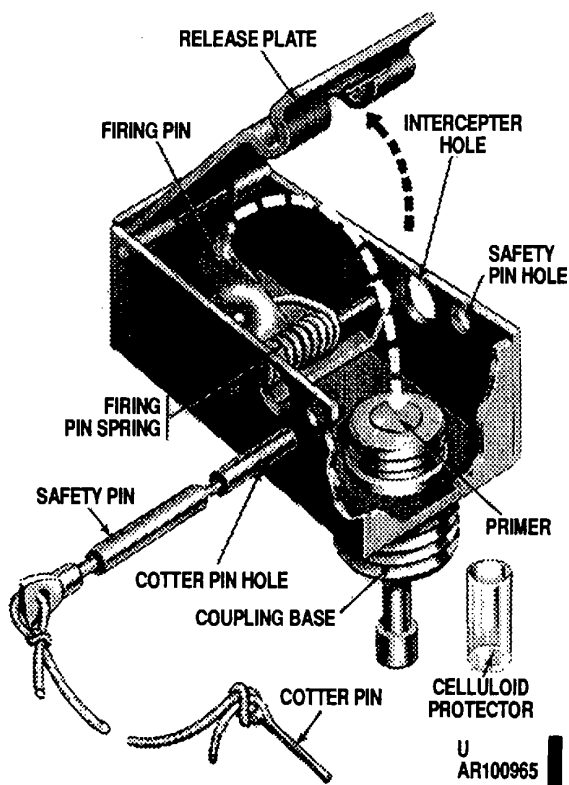
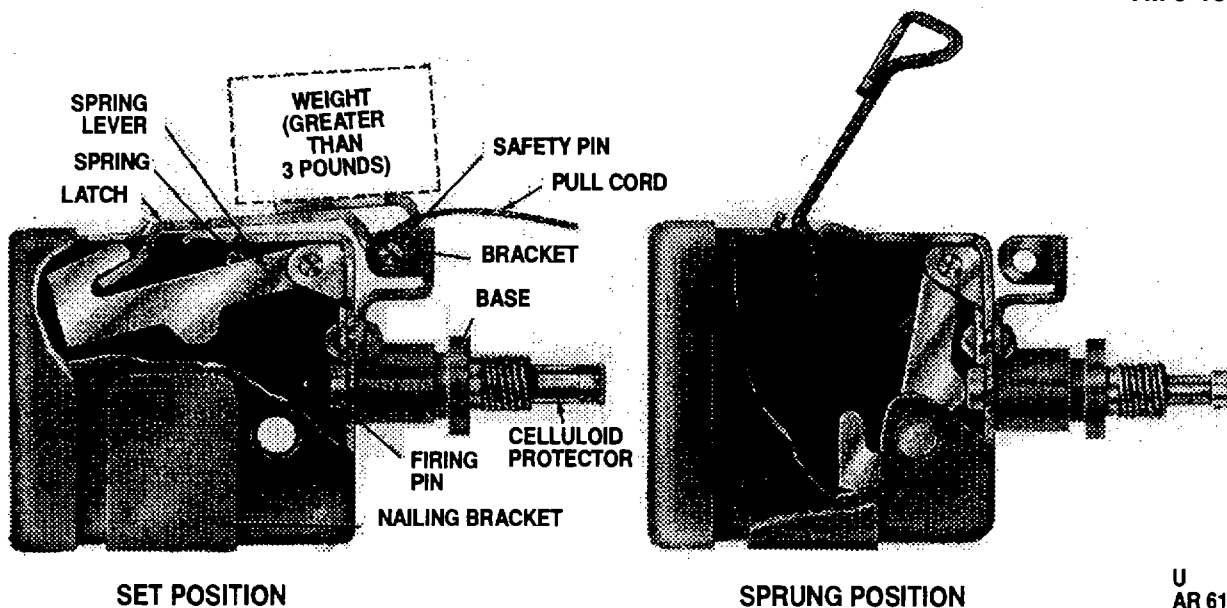

Figure 8-22. Pressure-release type demolition firing device

(b) The release-type firing device (fig. 8-23) is used in setting up boobytraps. A restraining weight of at least three pounds is applied on the top face of the latch at the time of installation. After the safety pin has been removed, displacement of the restraining weight releases the latch. This allows a spring lever to actuate the firing pin that strikes the primer.

(3) *Inert firing devices.* Inert firing devices used for training purposes are to be employed in exactly the same manner and with the same care and precautions as the explosive items they simulate. It is essential that personnel in training fully understand the procedures and instructions given in the manuals pertaining to explosives and firing devices, see TM 9-1375-213-12, TM 9-1375-213-34 and FM 5-250.

(4) *Percussion cap primers.* When struck by a firing pin, percussion cap primers (fig. 824) produce a small, intense flame to initiate a blasting cap or igniter charge. The primer body is a flanged copper or gilding-metal cup with a hole in the bottom. The body contains an inner inverted cup, an initiating charge and an anvil.



U
AR 6187

Figure 8-23. Release-Type demolition firing device

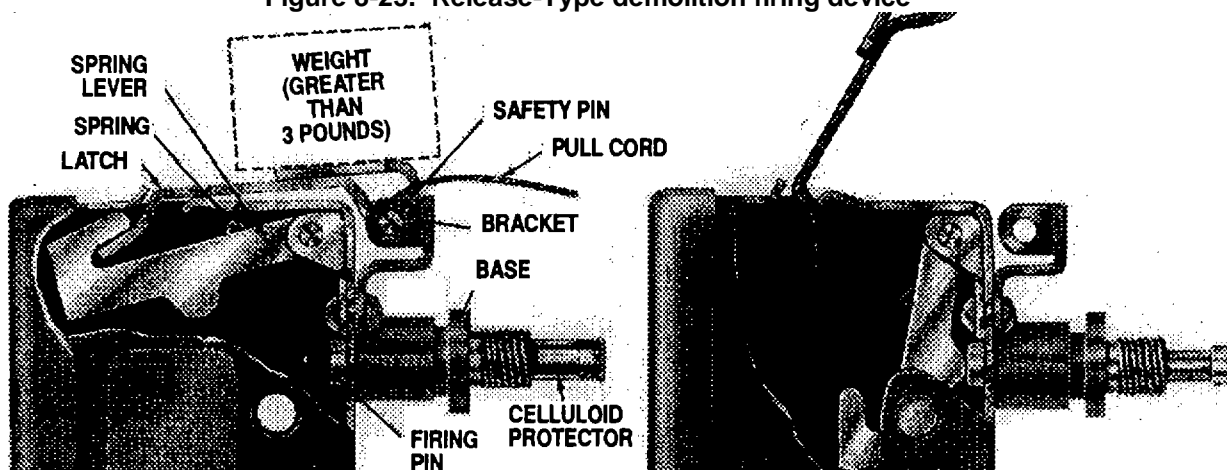

Figure 8-24. Percussion primer

Figure 8-25. Blasting caps

Firing devices are issued with this type of primer installed in the coupling base. The primer is also issued separately for repriming firing devices used with practice mines and boobytraps.

with a fuse igniter, or crimped to detonating cord. Special Army caps, electric and nonelectric, loaded with pentaerythrite (PETN), are used to detonate the less sensitive military explosives, such as TNT and ammonium nitrate. Commercial caps may be used to detonate the more sensitive explosives, such as dynamite, gelatin dynamite or nitrostarch. For detailed information on blasting caps, see FM 5-250, TM 9-1375-213-12 and TM 9-1375-213-34.

(5) Blasting caps. Commercial and Army blasting caps, electric and nonelectric, are used to initiate explosives (fig. 8-25). Army types consist of a thin, tubular, metallic shell about 2 1/2 inches long and 1/4-inch in diameter filled with small charges of sensitive high explosives. In priming, the caps are inserted directly into the cap wells of demolition explosives. The electric cap has wires for attachment to a blasting machine; the nonelectric cap may be crimped to any standard firing device. Nonelectric caps may also be crimped to safety fuse (time blasting fuse) fitted

c. *Miscellaneous Accessories and Tools.*

(1) *Priming adapter.* The explosive priming adapter (fig. 8-26) is a small, hollow, plastic, hexagonal-head cylinder that is threaded on one end.

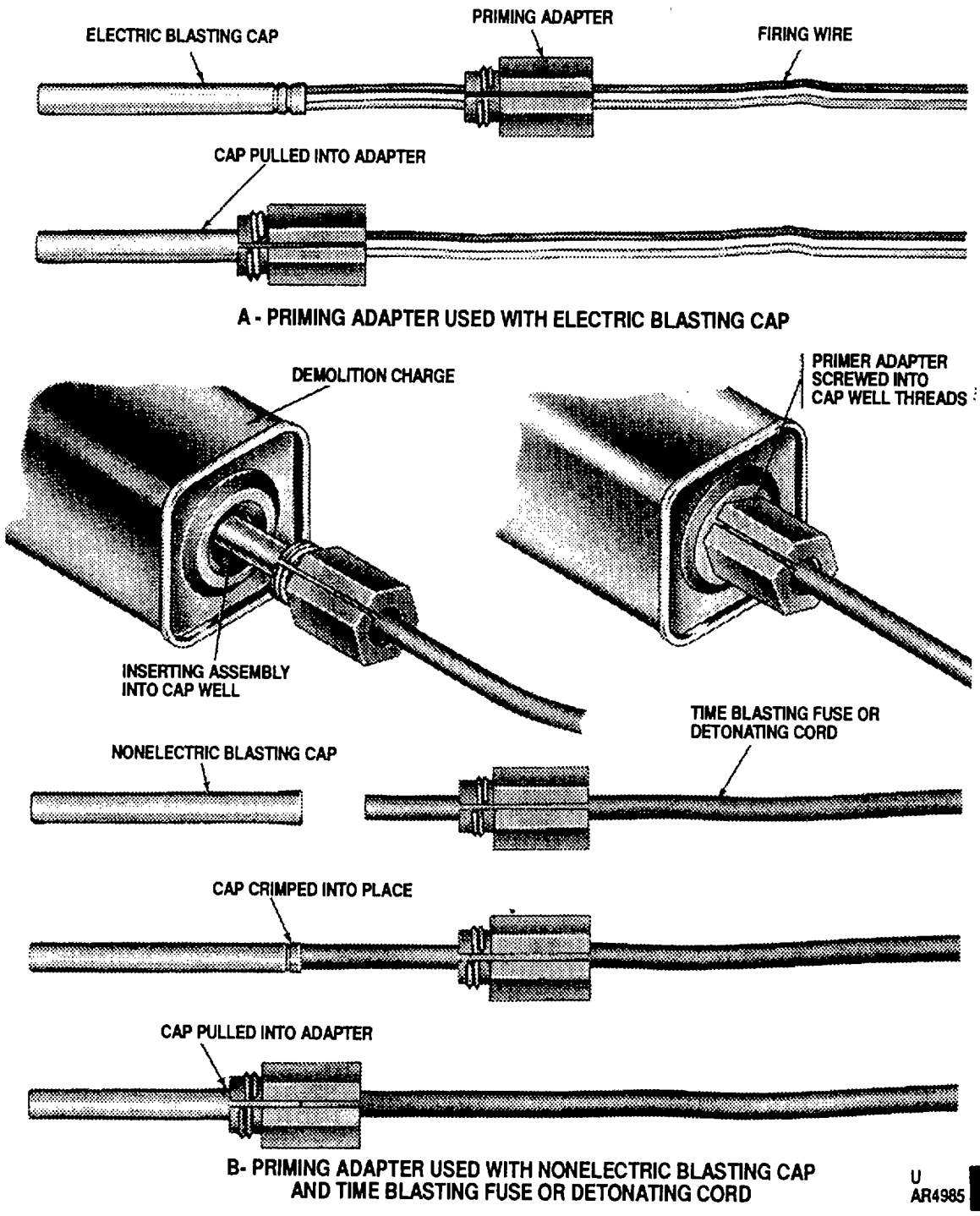

Figure 8-26. Use of explosive priming adapter.

The adapter simplifies priming of military explosives having threaded cap wells. The adapter may be used with an electric blasting cap, with a nonelectric blasting cap and safety fuse or with detonating cord.

(2) *Detonating cord clip.* The detonating cord clip is a small metal device used to join detonating cord.

(3) *Waterproof blasting cap sealing compound.* Waterproof blasting cap sealing compound

is used to moistureproof the connection between a nonelectric blasting cap and safety fuse. This compound is also used to moistureproof dynamite primers. The compound does not make a permanent waterproof seal. The newer compound is an RTV (room temperature vulcanizing) silicone rubber which seals better but takes longer to set up.

(4) *Electric wire and cable.* Single-conductor No. 20 AWG annunciator wire is issued for making connections between electric blasting caps or between cap and firing wire. The No. 18 AWG two-conductor cable is the standard firing wire and is carried on 500-foot firing wire reels.

(5) *Blasting galvanometer.* The blasting galvanometer is used to test electrical firing wire circuits. It contains an electromagnet, a small, special, silver chloride dry cell, and a scale with an indicator needle. This device is being replaced by the M51 blasting cap test set.

(6) *Blasting machines.* The blasting machines are small electric generators that produce current for firing electric blasting caps. There are three types in Army use: the 10-cap, twisting-handle type, the 30-, 50-, and 100-cap push-down-handle (rack bar), and the newer M32 (10 cap) and M34 (50 cap) squeeze-handle types. The capacity of a blasting machine is the number of electric blasting caps that it will fire if connected in series and operated correctly. Detailed information on blasting machines is contained in TM 9-1375-213-12, TM 9-1375-213-34 and FM 5250.

(7) *Cap crimper.* Cap crimpers are designed to squeeze the shell of the nonelectric cap tightly enough around the safety fuse or detonating cord to prevent separation. This crimp, however, does not interfere with burning of the powder train in the fuse. The standard cap crimper (with fuse cutter) has a narrow jaw that crimps a water-resistant groove.

8-11. Demolition Kits

a. *General.* Demolition kits contain explosive and nonexplosive items for performing various demolition tasks. Some kits are designed for general demolition; others, for specific demolition tasks. Kits include accessories, tools and other specialized components in specially designed containers.

b. *General Blasting Kits.* These kits are designated Demolition Kit, Blasting: Explosive Initiating, Electric and Nonelectric, and Demolition Kit, Blasting: Explosive Initiating, Nonelectric. They contain explosives and equipment needed for most general demolition work. Components of these kits are listed in TM 9-1375-213-12 and TM 9-1375-213-34.

c. *Bangalore Torpedo Demolition Kit.* The bangalore torpedo demolition kit (fig. 8-27), composed

of single, high-explosive-filled steel tubes or multiple lengths with connecting sleeves, is used for blasting a path through wire entanglements or other obstructions. The individual tubes, called loading assemblies, may be used as explosive charges for other demolition purposes. The bangalore torpedo kit consists of 10 loading assemblies, 10 connecting sleeves, and 1 nose sleeve. The loading assembly is a 5-foot-long, steel tube filled with explosives. The M1A1 torpedoes have a main filler of approximately 9 pounds amatol with a TNT booster surrounding the cap wells at each end. The M1A2 torpedoes have a main filler of approximately 10 pounds Comp B with a Comp A3 booster at each end. Each end of the tube contains a threaded cap well. This well accommodates a blasting cap which may be fitted to any standard firing device or other means of initiation. A few turns of detonating cord wrapped around the M1A1 loading assembly will also initiate it when detonated. The M1A2's booster is less sensitive and cannot reliably be initiated by detonating cord. The connecting sleeve is a short tube which accommodates 2 loading assemblies that can be held by 3 spring clips. The nose sleeve, which is held in place by a spring clip, has a rounded point for ease in pushing the torpedo through obstacles.

d. *Earth Rod Explosive Kit.* The earth rod kit is used for making holes in earth or soft shale, not in rock or other hard material. Holes may be as deep as 6 feet and several inches in diameter. The assembled hole-making unit of the earth rod kit (fig. 8-28) consists of a 6-foot steel rod, a detachable point that fits the lower end of the rod, and a cylindrical firing chamber that screws on at the upper end. A propelling charge placed in the firing chamber, when exploded by a primer attached to a piece of time blasting fuse and a fuse igniter, drives the rod into the earth. A tripod with adjustable legs is used to hold the rod steady for firing. A removable handle, an extractor that grips and lifts the rod, and an extension that can be used to lengthen the rod are used to pull the rod from the earth. A forked, inserting rod is furnished for inserting a small linear charge (or an improvised linear charge made of detonating cord) into the hole made by the rod.

e. *Demolition Charge Assembly.* The demolition charge assembly (fig. 8-29) consists of 8 block demolition charges, 8 block demolition charge hook assemblies, and 2 demolition priming assemblies. The priming assembly (fig. 8-30) consists of a length (approximately 5 feet) of detonating cord, 2 hexagonal-shaped, plastic adapters, each holding a booster, and 2 detonating cord clips. The adapters attached to the cord, one at each end, are threaded to fit the cap well of demolition blocks or light antitank mines. Each booster contains a charge of 13.5 grains of RDX. The clips, on the

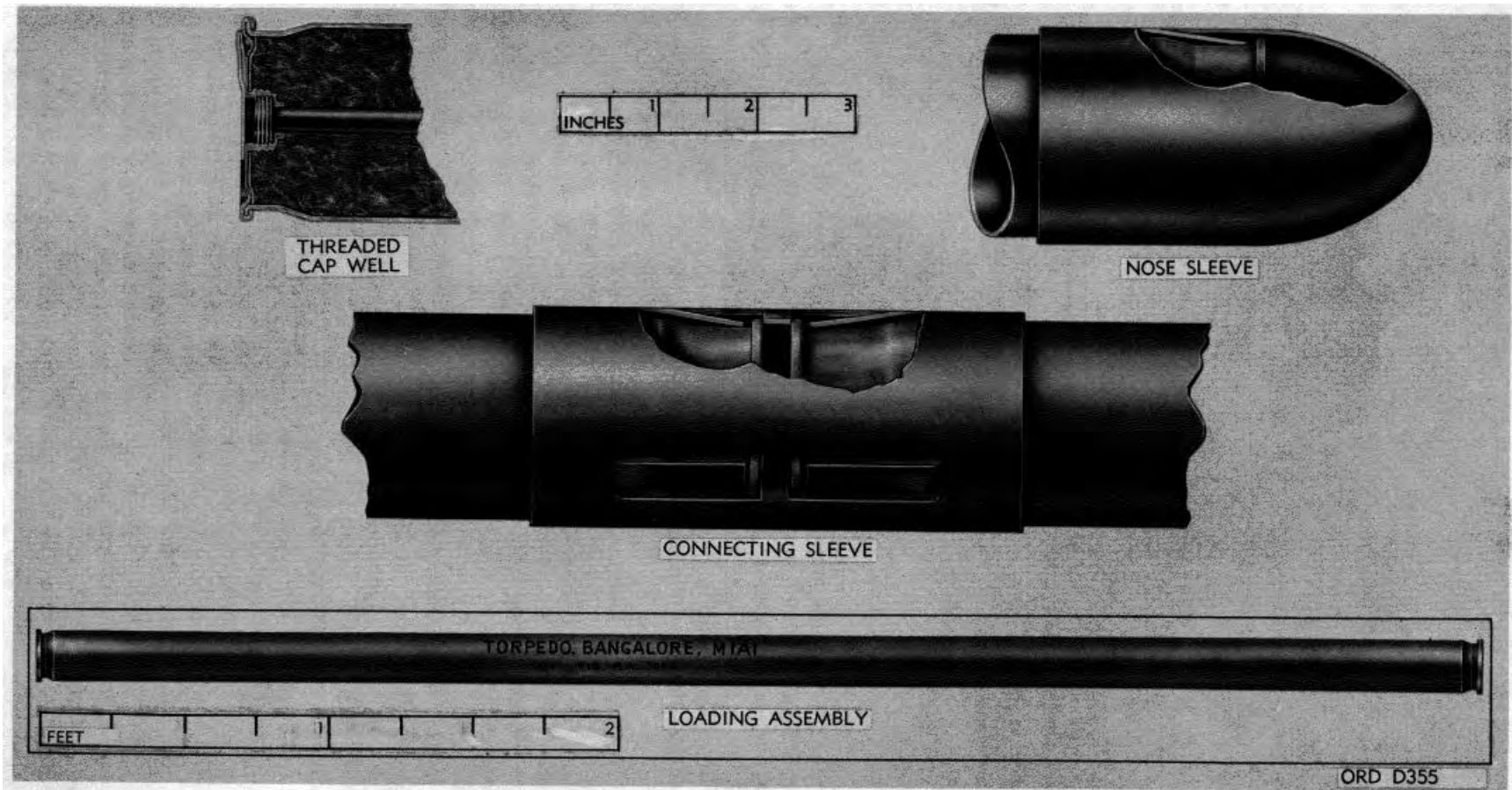

Figure 8-27. Bangalore torpedo demolition kit

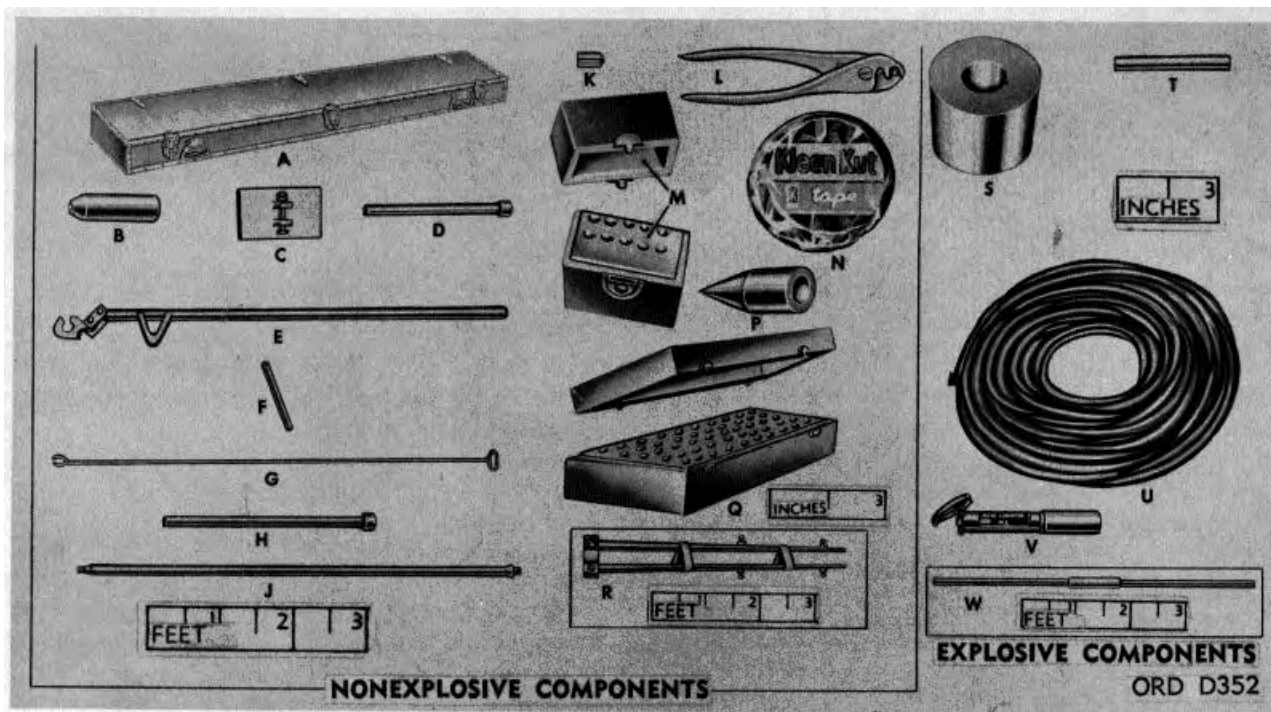

Figure 8-28. Earth rod explosive kit

cord about 20 inches from either end of the assembly, are for making junctions on main lines of detonating cord in a demolition system. The demolition charge assembly, main lines and their initiators are used to form a demolition system with one or more demolition blocks as the main explosive charge.

f. Mine-Clearing Devices.

(1) *Projected charge demolition kit (antipersonnel mine clearing).* This kit (fig. 8-31 and 8-32) is a flexible linear charge used to clear narrow lanes in antipersonnel mine fields. The nylon-covered detonating cable (fig. 8-31) is 170 feet long, about 1 inch in diameter, weighs 63 pounds and contains 46 pounds of oil-soaked PETN. This charge consists of 19 strands of special detonating cord, each strand containing approximately 100 grains of PETN per foot. Regular detonating cord should not be used as a substitute. One end of the cable has a cable grip with loops for anchoring the cable to a stake driven in the ground. This end contains a booster charge and a threaded cap well for inserting a 15-second delay detonator for exploding the cable. In the carrying case, the cable is coiled around a cone, which is removed before the unit is fired. The cable is projected across the minefield by a rocket motor (fig. 8-32) and then drops onto the field. The cable is then exploded by the detonator in the anchored end. A launcher, which is a

folding stand of aluminum angles, is used to hold the rocket motor in position for firing. The cable is issued either with or without the rocket motor. In the latter case, the rocket motor is requisitioned separately. One fuse igniter is provided for igniting the rocket motor. The entire assembly is contained in a carrying case, which is a cylindrical aluminum can with removable lids, provided with carrying handles on both ends. The loaded case weighs 92 pounds.

(2) *Projected charge demolition kit (antitank mine clearing).* These kits (fig. 8-33) are used principally to breach minefields. They may also be used to breach bands of log posts, steel rails, antitank ditches and some small concrete obstacles. Some demolition kits consist of sections of two parallel linear explosive charges encased between corrugated metal plates or tubes. These are bolted together to form a rigid assembly that can be towed or pushed by a light or medium tank. The charge is exploded by action of a bullet impact fuze actuated by fire from a machinegun on the tank. Another type (fig. 8-34 and 8-35) consists essentially of a waterproof skid, a rocket motor, and a linear demolition charge. It is towed to the edge of a mine field. The towing vehicle is then moved out of the danger zone by its operator, who electrically initiates a thruster on the kit to remove the main cover. Automatic elevation of a

rocket launcher tube occurs as the cover slides from the kit. The operator then electrically ignites the rocket motor which carries the linear charge across the minefield. When the linear charge stops moving, the operator initiates the fuze. This causes the charge to explode.

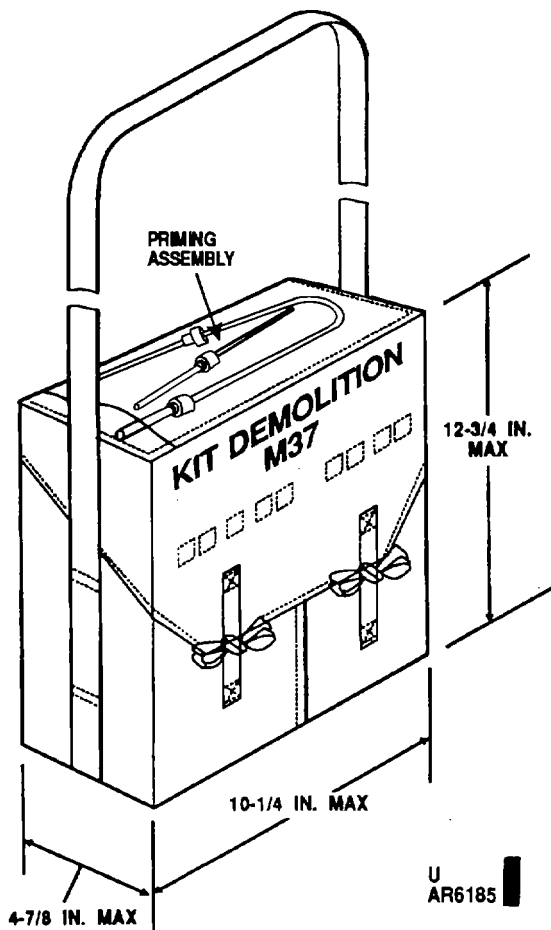

Figure 8-29. Demolition charge assembly M37

8-12. Care and Precautions in Handling

See TM 9-1300-206, TM 9-1375-213-12, TM 91375-213-34, TM 750-244-5-1, FM 5-250 and AR 385-63 for detailed information concerning appropriate safety precautions to be observed in handling demolition material. Also, observe the following:

- a. Handle demolition charges in accordance with sensitivity of explosive comprising charge.
- b. Do not expose demolition blocks of plastic explosive to open flame. They ignite easily and burn with intense heat. Burned in large quantities, they may explode.
- c. Handle dynamite with extreme care. Dynamite is more sensitive than other explosives. It may be exploded by flame, sparks, friction, and sharp blows, including impact from bullets or shell fragments.

8-13. Packing and Marking

a. Packing.

(1) *Explosive charges.* Block demolition charges are packed in haversacks or plastic bags within wooden boxes. TNT explosives are packed in wooden boxes. The ammonium nitrate cratering charge is packed one per wooden box. From 1 to 8 shaped charges are packed in wooden boxes, depending on weight of the charge. Dynamite is usually packed 50 pounds per commercial wooden box. High-explosive destructors are packed 1 per fiber container and 50 containers per wooden box. Some newer items are packed in wirebound wooden boxes.

(2) *Priming and initiating components, accessories and tools.* Concussion detonators are packed in individual metal containers, 50 containers per wooden box. Delay detonators are packed 10 per package, 5 packages per inner package, 4 packages (200 detonators) per wooden box. Weatherproof fuse igniters are packed 5 per waterproof carton, 60 cartons per wooden box.

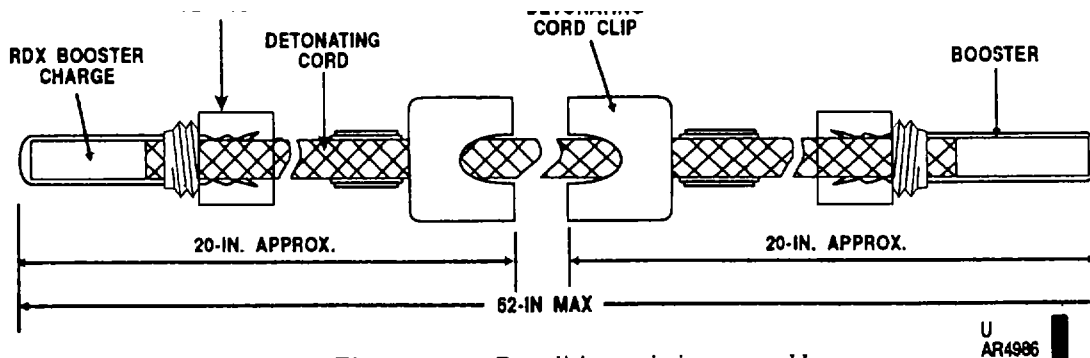
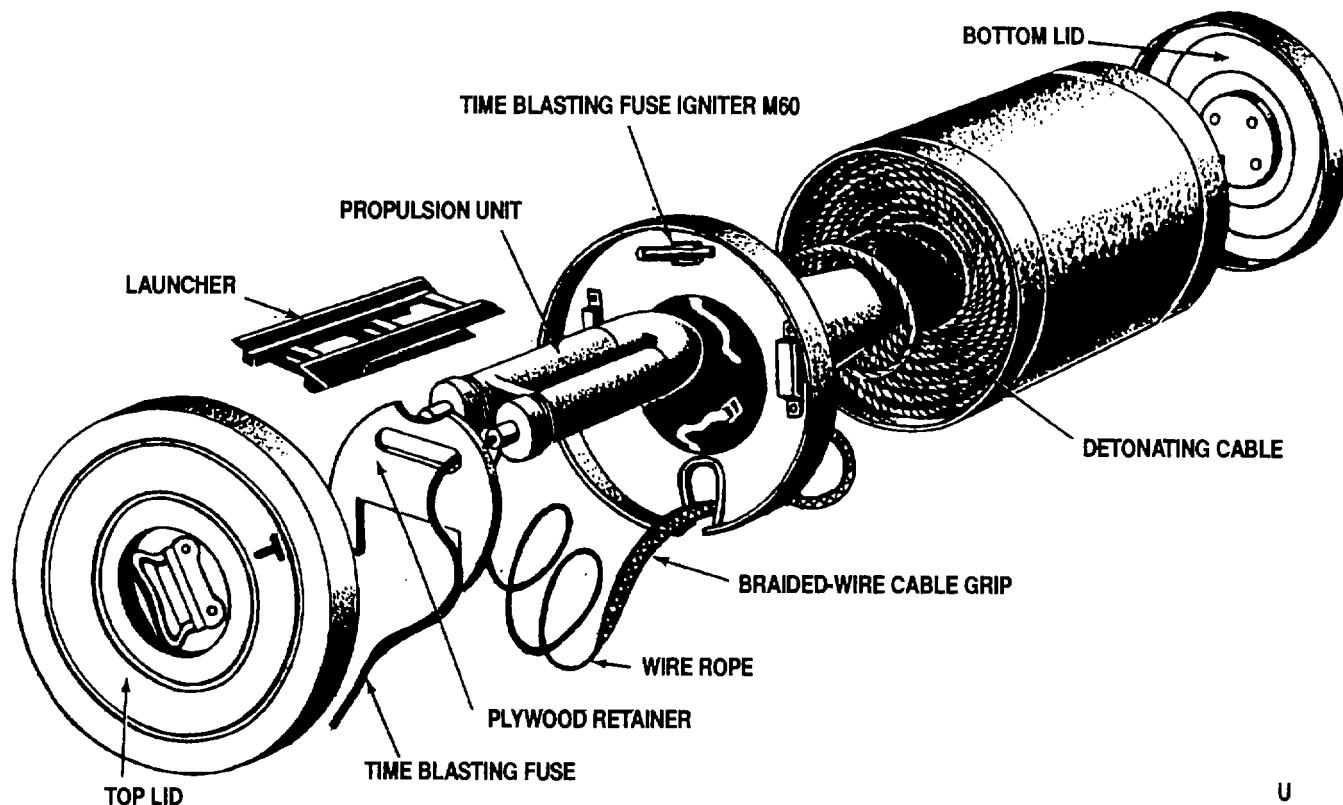

Figure 8-30. Demolition priming assembly.

Figure 8-30. Demolition priming assembly



U
AR4987

Figure 8-31. Projected charge demolition kit—arrangements of components in case .

Time blasting fuse is packed in 50-foot coils, 2 coils per package, 5 packages per sealed metal can, 8 cans (4,000 feet of fuse) per wooden box. The 2-coil packages are also packed either 30 or 60 per wooden box. Detonating cord is issued in spools of 50, 100, 500, or 1,000 feet. The 50-foot spools are packed 100 per wooden box; 100-foot spools, 50 per wooden box; 500 and 1,000-foot spools, 8 per wooden box. Firing

devices are packed 5 or 10 devices per inner box. Trip wires are packed with pull-type firing devices. Inner boxes are packed in wooden boxes that contain from 120 to 250 devices. Primers are packed 2,500 to 10,000 per wooden box. Blasting caps are packed 350 to 500 per wooden box or as required. Most accessories and tools are packed as required.

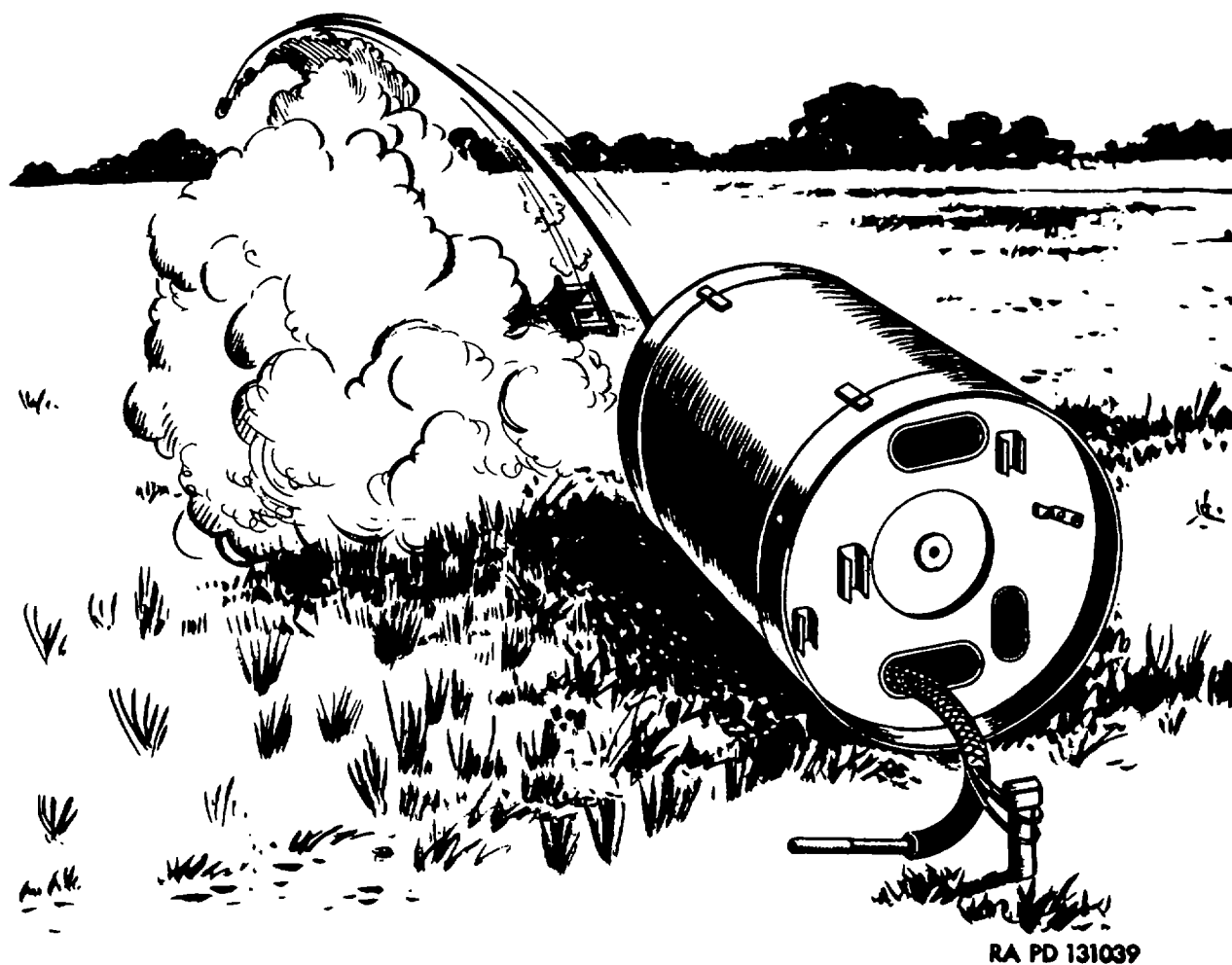

Figure 8-32. Projected charge demolition kits-laying cable over antipersonnel mine fields

(3) *Demolition kits.* Explosive items of blasting demolition kits are packed, shipped and stored separately from nonexplosive items. Standard packing is used for explosive components. Nonexplosive components are issued initially in a chest, but may be requisitioned separately as replacement items. Earth rod kits are packed in plywood boxes. Demolition charge assemblies are packed in haversack-type carrying cases, with priming assemblies attached to the top of each case. Bangalore torpedo kits are packed in wooden boxes. Demolition training kits are packed in the standard platoon demolition chest.

(4) *Mine-clearing devices.* Antipersonnel, mine-clearing detonating cable, including accessories, is contained in a waterproof aluminum carrying case, overpacked in a wooden box. Antitank, mine-clearing devices are packed in large wooden crates.

b. Marking. In addition to nomenclature and ammunition lot number, packages prepared for shipment are marked with the Department of Transportation (DOT) shipping name or classification of the article, volume and weight.

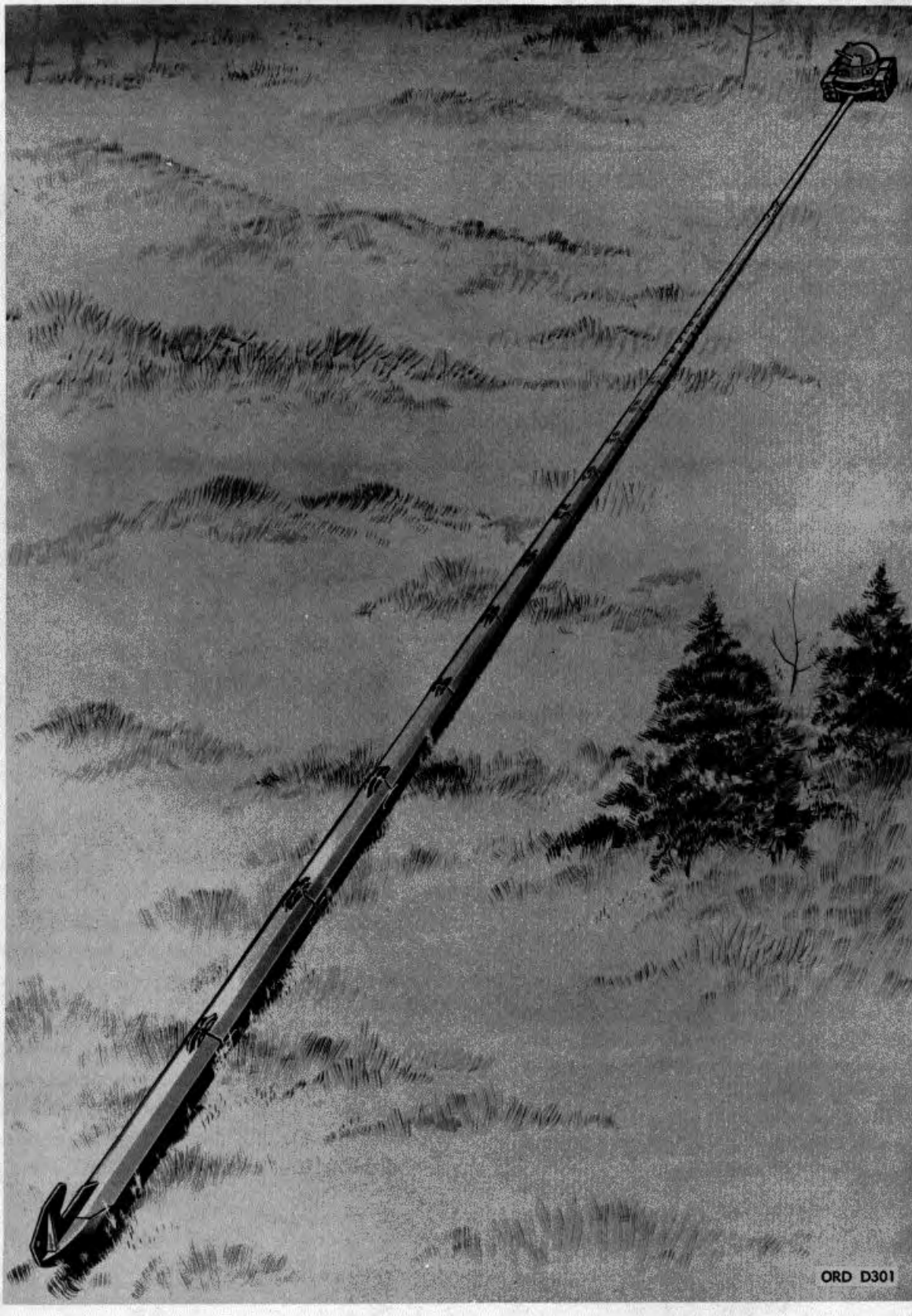

Figure 8-33. Typical projected charge (rigid type) being pushed by a medium tank

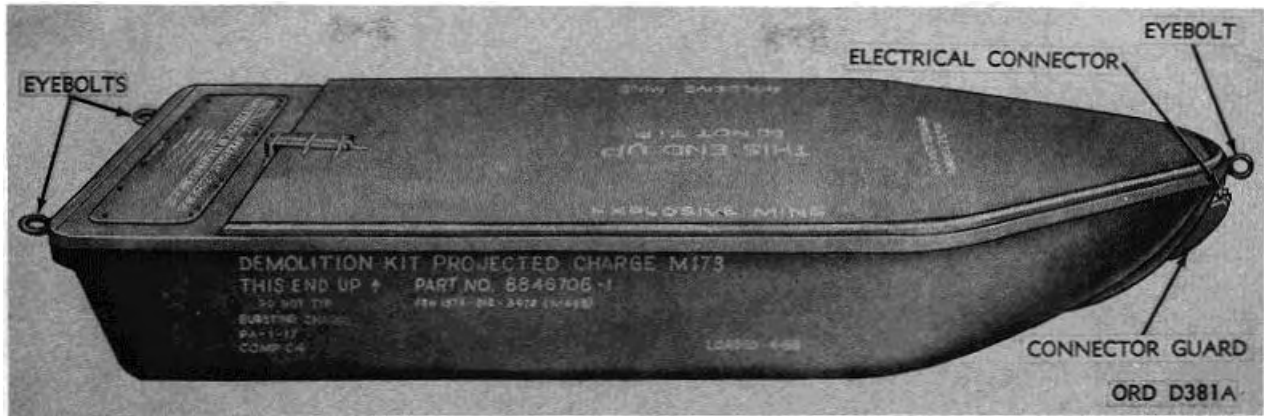

Figure 8-34. Linear projected charge.

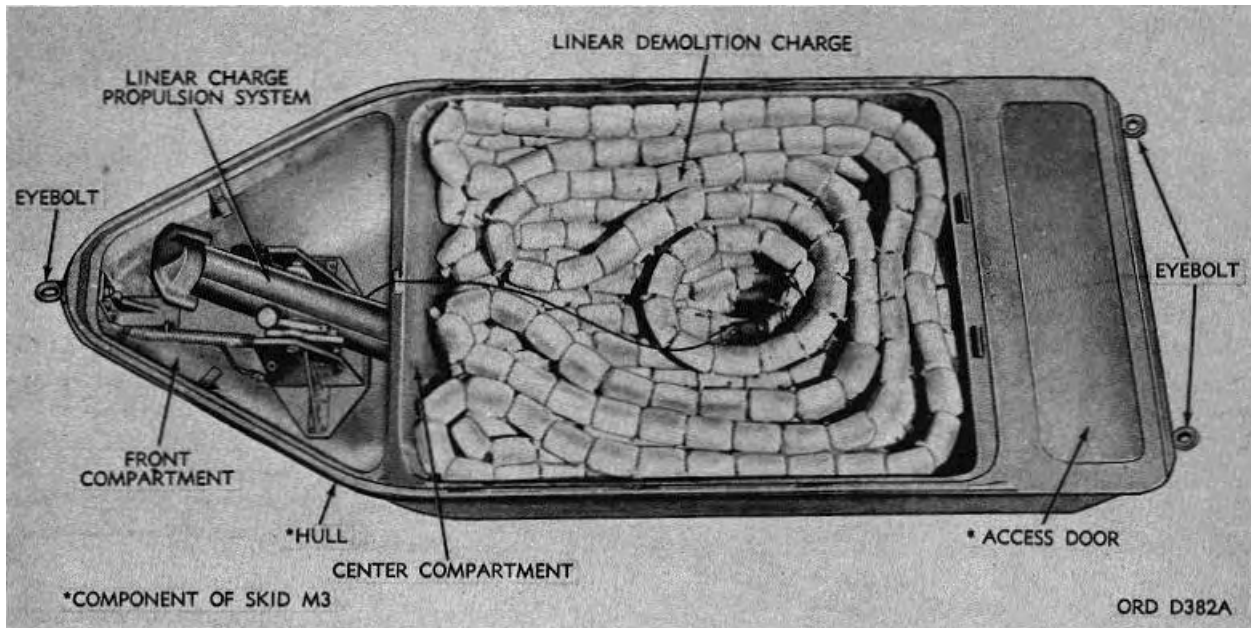

Figure 8-35. Linear projected charge (cover removed).

CHAPTER 9

PYROTECHNICS

9-1. General

Military pyrotechnics (fig. 9-1) are used for illumination, signaling, and simulation of battle noises and effects. Artillery projectiles and hand grenades used for illumination and signaling are described in chapters 4 and 6, respectively. Photoflash and target-identification bombs are described in chapter 10. Other pyrotechnic items are described below and in TM 9-1370-203-20&P

a. Complete Round. Pyrotechnics are usually issued in the form of complete rounds, each consisting of all the elements necessary for firing once. Components of large aircraft pyrotechnics (photoflash and target-identification bombs, etc.) are issued separately and assembled in the field.

b. Ignition Train. Pyrotechnics generally function by means of an ignition train (fig. 9-2), similar to the explosive train of other ammunition. The train is initiated by means of a percussion, friction or electric primer. The flame produced on initiation is transmitted successively to a propelling charge, delay element, expelling charge, and pyrotechnic composition. One or more of the intermediate elements between initiator and pyrotechnic composition may be omitted, depending upon the requirements of the item.

c. Pyrotechnic Compositions.

(1) In general, pyrotechnic compositions consist of various combinations of the following elements:

(a) Oxidizers, such as chlorates, perchlorates, peroxides, chromates, and nitrates that provide some oxygen for burning. Pyrotechnic compositions may not always contain sufficient oxygen for burning and, in such cases, must use oxygen from the air.

(b) Fuels, such as aluminum and magnesium powder, sulfur, lactose, and other easily oxidizable materials.

(c) Binders and waterproofing agents, such as asphalt, shellac, linseed oil, resins, resinates and paraffin, are still being used in limited quantities. They are gradually being replaced, however, by newer polymeric materials, such as epoxy and polyester resins and synthetic rubber.

(d) Organic dyes or inorganic salts are used to produce colored smokes.

(e) Color intensifiers, such as polyvinyl chloride, hexachlorbenzene, and other organic chlorides. In some cases, a single material may perform more than one of the functions in (a) through (d), above.

(2) Pyrotechnic smoke compositions are of two general types:

(a) Those that burn with practically no flame but with the formation of a dense colored smoke as a product of combustion.

(b) Those that burn at a temperature so low that an organic dye ((1)(d), above) in the composition will only volatilize and color the smoke, rather than burn.

d. Identification. As indicated in chapter 1, pyrotechnic items are identified by markings (in black) on the item and by bands or patches in the color of the signal produced. The top of a launcher-type ground signal is painted the color of the signal and is also marked with two embossed letters for identification in the dark. Overage flares and those of substitute composition, assigned to training, have a 2-inch blue band stenciled around the body; they may also be stenciled FOR TRAINING USE ONLY. Certain aircraft flares have the word FRONT stenciled on the front of the case. Location of suspension bands is indicated by black bands painted on the case. Guide flares have a patch on the closing cover indicating the color of the flare. Embossed points at the center of the patch permit identification in the dark. One, two or three embossed points identify white, red and green flares, respectively.

e. Projection.

(1) Mechanical equipment, mounted in an aircraft, or a pyrotechnic pistol is usually required to launch or project aircraft pyrotechnics.

(2) Signals that are fired from the ground are either hand-held or projected from the following:

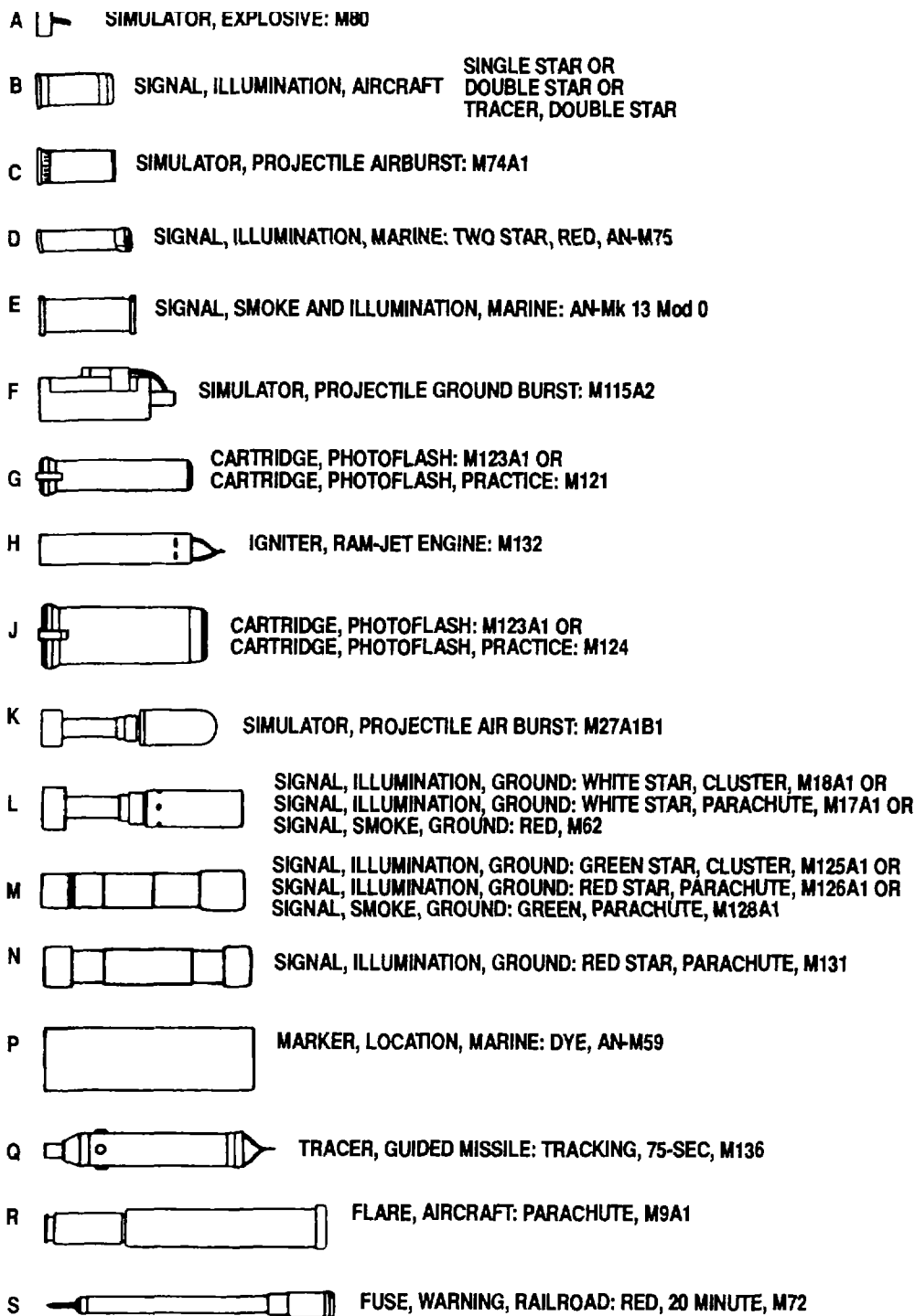

U
AR4994

Figure 9-1. Types and comparative sizes of military pyrotechnics.

- (a) Pyrotechnic projectors or pistols.
- (b) Small arms rifles equipped with grenade launchers and special blank cartridges.
- (c) Hand-held expendable launchers that form part of the signal assembly for rocket-assisted signals.
- (d) Manually operated (lanyard-type)

ground signal projectors mounted on staff-like supports that are anchored to the ground by spikes.

(3) The white smoke puff charge is fired from a smoke-puff discharger; powder from the charge, which is ignited by a smoke-puff percussion cap, serves as the propellant.

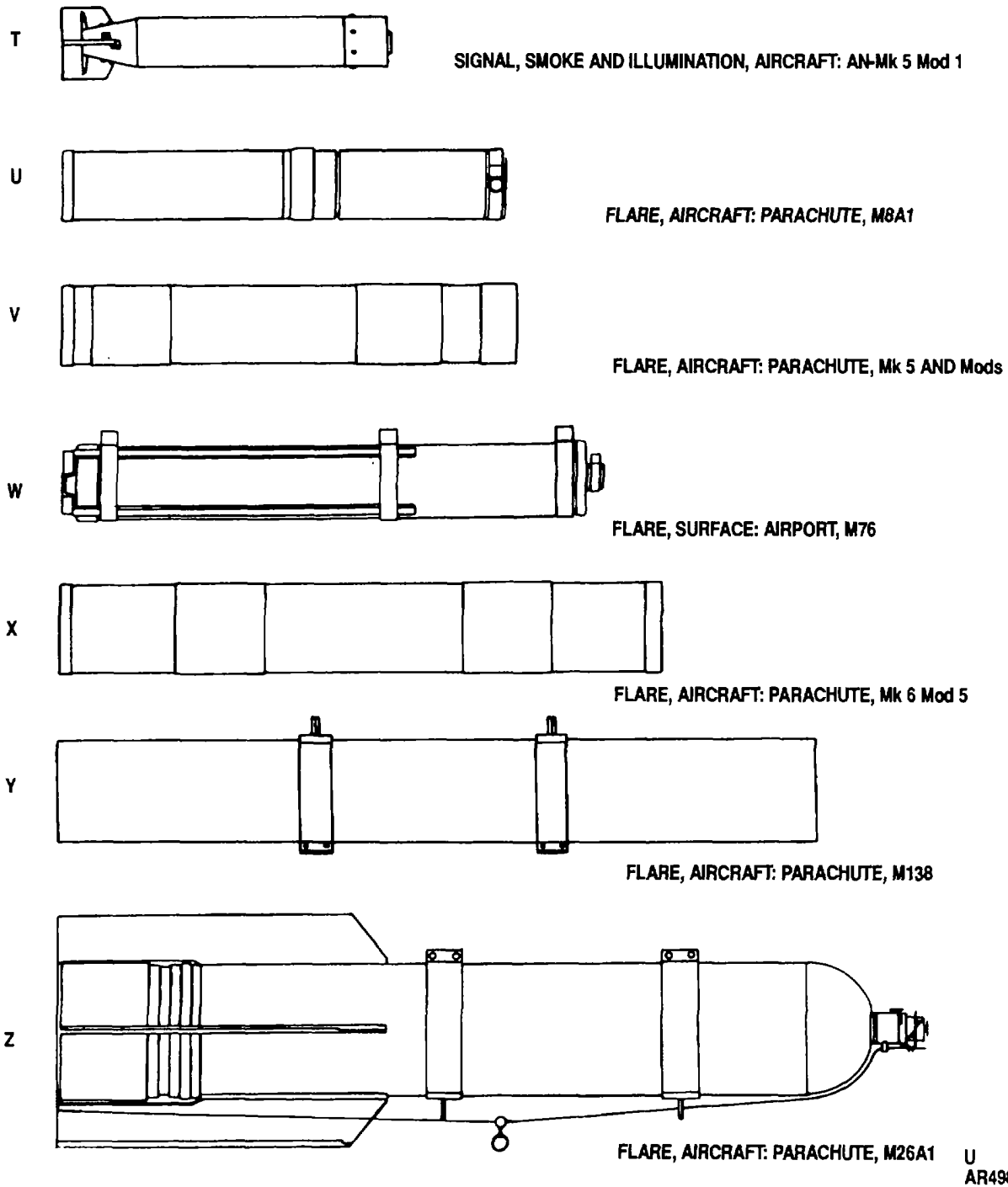

Figure 9-1.--Continued.

(4) The gunflash simulator is fired from a steel firing tube embedded in earth or sand bags. Some simulators burn in place; others are thrown by hand.

9-2. Classification

Pyrotechnics are classified according to purpose as

illuminants, signals and simulators; according to use, as aircraft and ground.

9-3. Visibility

a. The principal factors controlling visibility of pyrotechnics are design, position, and natural conditions of light and atmosphere.

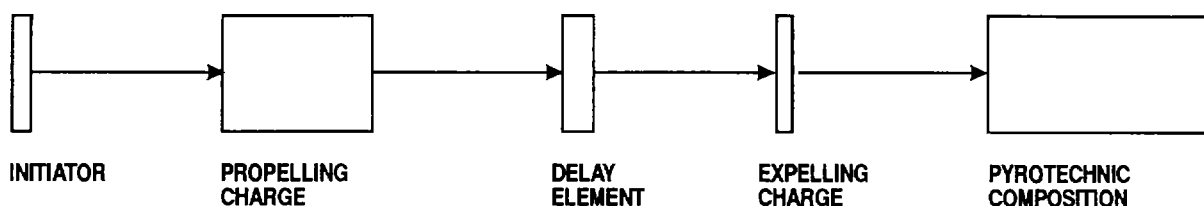

U
AR4989

Figure 9-2. Representative ignition train.

(1) Factors of design include luminous intensity (candlepower); color (hue and degree of color saturation); and degree of separation of a composite signal.

(2) Factors of position include height at which the flare or signal functions; distance of observer from signal; distance of flare from object to be illuminated; background; and relative position of flare, object and observer.

(3) Natural conditions of light and atmosphere are influenced by degree of natural illumination; color and brightness of the sky; and clarity of the atmosphere as affected by presence of haze, fog, dust, smoke, rain or snow.

b. A table of pyrotechnical data pertaining to specific items is published in TM 9-1370-203-20&P Tables of factors, including candlepower of specific items and optimum height, area illuminated, and distance for pyrotechnics suitable for battlefield illumination, are published in pertinent field manuals. Table 9-1 shows candlepower of various types.

Table 9-1. Pyrotechnic Types and Candlepower.

Type	Candlepower
Trip flare or tow target.....	50,000
Illuminating projectile	300,000 to 1,000,000
Airport flare, fusees	60,000
Aircraft parachute	60,000-750,000- 900,000
Reconnaissance and landing.....	800,000
Photoflash cartridge	120,000,000 peak- duration 0.30 second
Photoflash bomb.....	80,000,000 candle second for optimum 0.040 second*
Signals-white	50,000 for 20 to 30 seconds
green	5,000 for 20 to 30 seconds
amber	4,000 for 20 to 30 seconds
red	20,000 for 20 to 30 seconds

* 3,000,000,000 to 4,000,000,000 candlepower at peak.

9-4. Types

a. General. Pyrotechnics (fig. 9-1) consist of flares, signals, photoflash cartridges and items designed for various kinds of training.

b. Purpose. Flares are designed to provide a strong light (e.g., to illuminate terrain for various air and ground tactical operations) for an appreciable period. Types include aircraft flares (projected from aircraft), ground flares used on, or projected from, the ground), guide flares and ignition flares. Signals are designed for both aircraft and ground use for various types of signaling in tactical and protective operations. Photoflash cartridges are designed for use in connection with aerial photography during reconnaissance missions. Pyrotechnic training items are used as targets for antiaircraft gunnery practice and to simulate combat conditions for troop training.

9-5. Aircraft Flares

a. Aircraft flares provide illumination for target marking, battlefield visibility, reconnaissance, observation, bombardment, landing, and practice firing for antiaircraft guns. While details of flares vary from model to model, flares for illumination (fig. 9-3) have certain characteristics in common.

(1) Candlepower. Flares produce white or colored lights of intensities ranging from 60,000 candlepower for 1 minute to 3,000,000 candlepower for 3 minutes.

(2) Parachutes. Most flares are parachutes supported to retard speed of fall and provide a longer interval of illumination.

(3) Ignition. All flares have a form of delayed ignition to assure their clearing the aircraft or reaching a specified altitude before starting to burn. Delayed ignition is effected by a mechanical time fuze, a quick match, or delay fuze initiated by the pressure which occurs when the parachute opens. Another method depends upon an expelling charge which concurrently ejects the candle and parachute assemblies from the flare case and initiates the ignition train (fig. 9-2).

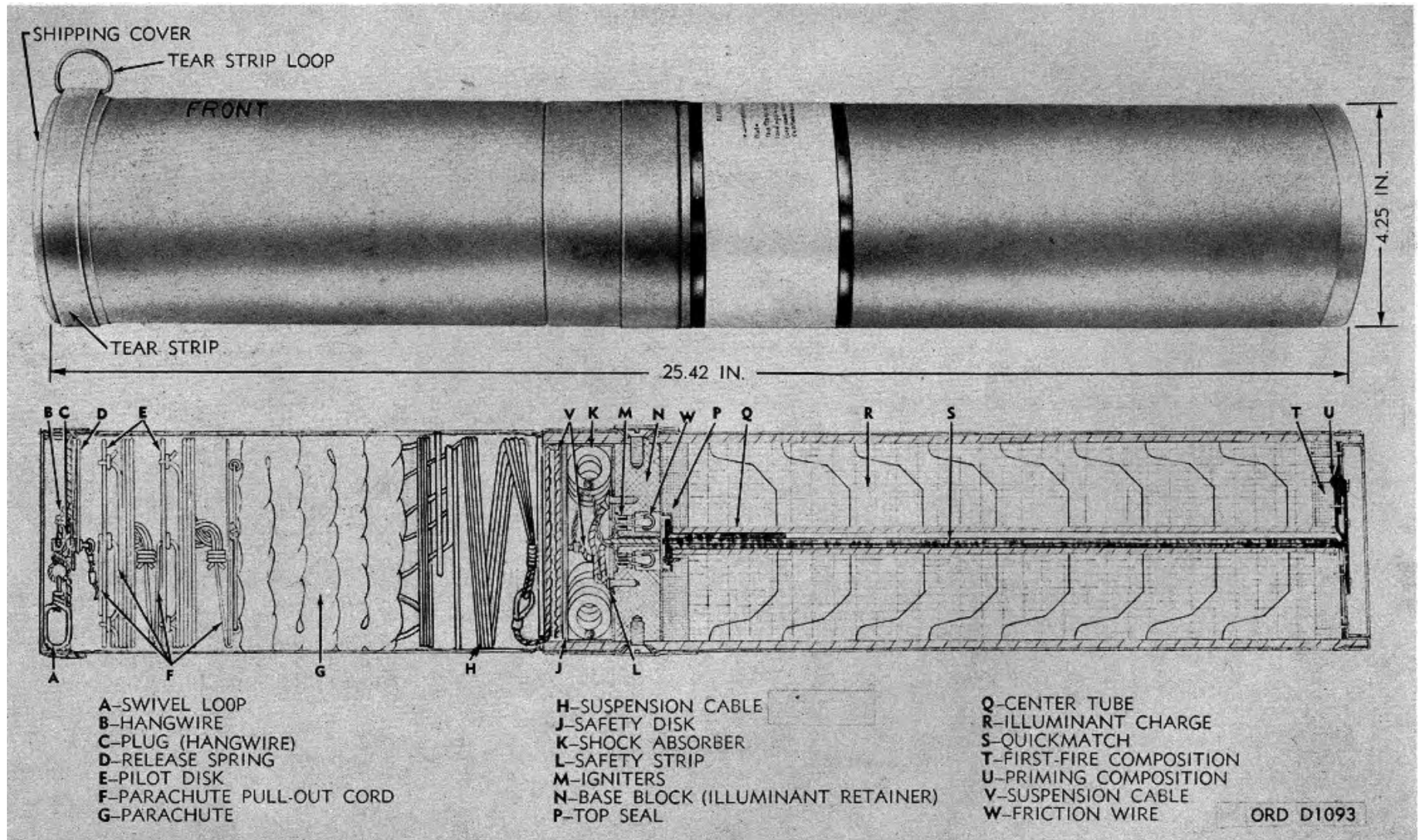

Figure 9-3. Aircraft parachute (illuminating) flare.

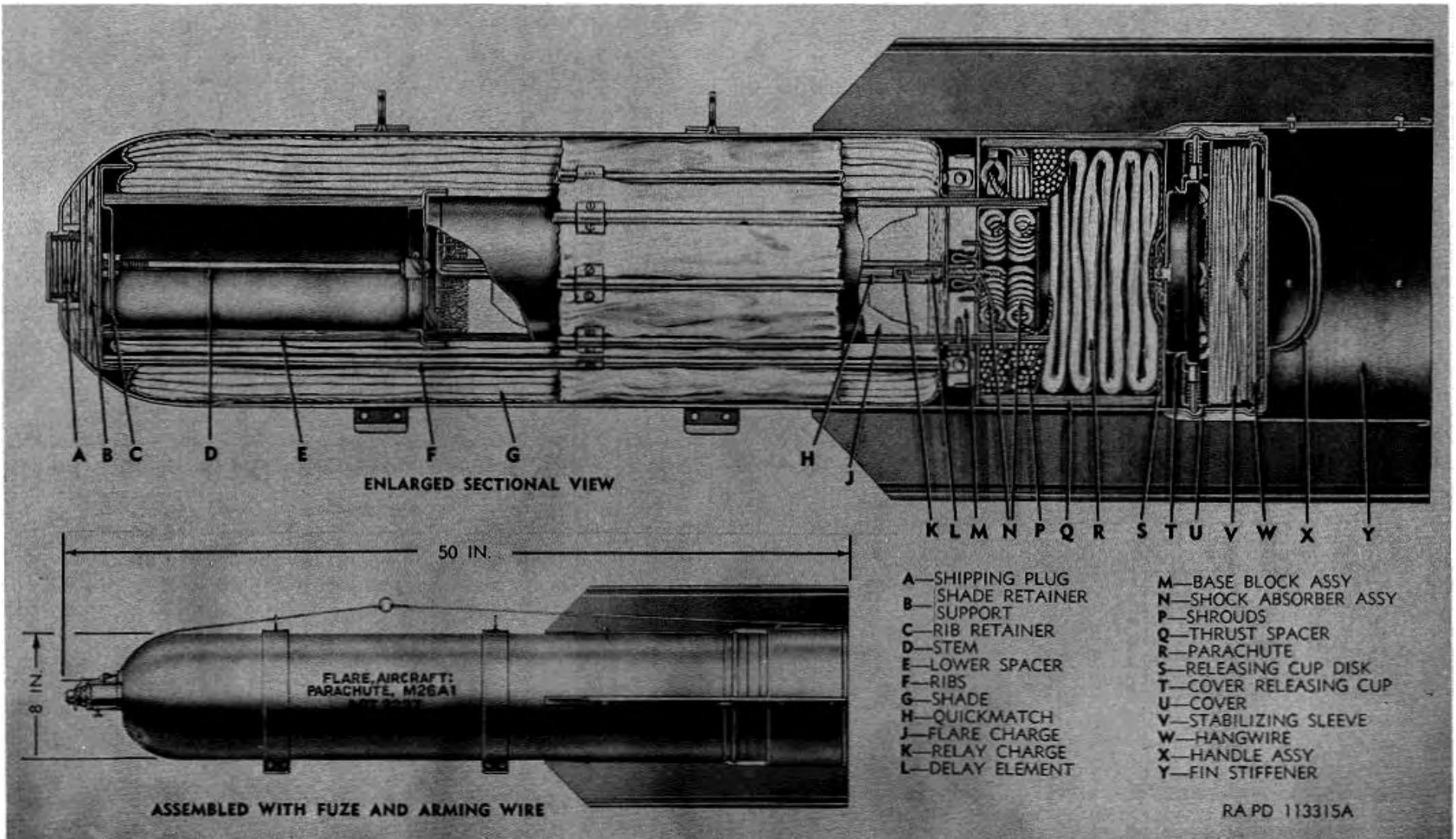

Figure 9-4. Aircraft parachute flare with shade.

b. Certain flares used below the aircraft, as in bombardment, are provided with shades (fig. 9-4) to shield bombardiers from the glare.

c. Flares released from aircraft launching tubes or racks are equipped with an arming wire, hangwire, firing lanyard, or rip cord assembly, each of which is attached to the arming pawl of the tube or rack. Flares may be released armed or safe. When the flare is released armed, the hang-wire remains attached to the aircraft and actuates the flare. If released safe, the flare will not function in the air but may ignite on impact. This possibility must be kept in mind when releasing flares over friendly territory. When an arming wire is employed, it remains attached to the aircraft and allows the fuze to arm.

d. Towed flares are used as assembly markers in aircraft flight formation. These flares function like other aircraft flares, except that they are towed by the aircraft at the end of a 60-foot length of steel cable or manila rope.

9-6. Ground Flares

Ground flares are designed for illumination of aircraft landings in emergency fields, for lighting airports in case of power failure, or to warn of attempted infiltration by enemy troops. Certain ground flares, such as fusees, may be used as recognition signals. The following are representative:

a. The *airport flare* (fig. 9-5), a 20-pound, cylindrical charge of illuminant (candle) encased in a zinc-sheathed, box-board tube fitted with a means of ignition. It burns with a yellow flame visible for 5 to 7 minutes at a distance of 20 to 30 miles, depending upon atmospheric conditions.

b. The *red fusee*, a 20-minute, red-fire candle, used to outline airport boundaries.

c. *Surface trip flares*, outwardly resembling antipersonnel mines or hand grenades (fig. 9-6). These are used primarily to warn of infiltrating troops by illuminating the field. They are also employed as signals and -may be used as boobytraps.

9-7. Guide Flares

Guide flares are electrically ignited flares intended for use with bombs. The red, green and white flares (fig. 9-7) are similar, except for color, markings and candlepower. They burn for 45 to 60 seconds and produce from 650,000 to 900,000 candlepower.

9-8. Ramjet Engine Igniters

Ramjet engine igniters (fig. 9-8) are electrically ignited pyrotechnic items used to ignite fuel-air mixtures in ramjet engines of guided missiles. They contain a pyrotechnic composition that releases sufficient heat to maintain ignition of the fuel-air mixtures for 10 to 90 seconds, depending on the specific model.

9-9. Tracking Flares

Tracking flares are used in tracing the path of guided missiles. They have nominal burning times of 75 to 95 seconds with 70,000 to 150,000 candlepower.

9-10. Signals

Pyrotechnic signals are designed to produce light of various intensities, duration and color; smoke of various colors and densities; sound of various degrees; or any combination of these. Signals may consist of a single parachute-supported star or a number of free-falling stars or clusters of various colors. Smoke signals are usually of the slow burning type designed to leave trails of smoke. For complete information on signals, see TM 9-1370-203-20&P For a guide to the employment of pyrotechnic illuminating devices, see pertinent field manual.

a. *Tactical Aircraft Signals.* Aircraft signals used directly in connection with combat operations were originally intended for air-to-air or air-to-ground signaling. However, since the introduction of pyrotechnic pistols and hand-held pyrotechnic projectors, aircraft signals have been used by ground troops for ground-to-ground and ground-to-air signaling. Single-star signals, double-star signals, and tracer-double-star signals (fig. 9-9) contain green, red or yellow candles of pyrotechnic composition. Stars may be distinguished at distances of approximately 5 miles at night and 2 to 3 miles in daylight. Total burning time is 7 to 13 seconds for both single-star and double-star signals. The tracer in the tracer-double-star signals burns for 2 1/2 to 4 seconds; each star burns for 3 to 4 1/2 seconds.

b. *Distress Signals.* Marine signals, generally used for distress signaling, produce illumination (stars) for night use; a brilliant orange smoke for day use; or a combination of stars and smoke for either day or night use. Marine signals (fig. 9-10), generally small enough to be carried in the pocket of life vests, flight suits or life rafts, are designed for firing by hand or pistol.

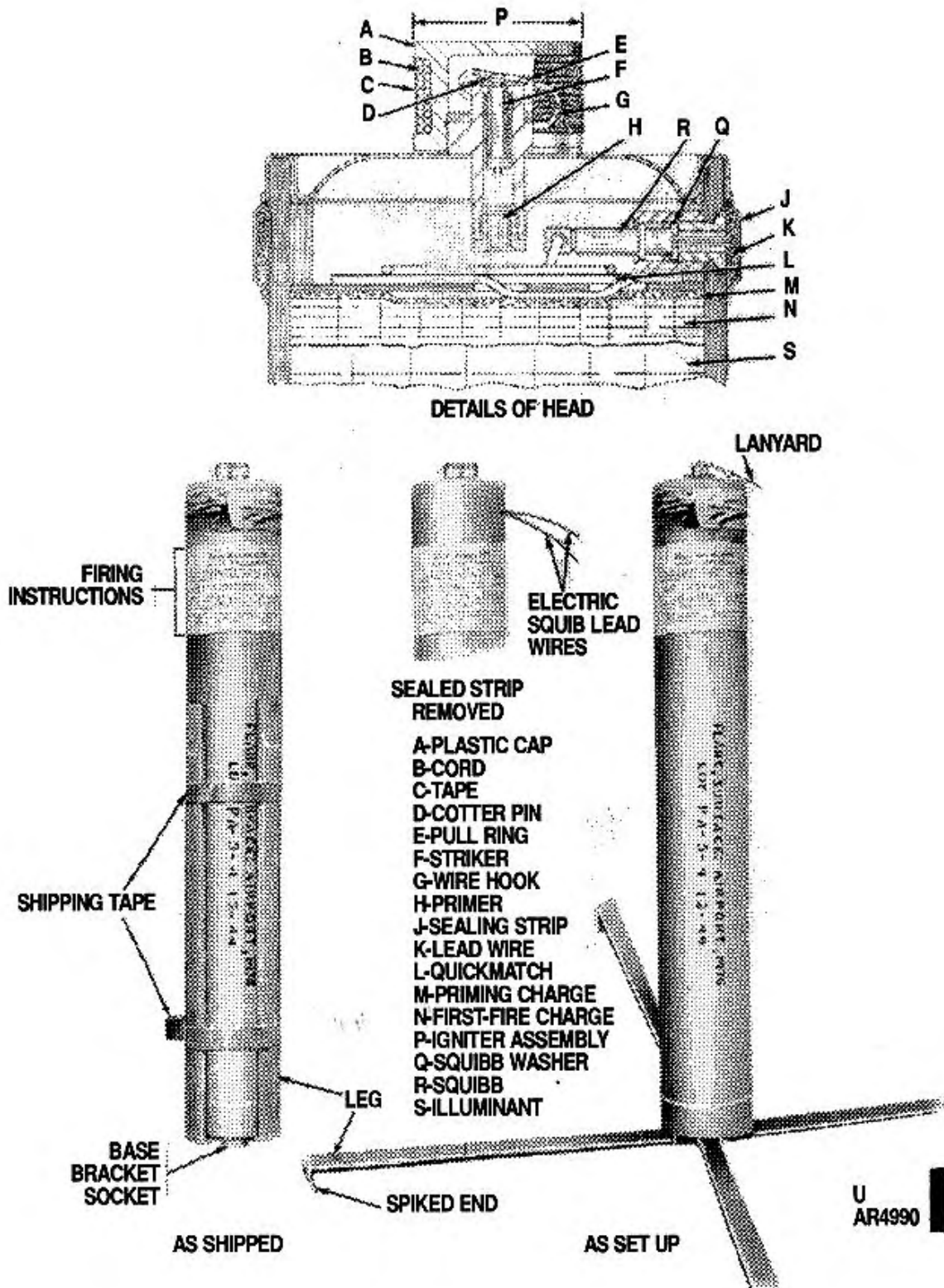

Figure 9-5. Airport flare.

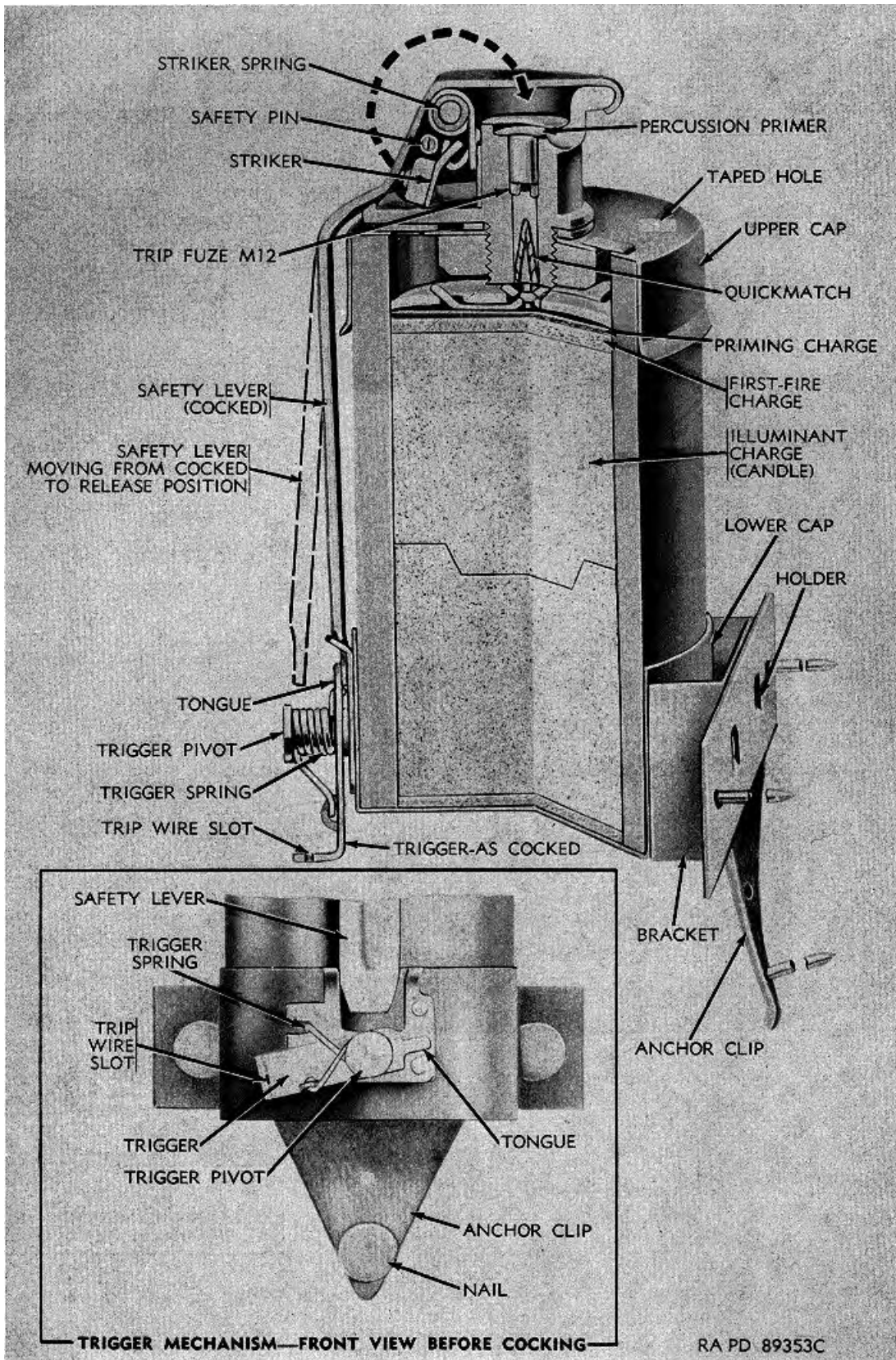

Figure 9-6. Surface trip flare.

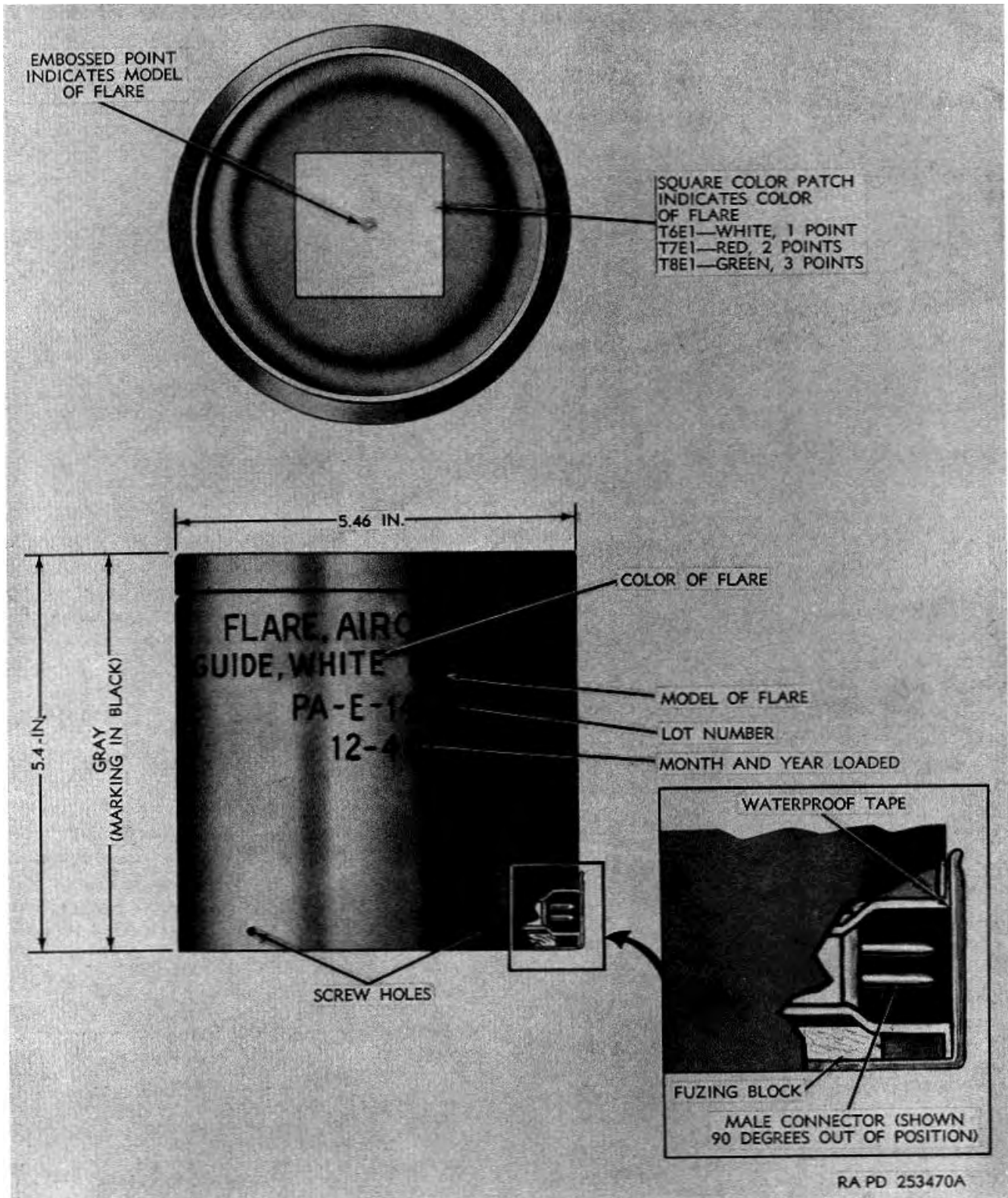

Figure 9-7. Guide flare.

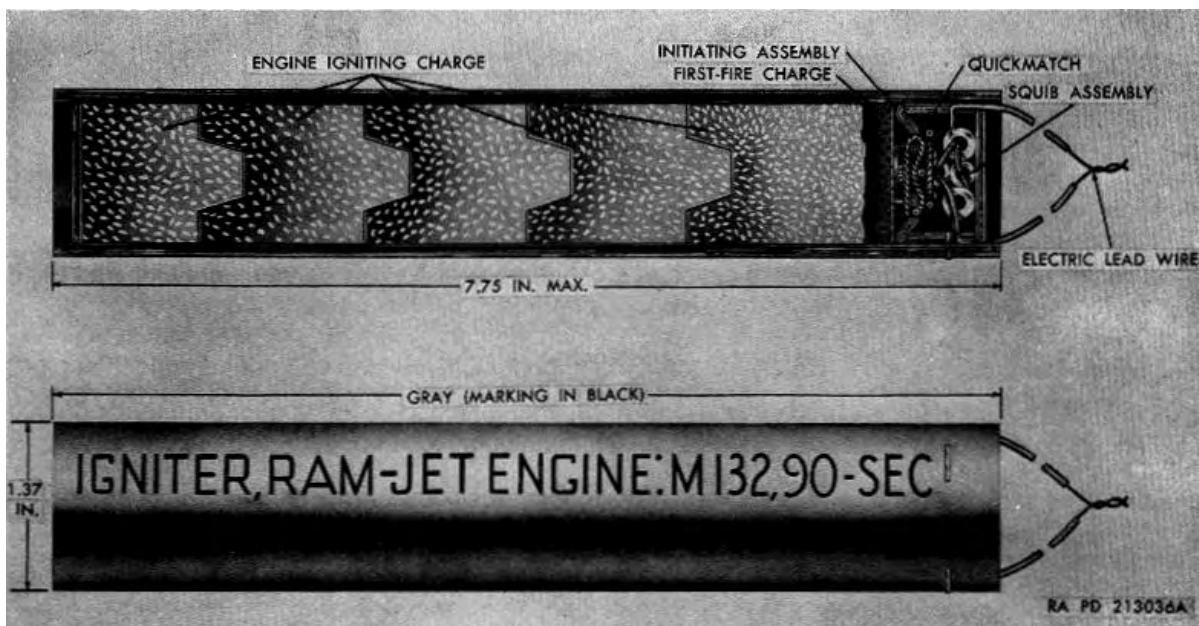

Figure 9-8. Ramjet engine igniter.

c. *Drift Signals, Markers and Lights.* These pyrotechnic devices aid in navigation of aircraft over water by providing a stationary reference point. They are also used to mark the location for emergency landing at night. The signals contain a pyrotechnic candle that ignites on impact. Floating nose down, the signals emit flame and smoke from the tail. One type of marker produces a slick on the water surface. The other types, which produce smoke and flame, are called night drift signals or aircraft float lights. Drift signals and markers are thrown overboard from an aircraft.

(1) The slick marker is for daytime use and contains a 21/4-pound cylinder of uramine, a soluble dye salt, in a brittle plastic case. The marker, although not a pyrotechnic, has a somewhat similar effect. It produces a colored film or slick on the surface of the water when the case is shattered by impact. The yellowish-green, fluorescent slick produced by the uramine is approximately 20 feet in diameter. The slick persists for at least 2 hours and can be seen 10 miles away from an altitude of 3,000 feet.

(2) Night drift signals (fig. 9-11), identified as aircraft smoke and illumination signals, produce flame and smoke which can be observed on a clear day for a distance of 6 or 7 miles. A representative signal has a flat-faced, metal tail fin assembly. The body contains from 1 to 3 candle units which burn from 180 to 900 seconds, depending on the model.

(3) The aircraft float light (fig. 9-12) provides a long-burning surface marker for night or day use. It may be thrown overboard from an aircraft or launched from wing racks. The signal contains four, 3-unit pyrotechnic candles which emit flame and smoke through a hole in the base of the body.

d. *Ground Signals.*

(1) Grenade-launcher ground signals (fig. 9-13) are projected from a grenade launcher attached to Rifle M1 or M14. A propelling charge in the signal supplements a special blank cartridge (the standard grenade cartridge) supplied with the signal, to attain the required altitude. The signal rises to a height of 600 to 700 feet before functioning.

(a) The parachute-supported star signal produces a single star that burns from 20 to 80 seconds. Different models produce amber, green, red or white stars. Candlepower and visibility vary according to the color of the star.

(b) The cluster-type star signal produces five free-falling stars, all of one color, with a burning time of 4 to 10 seconds. Different cluster models produce stars of the same colors as the single-star parachute models. Parachute and cluster signals are similar in appearance and design.

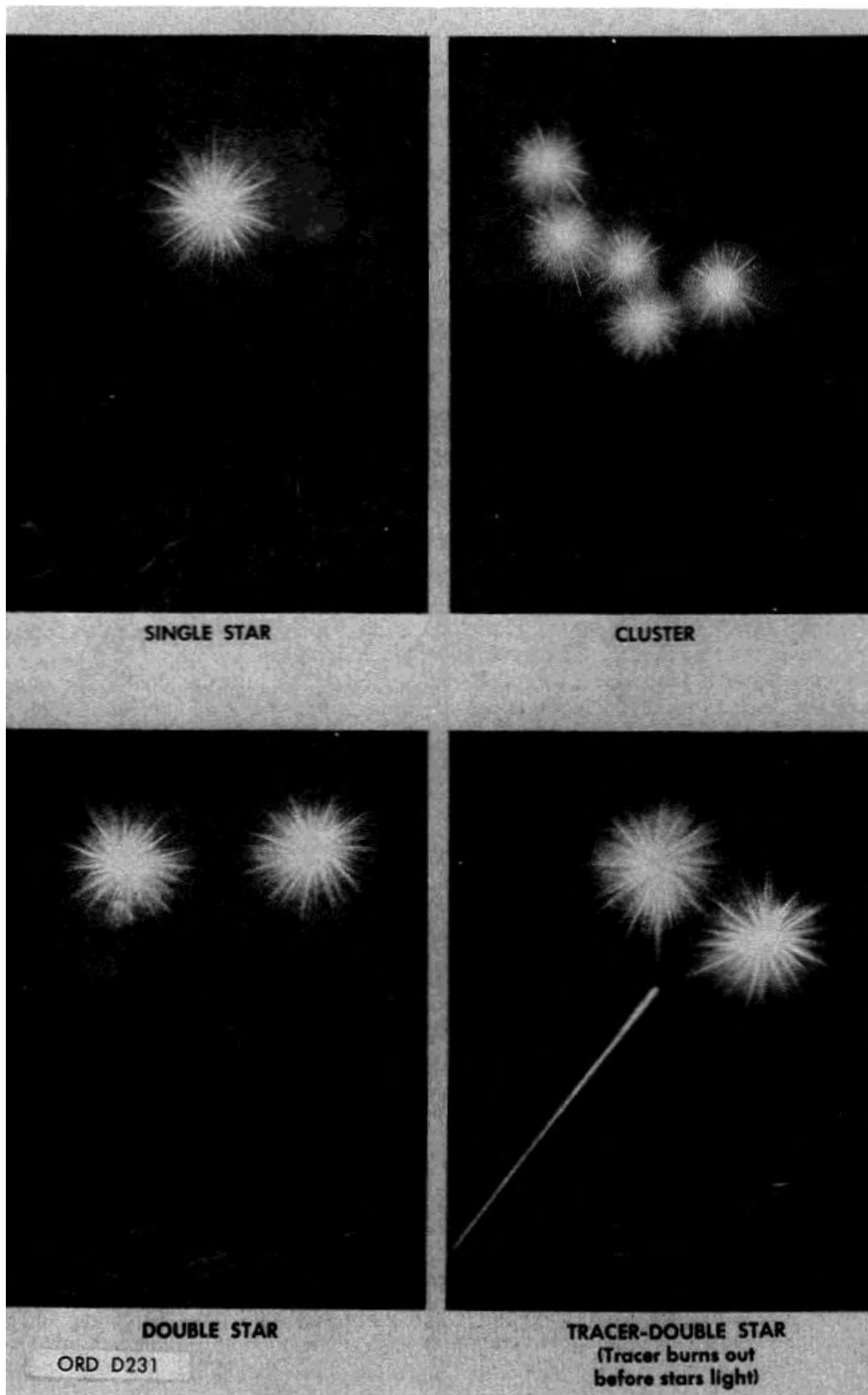

Figure 9-9. Aircraft signal patterns.

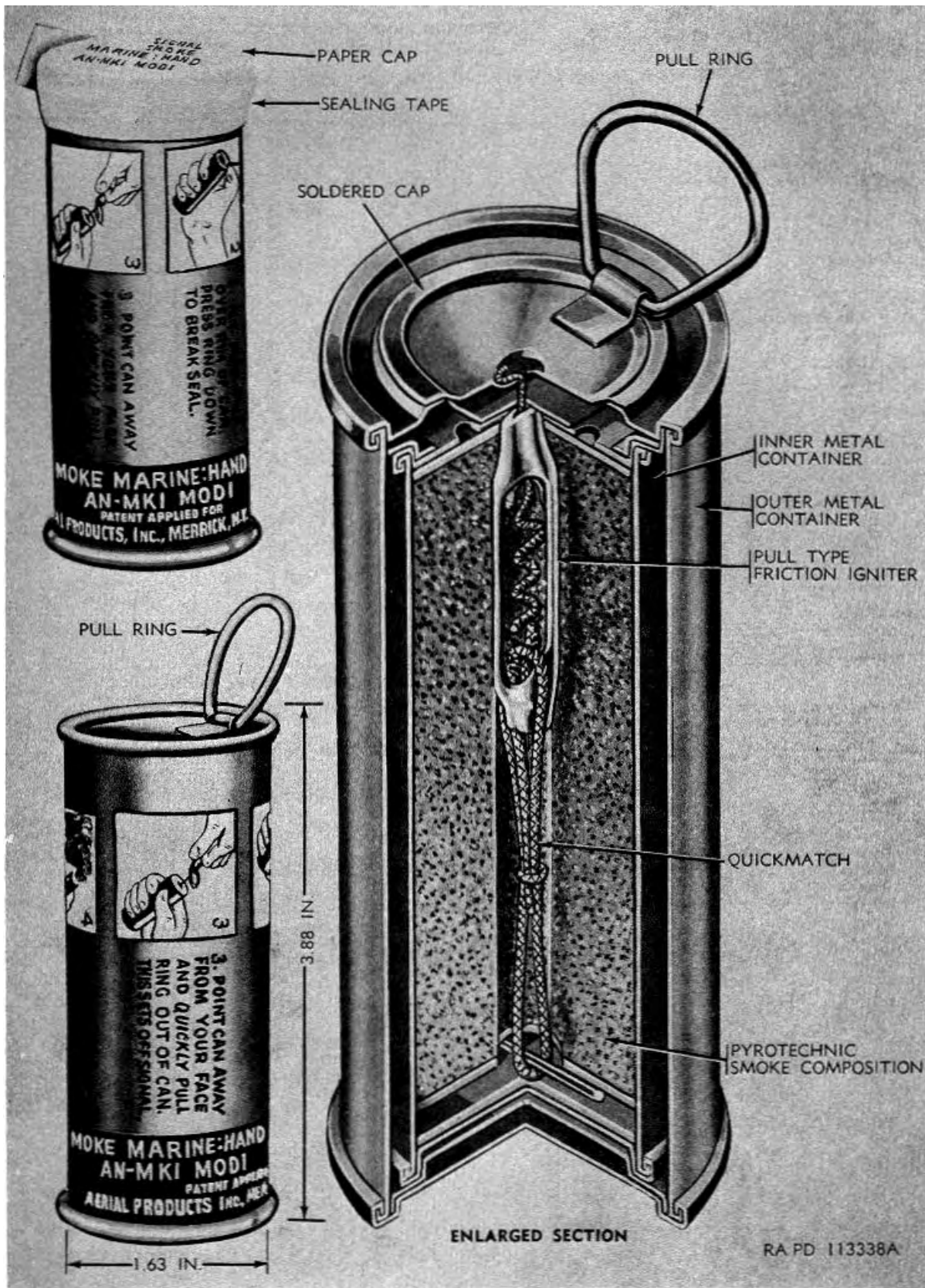

Figure 9-10. Handheld marine smoke signal.

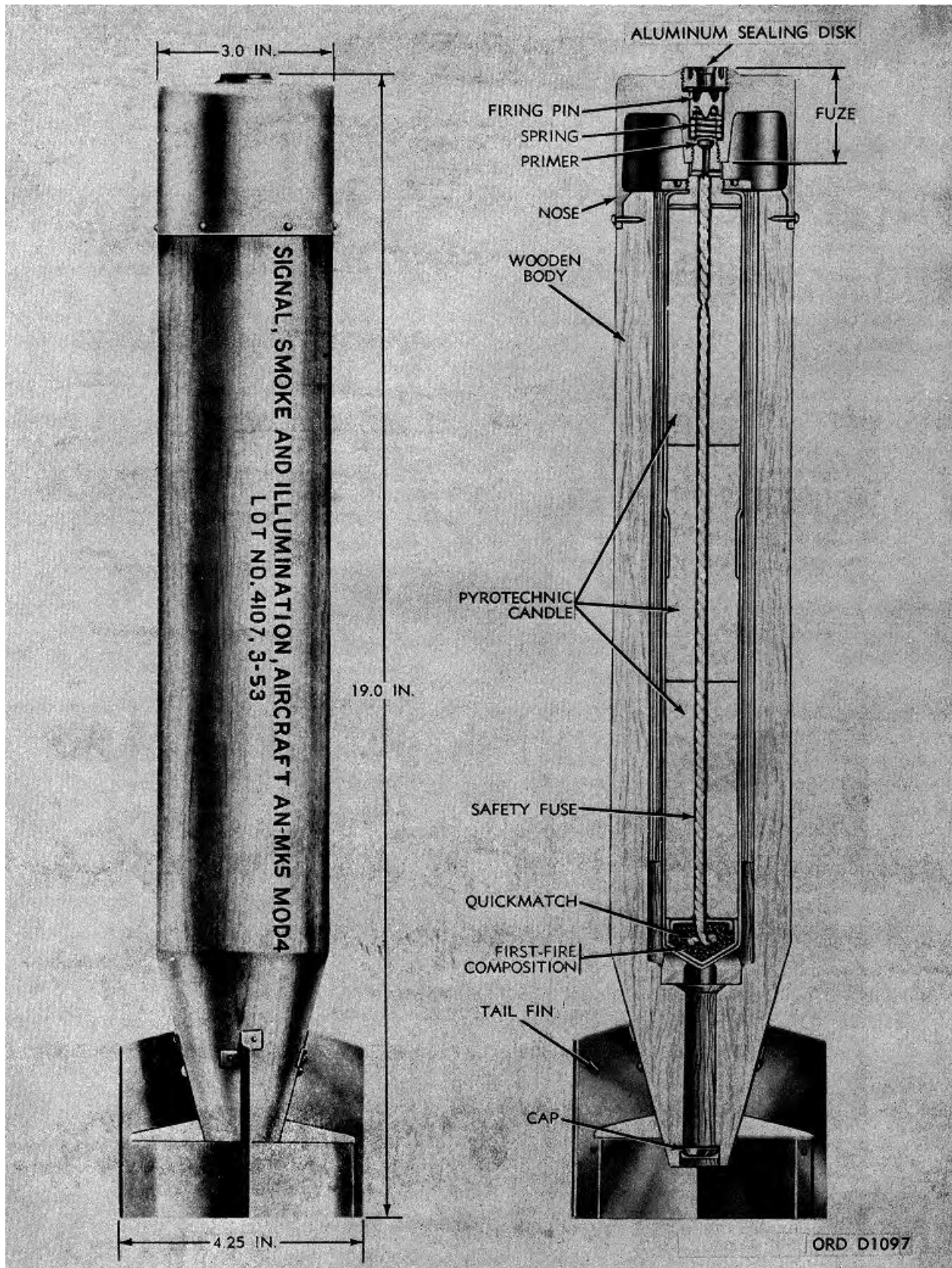

Figure 9-11. Night drift signal.

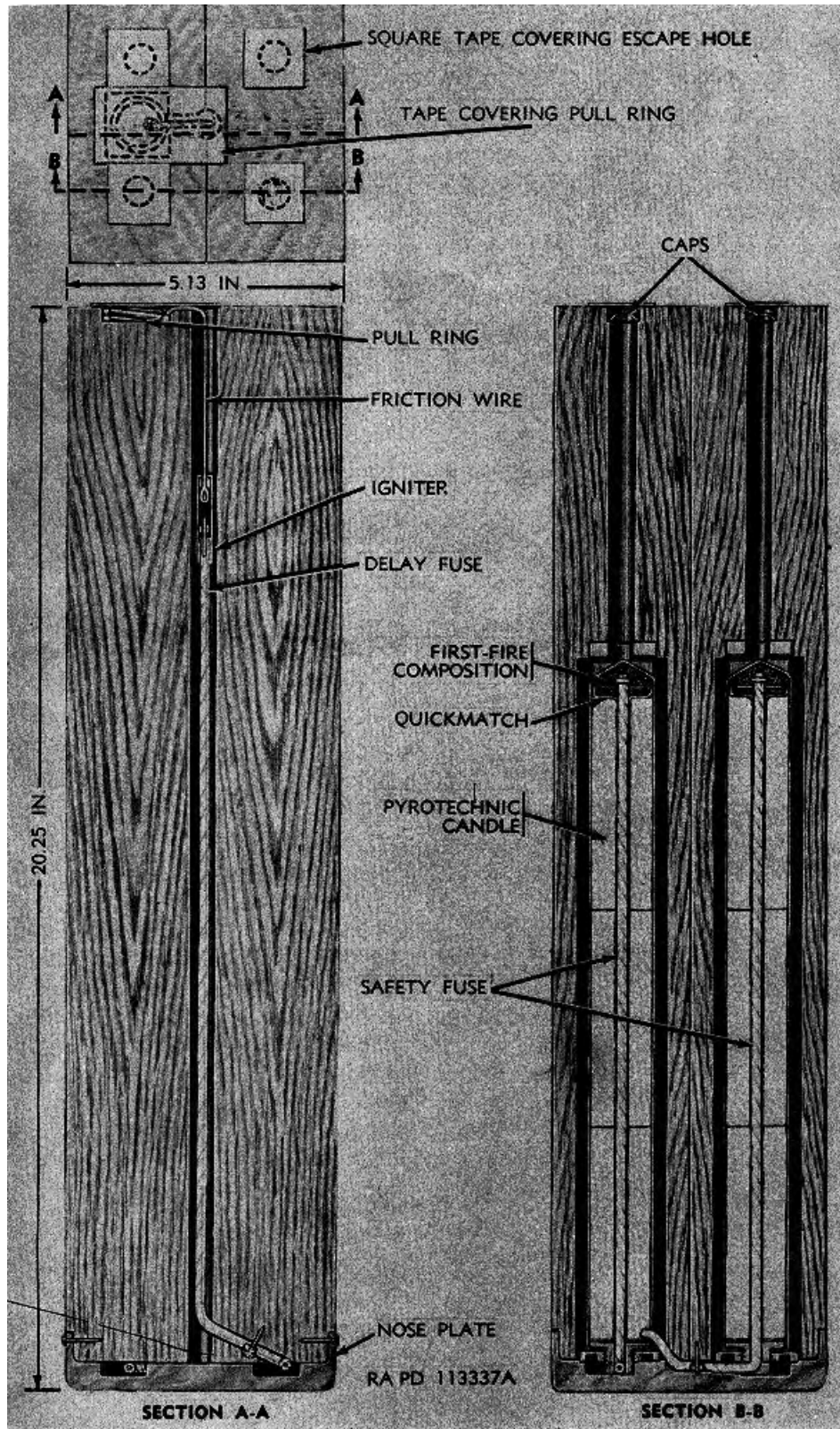

Figure 9-12. Aircraft float light.

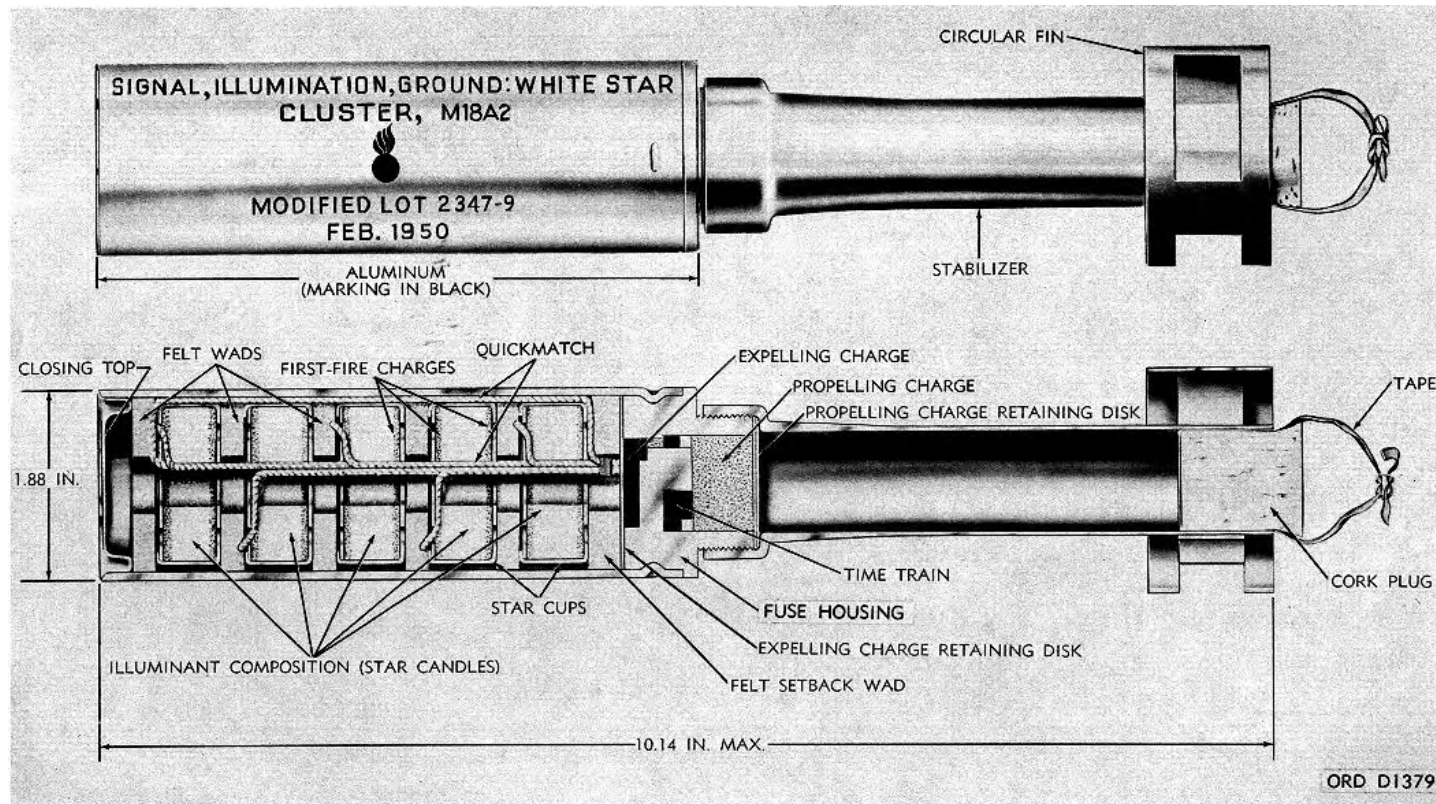

Figure 9-13. Grenade-launcher ground signal.

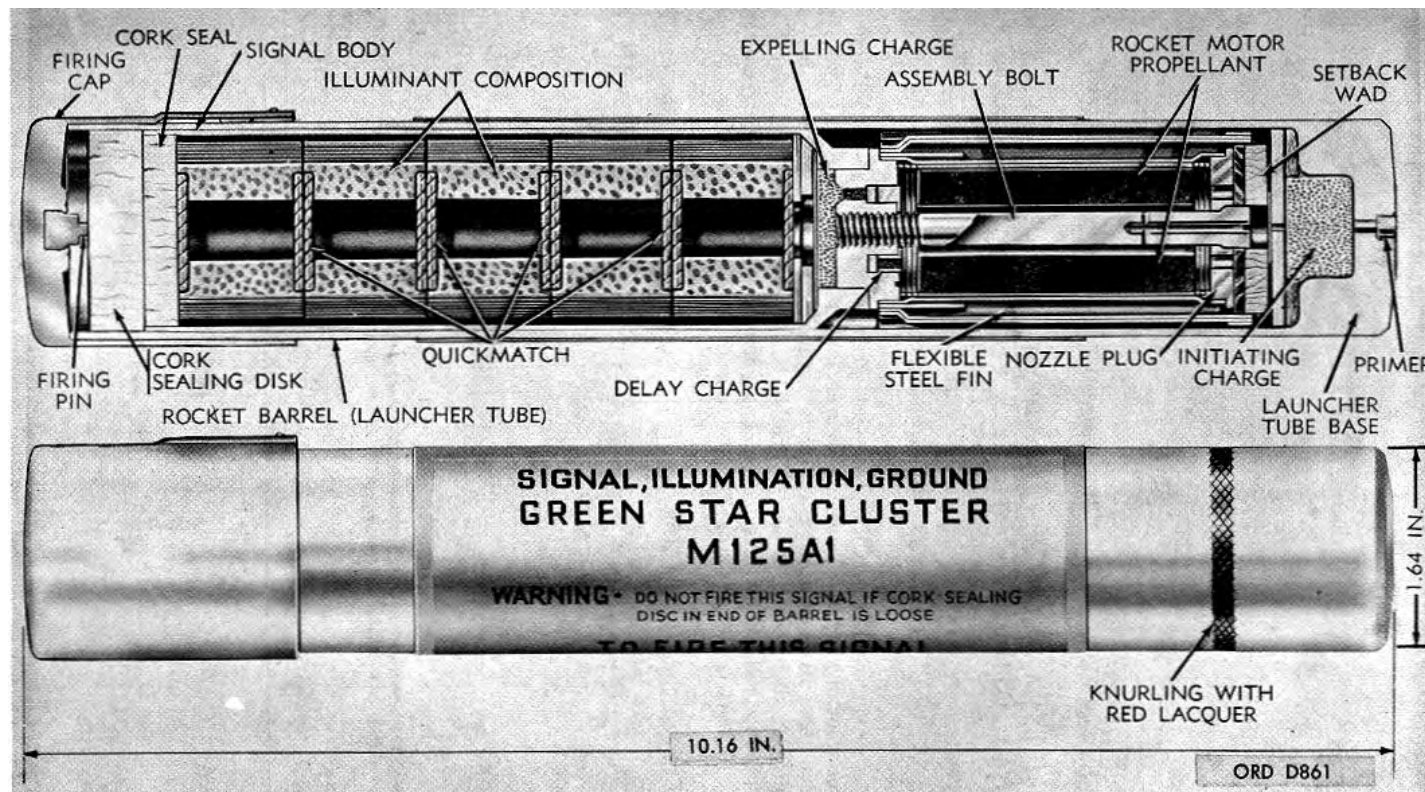

Figure 9-14. Rocket-propelled ground signal.

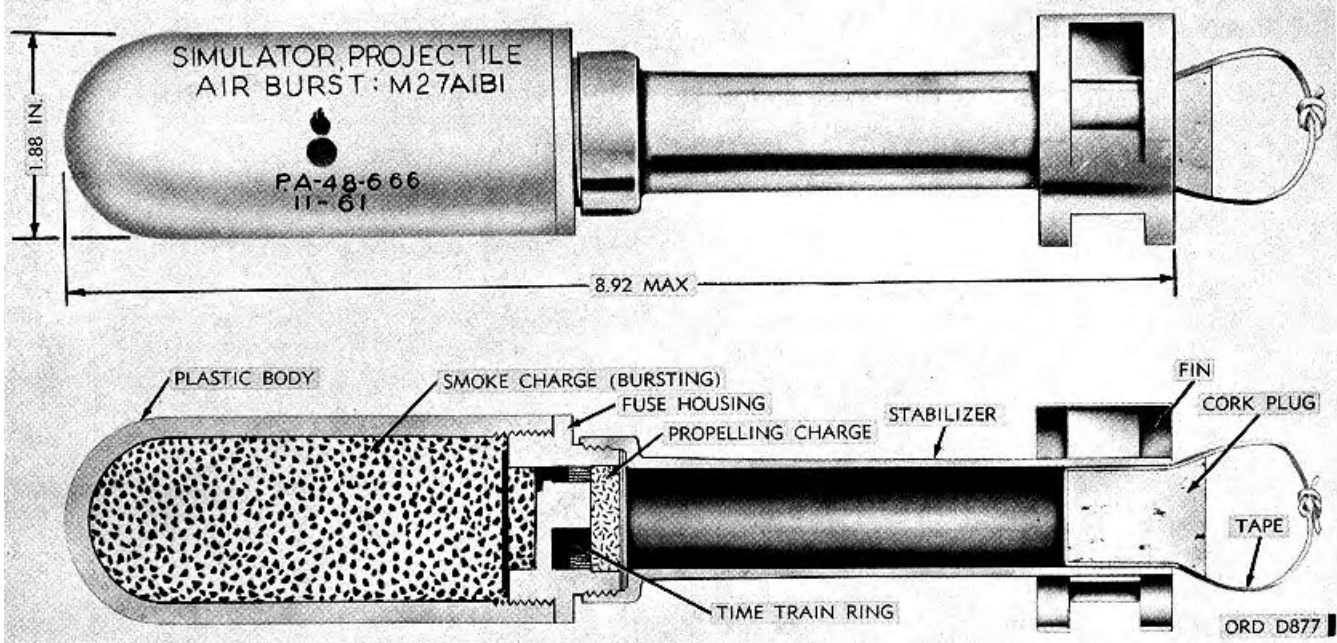

Figure 9-15. Air burst simulator.

(c) Smoke signals produce six free-falling smoke pellets of the same color. Each pellet leaves a stream of colored smoke that extends approximately 250 feet. The burning time is 4 to 8 seconds. Different models produce red, yellow, green and violet colored smoke. (Violet is used for training or demonstrations only.)

launching mechanisms. The signals are composed of three main units: an aluminum rocket barrel; a firing cap with firing pin; and the signal, which includes the body, rocket motor, and folding-fin stabilizing device. The signals rise to a height of 650 to 750 feet.

(a) Parachute star signals, used for battlefield illumination, produce a

(2) Rocket-propelled ground signals (fig. 9-14) are hand-held, fin-stabilized signals with integral

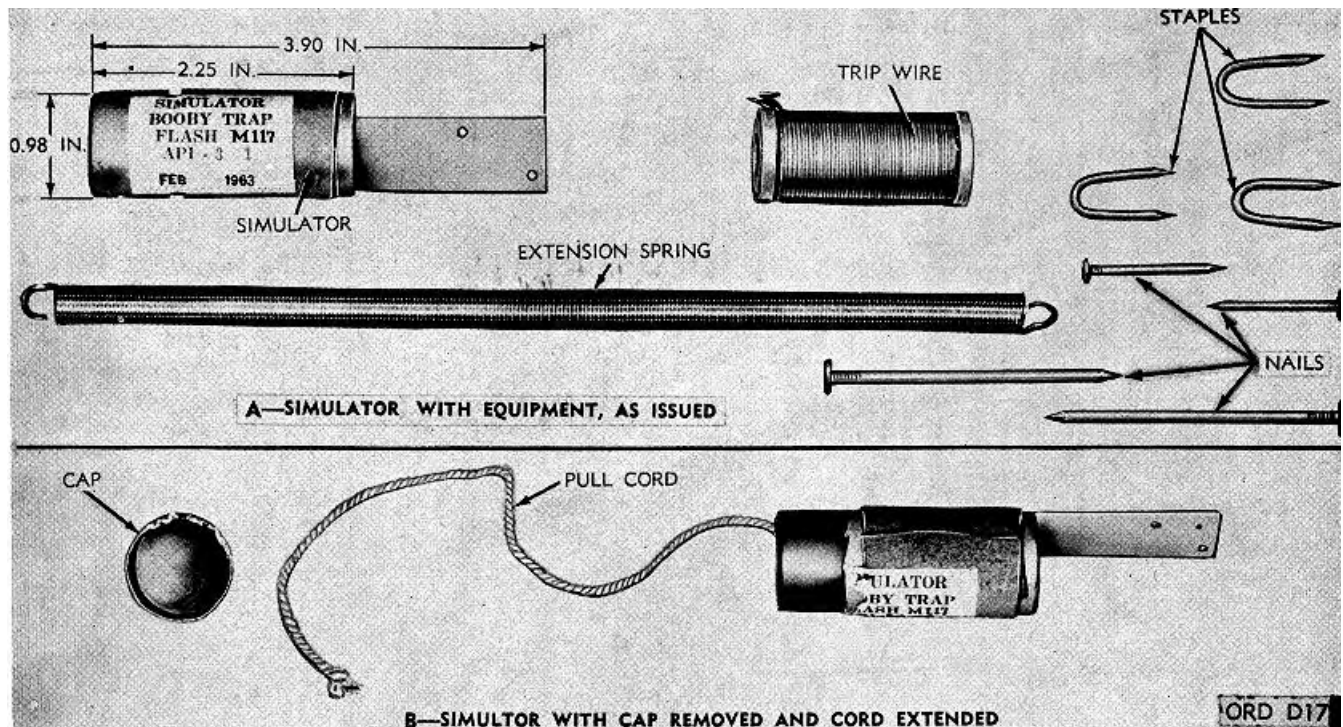

Figure 9-16. Boobytrap simulator.

parachute-supported red or white star. Red stars burn at 16,000 candlepower for a minimum of 50 seconds; white stars, at 125,000 candlepower for 25 seconds.

(b) Cluster star signals produce five free-falling green, red or white stars that burn 8 ± 2 seconds.

(c) Smoke parachute signals, which produce a single red or green parachute-supported smoke pellet, emit smoke for 6 to 18 seconds. They produce a smoke cloud which lasts approximately one minute.

9-11. Photoflash Cartridges

a. *General.* These cartridges, fired from electrically powered projectors, are used in connection with aerial photography during reconnaissance missions.

b. *Service Cartridge.* A service photoflash cartridge consists of an electrically primed cartridge case containing a cased photoflash charge and delay fuse assembly, and a small propelling charge.

c. *Practice Cartridge.* A practice photoflash cartridge consists of a solid, inert unit and a small propelling charge in an electrically primed cartridge case.

9-12. Training Pyrotechnics

a. Pyrotechnic items used as training devices include tow-target flares, aircraft parachute flares, photoflash cartridges, and a variety of simulators.

b. Simulators are used to create the effect of specific items of ammunition. The primary types of simulators are described briefly below.

(1) The *air burst simulator* (fig. 9-15), used with a smoke puff discharger, simulates the burst of an artillery projectile near the ground by producing a puff of white smoke.

(2) The *boobytrap simulator* (fig. 9-16) is used during maneuvers and troop training. This device provides training in installation and use of boobytraps. When triggered, the simulator functions with a loud report and flash.

(3) The *ground burst simulator* (fig. 9-17) is used to create battle noises and effects during troop maneuvers. It produces a high-pitched whistle which lasts 2 to 4 seconds. In exploding, it produces a flash and loud report.

(4) The *artillery flash simulator* (fig. 9-18) produces a flash, a puff of smoke, and a loud report. Its flash is similar to that of 90-mm guns and 155-mm howitzers. This simulator is used to train artillery observers and may actually be employed in forward combat areas as a decoy.

(5) The *hand grenade simulator* (fig. 9-19) provides battle noises and effects during troop maneuvers. It is thrown in the same manner as a live grenade and creates a loud report and flash 5 to 10 seconds after ignition.

(6) The *explosive simulator* (fig. 9-20) is

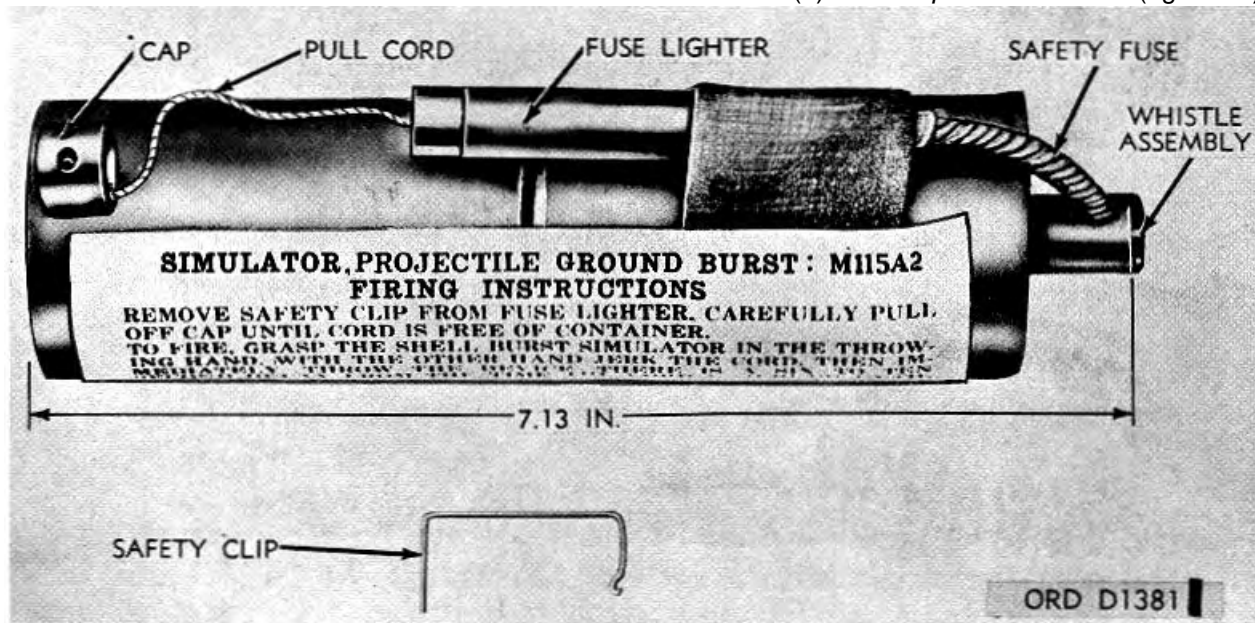

Figure 9-17. Ground burst simulator.

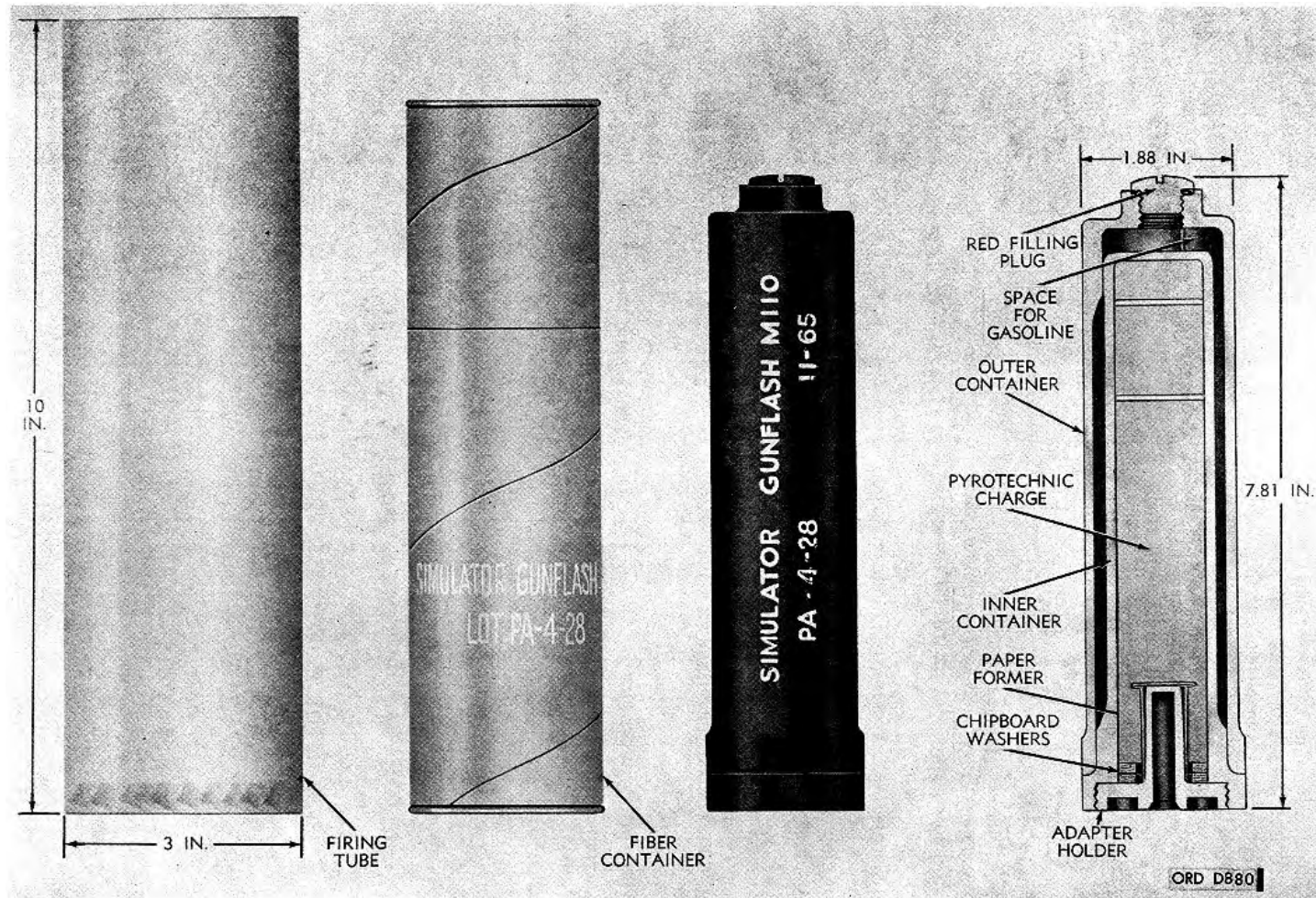

Figure 9-18. Artillery flash simulator.

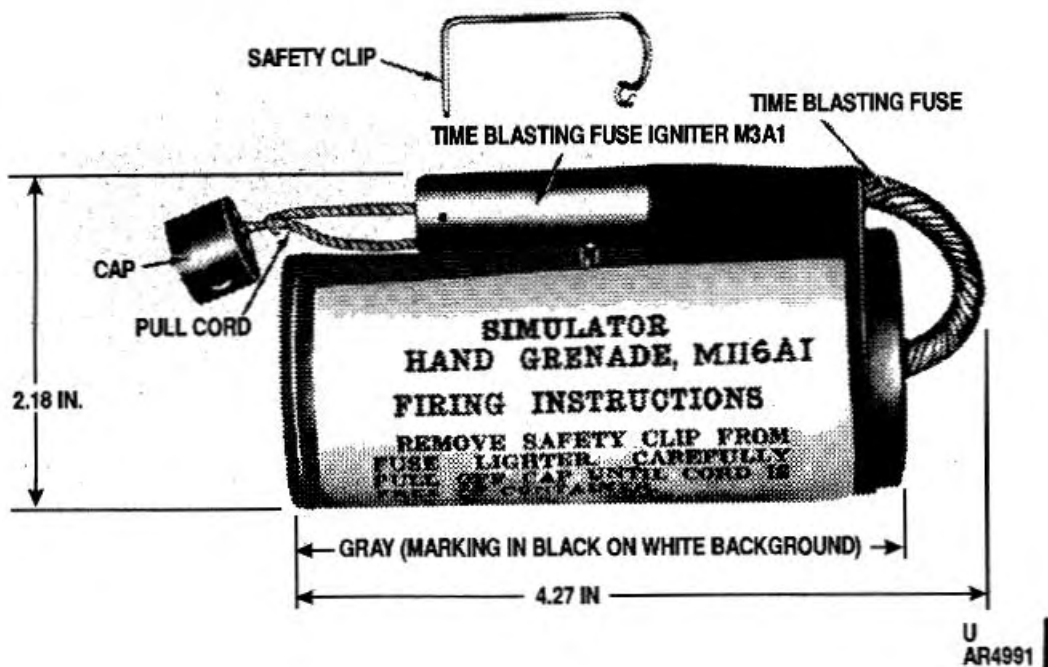

Figure 9-19. Hand grenade simulator.

used in boobytraps, land mine detection and deactivation training programs. It is used to simulate hand grenades, boobytraps, land mines, and rifle or artillery fire.

9-13. Care and Precautions in Handling

a. General. Pyrotechnic compositions are particularly susceptible to deterioration by moisture. They are especially hazardous since they ignite more readily than other types of high explosives. Information

concerning precautions in handling pyrotechnics is contained in TM 9-1300-206 and TM 9-1370-203-20&P.

b. Types of Pyrotechnics. The specific precautions in (1) through (3) below apply to the type of pyrotechnic indicated.

- (1) Flares.

(a) Avoid damage to fiber cases and rip cords located outside casing of certain types of flares.

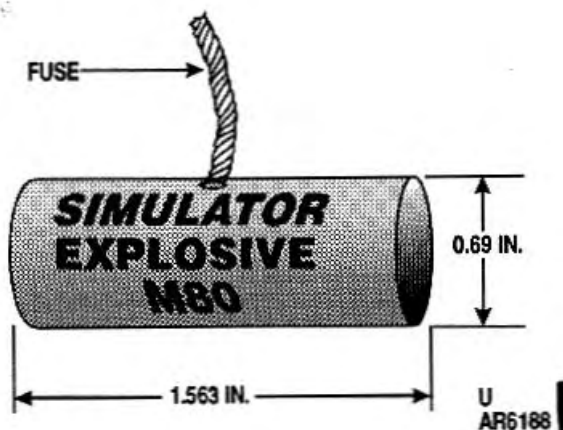
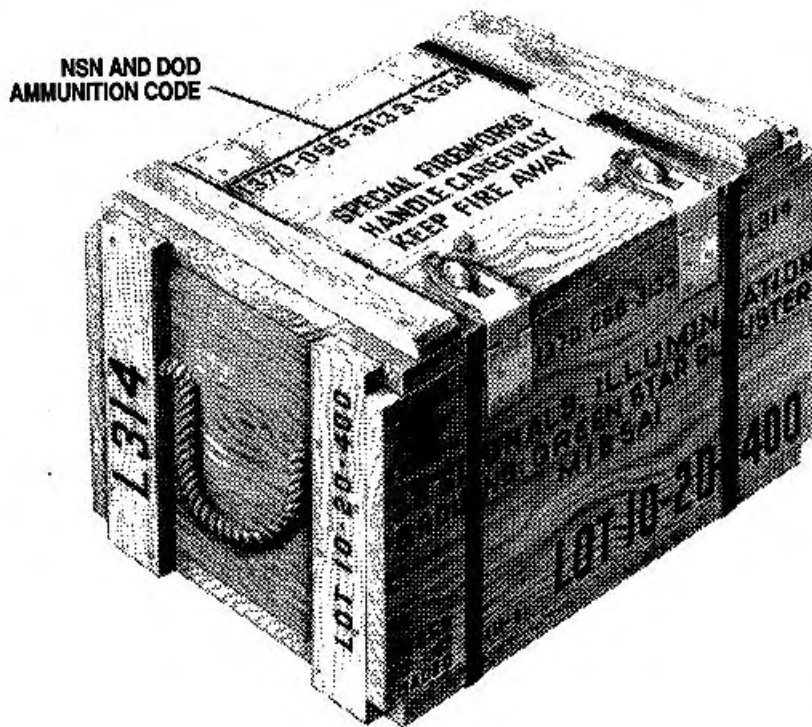
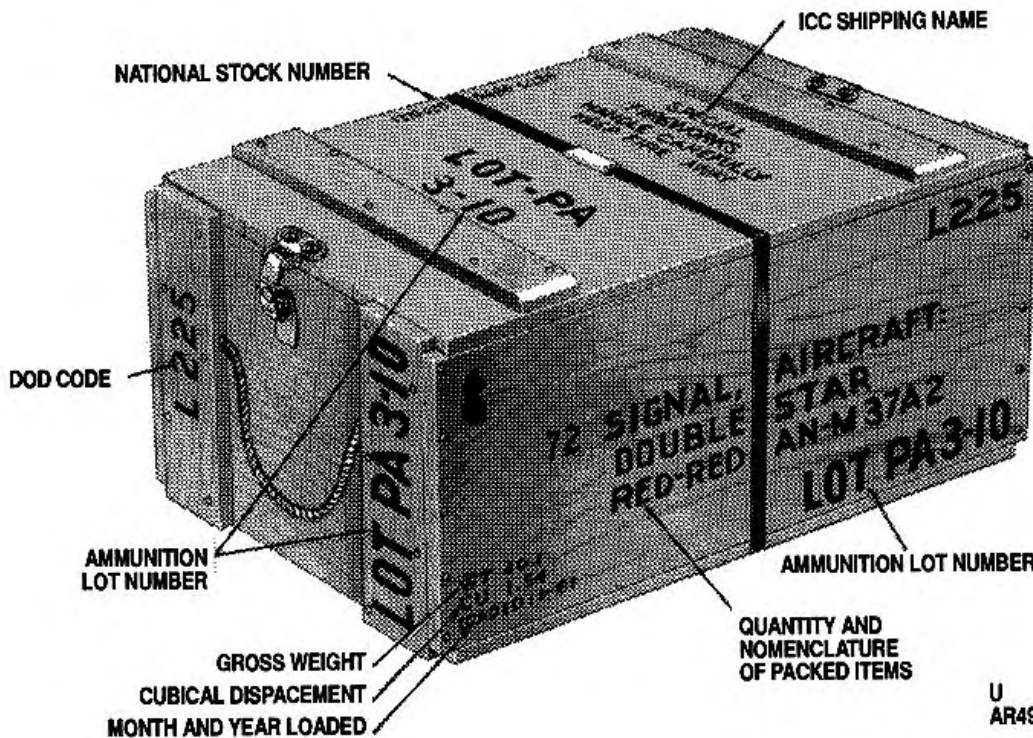

Figure 9-20. Explosive simulator.



U
AR4992

Figure 9-21. Packing box for ground signals.



U
AR4993

Figure 9-22. Packing box for aircraft signals.

(b) Before lead wires of electrically ignited flares are connected, assure that there is no electrical energy in electrical circuit.

(2) Signals.

(a) Do not use signals with dented,

deformed, or cracked barrels, or with loose closing caps.

(b) Guard against blows to primer, which could ignite signal.

(3) Photoflash Cartridge. Do not remove

shunt cap from cartridge until just prior to loading cartridge into projector.

9-14. Precautions in Firing

a. Fire pyrotechnics in such a manner that burning material or burned out signals will not fall on friendly personnel, into boxes of pyrotechnics or on other ammunition. Exercise care when firing through trees or other obstructions.

b. Anticipate heavy recoil when firing projected pyrotechnics (except rocket-propelled ground signals).

c. Observe safety precautions found in TM 9-1370-

203-20&P. For regulations in firing ammunition, see AR 385-63.

9-15. Packing and Marking

a. Pyrotechnics are packed and marked in accordance with Department of Transportation Regulations and pertinent specifications and drawings. Inner and outer packings are designed to withstand conditions ordinarily encountered in handling, storage and transportation, and to protect against moisture. Typical packing and markings are illustrated in figures 9-21 and 9-22.

b. Packing and marking data are given in detail in SC 1340/98 - IL and in TM 9-1370-203-20.

THIS PAGE INTENTIONALLY LEFT BLANK

CHAPTER 10

BOMBS

DELETED

THIS PAGE INTENTIONALLY LEFT BLANK

CHAPTER 11

SCATTERABLE MINES

Section I. INTRODUCTION

11-1. General

Scatterable mines are similar in purpose to conventional land mines. Scatterable mines differ, however, in that they are designed for accurate dispersion over a designated area from rotary-wing aircraft, fixed wing aircraft, artillery, and ground dispensers, and lie on the surface of the ground.

scatterable mine system adopted to date. The sequence of operations for the subsystems is depicted in figure 11-1. For information on handling, use, and maintenance of the subsystem refer to TM 9-1345-201-30&P.

11-2. Scope

a. This chapter describes the Mine Dispersing Subsystem, Aircraft: M56, which is the only

b. For operational procedures, refer to TM 91345-201-12.

c. As other systems are adopted their description will be added to this manual.

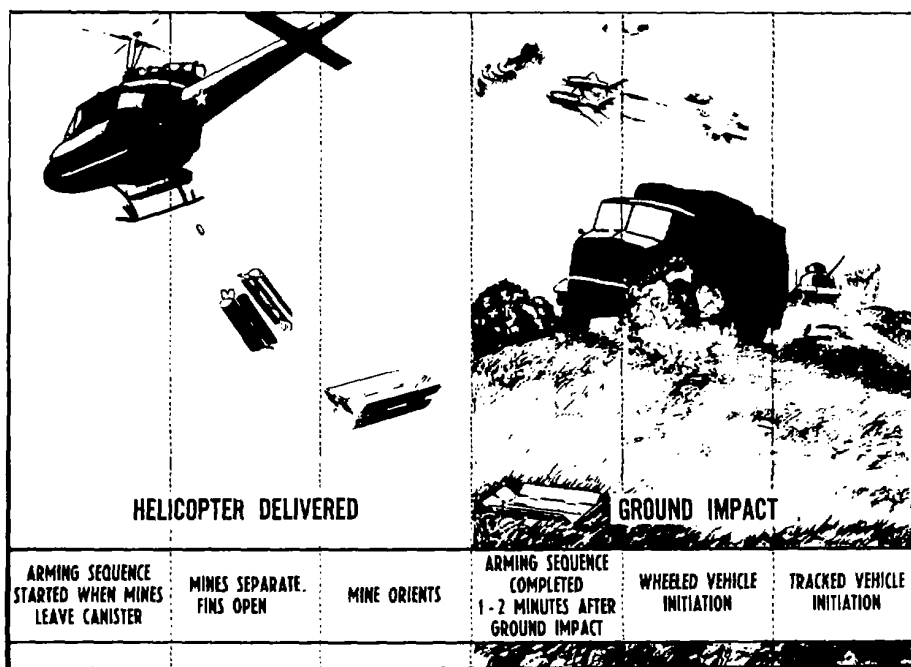

SEQUENCE OF OPERATIONS FOR MINE DISPERSING SUBSYSTEM M56 AR 100645

Figure 11-1. Sequence of mine functioning.

Section II. MINE DISPERSING SUBSYSTEM, AIRCRAFT: M56

11-3. General

The Mine Dispersing Subsystem, Aircraft: M56 (fig. 11-2), consists of bomb (mine) dispenser SUU-13 D/A and a payload of antitank/antivehicular mines in canisters (fig. 11-3). Mine

batteries, which are stored in a refrigerator and which are inserted prior to flight, are shipped separately. The rectangular shaped, electrically-fired sub-system is externally installed on UH-1H aircraft (fig. 11-4). A pallet is attached to the

underside of the subsystem for handling and safety purposes. Initially, the subsystem is issued completely loaded with mines and is packed one per reusable shipping and storage container CNU79/E (fig. 11-5). Loaded replacement mine

canisters (40 to a container) are shipped and stored in mine canister shipping and storage container M602 (fig. 11-6). Both containers are sealed and desiccated.

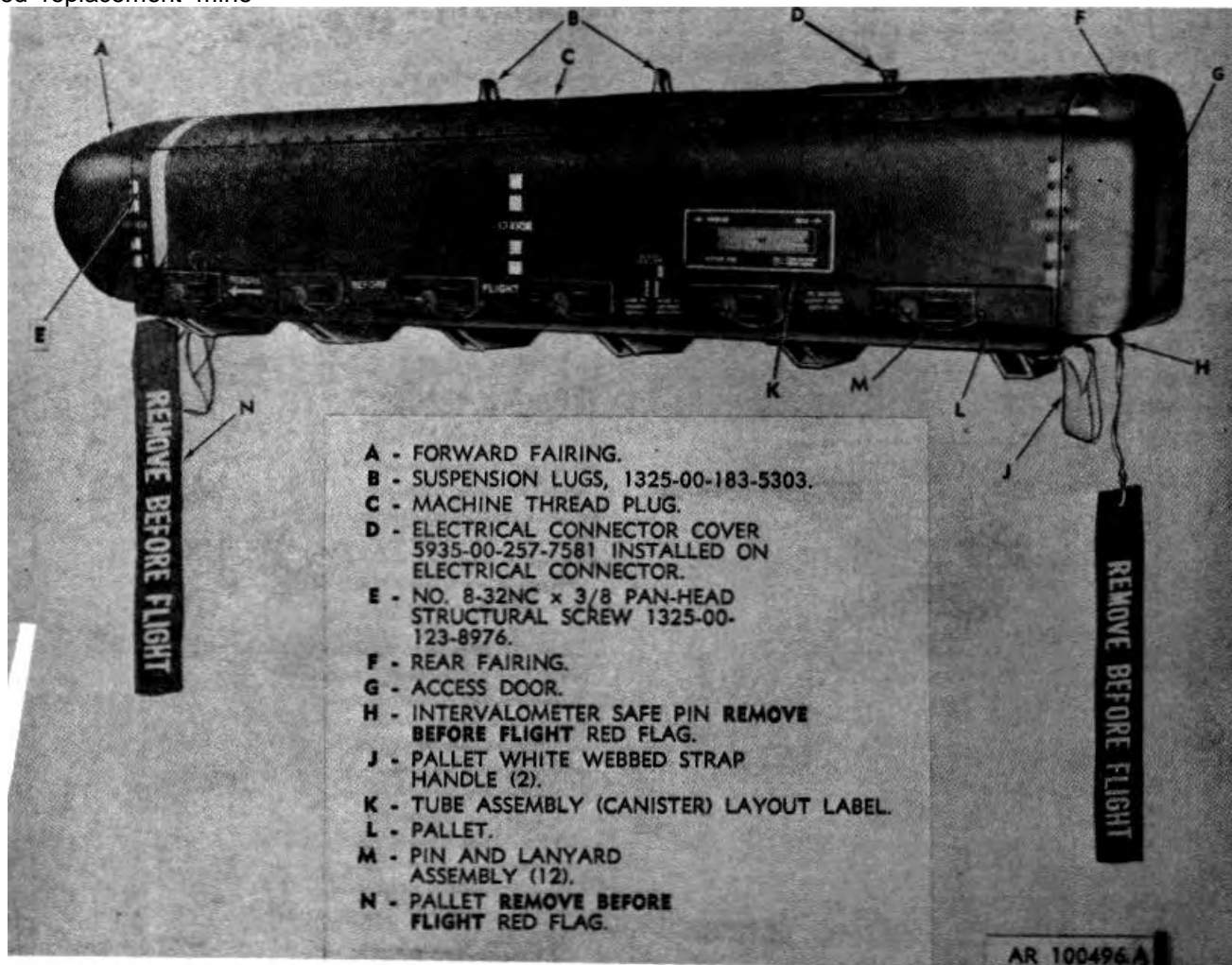

Figure 11-2. Mine dispersing subsystem, aircraft: M56.

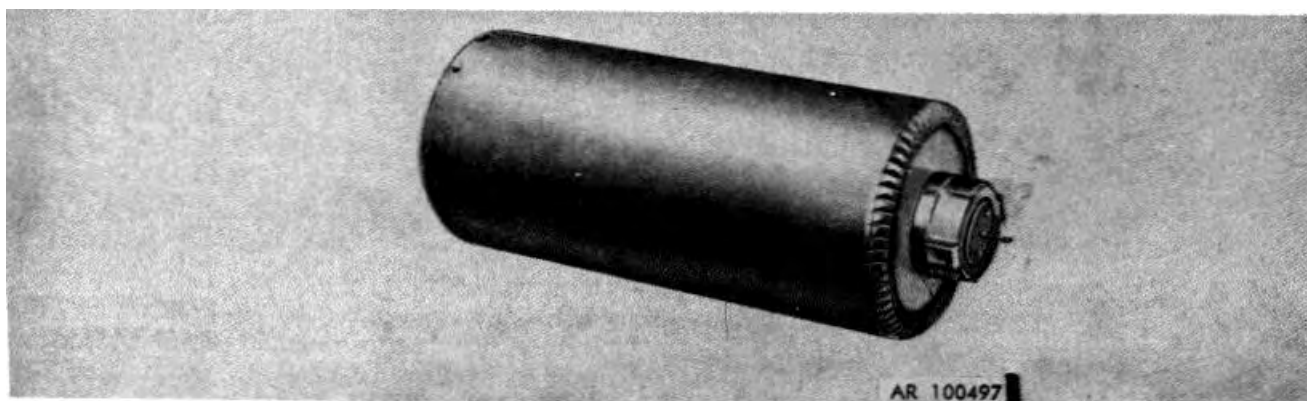

Figure 11-3. Canister assembly.

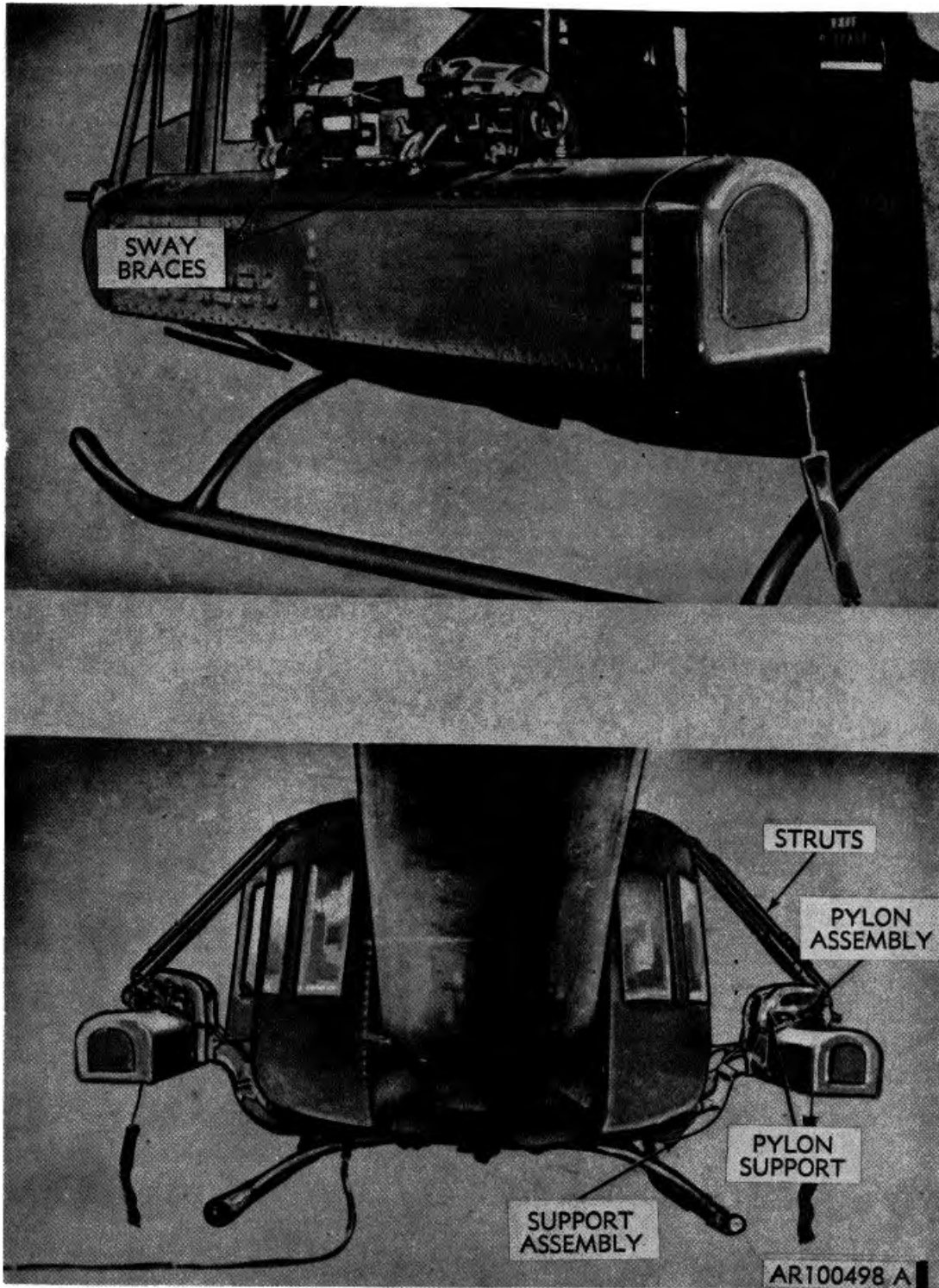

Figure 11-4. Mine dispersing subsystem, aircraft: M56 mounted on UH-1H helicopter (the struts, pylon assembly, pylon support, and support assembly comprise the multi-armament kit).

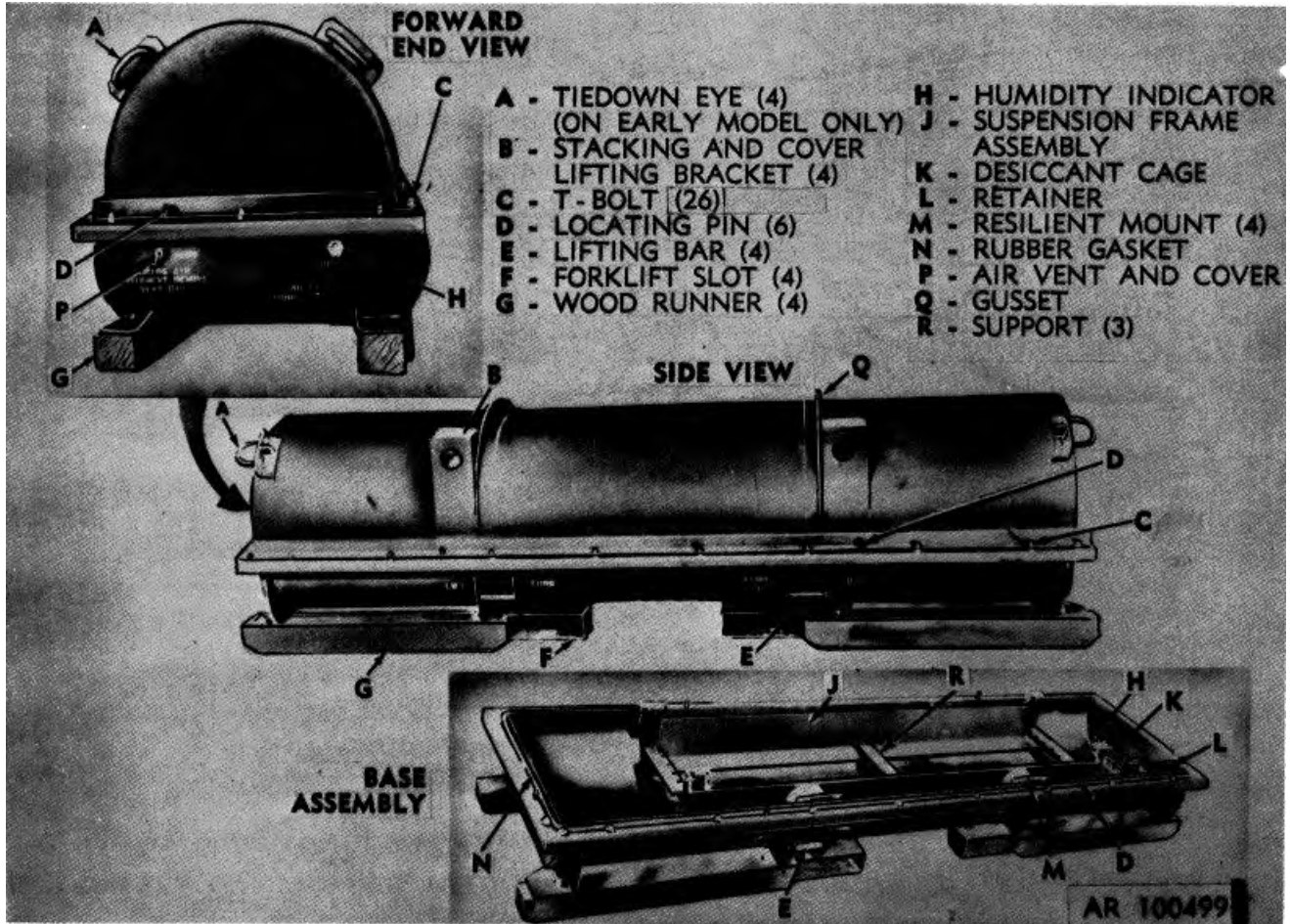

Figure 11-5. Shipping and storage container CNU-79/E.

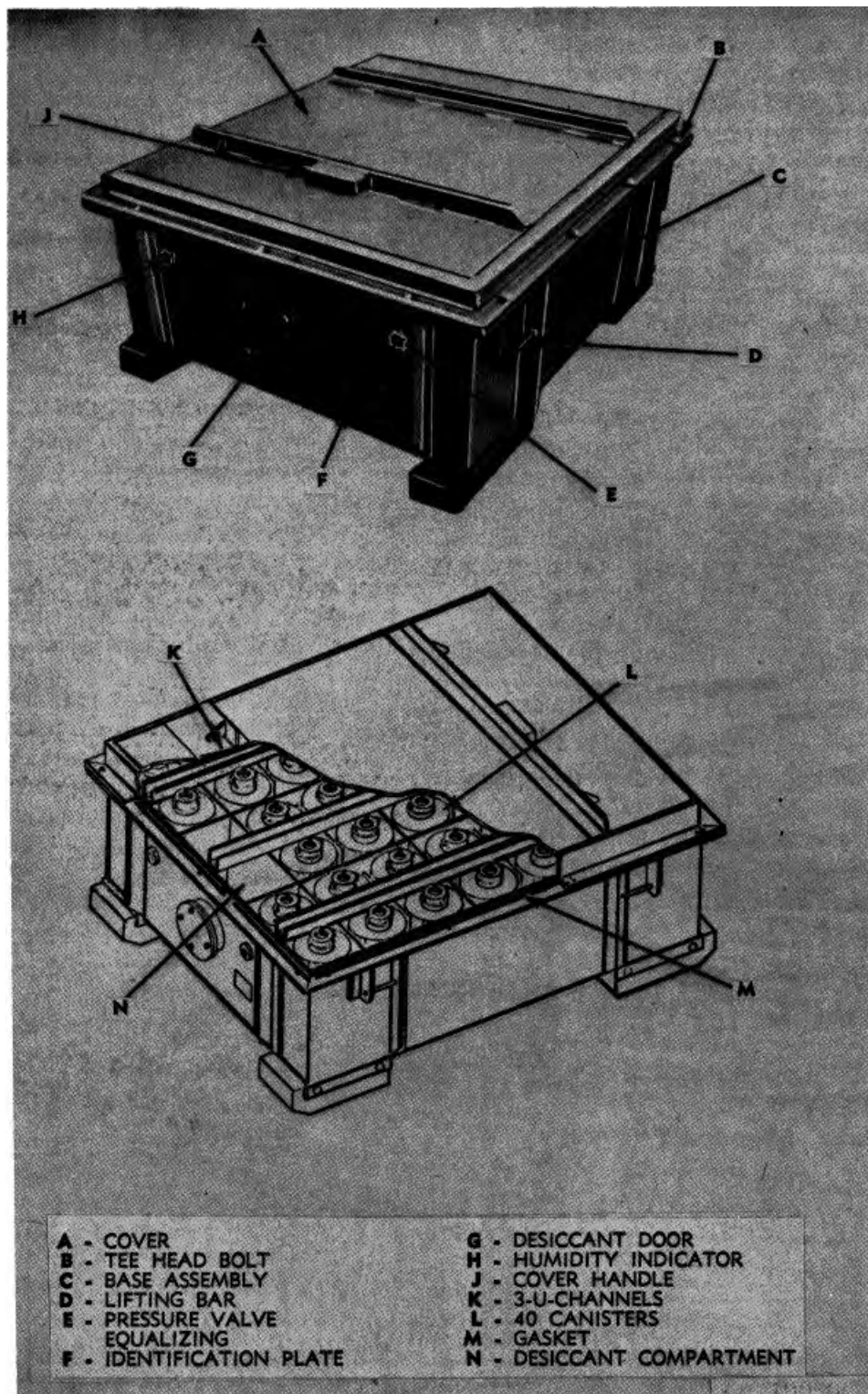

Figure 11-6. Mine canister shipping and storage container M602 (as used in reload kit).

11-4. Practice and Inert Scatterable Mines

a. General.

(1) The Mine Dispensing Subsystem, Aircraft, Practice: M132, which contains inert mines with

live ejection charges, is used by aircraft crews to gain experience in dispersing mines.

(2) The Mine Dispensing Sybsystem, Aircraft, Training: M133, is utilized for training in handling

of the subsystem and contains inert mines with inert ejection charges.

b. Types.

(1) The M132 subsystem consists of a dispenser SUU-13D/A containing three practice canister assemblies. The loaded dispenser is packed in the shipping and storage container CNU-79/E. Each practice canister contains two dummy mines and one ejection charge M198. The reload kit for the M132 subsystem consists of 40 practice canister assemblies. Handling, loading, electrical tests, and repairs of the subsystem are the same as those specified for the service subsystem.

(2) The M133 subsystem consists of one dispenser, bomb SUU-13D/A containing 40 canisters, mines: training (empty) and is packed in the shipping and storage container CNU-79/E and 40 mine canister assemblies packed in the M602 shipping and storage container. The dispenser containing empty canisters is used to simulate a dispenser as returned from a mission. The canisters packed in the M602 container are weighted and configured to simulate the service items. They are used to reload the dispenser, provide the means for conducting the required electrical tests, and serve as the method for gaining "hands-on" experience.

11-5. Description

a. *Mine Dispenser.* The M56 subsystem utilizes a bomb (mine) dispenser, SUU-13D/A (fig. 11-2). This dispenser has a rounded top surface, an aerodynamic nose fairing, and a flat rear fairing.

Two suspension lugs are assembled to the dispenser for attaching to the aircraft or for handling with a sling and hoist. The dispenser contains 40 vertical aluminum canister assemblies, each containing two mines (fig. 11-3).

b. *Canister Assembly.* Each canister assembly consists of an aluminum dispenser cylinder, obturator, mine ejection cartridge M198, and two mines. The mines are retained in the cylinder by four shear pins, two per mine.

c. *Mine Release.* The mine dispenser is designed to provide release of mines from the 40 canisters with application of current through the intervalometer, which is the sequencing component of the dispenser, to the mine ejection charge M198. Release of mines from all 40 canisters is accomplished within a variable time span which is controlled by the helicopter pilot. A quick-release safe pin with an attached REMOVE BEFORE FLIGHT red flag is installed in the intervalometer through an access hole in the bottom of the aft fairing to prevent accidental activation of the intervalometer before flight. The helicopter pilot can control the dispensing intervals from the DISPENSER control panel (fig. 11-7).

d. *Dispenser Pallet.* A removable wood and aluminum pallet, colored red, is attached to the bottom of the dispenser. A REMOVE BEFORE FLIGHT red flag is attached to the forward end. The pallet protects the mines while handling the subsystem and prevents accidental expulsion of mines prior to flight.

11-6 Change 2



Figure 11-7. Mine dispersing subsystem, M56 dispenser (DISP) control panel

e. *Firing.*

(1) The subsystem is fired by depressing the FIRE button of the control panel (fig. 11-7). The firing sequence will continue until the quantity of mines selected have been ejected from the subsystem. After the FIRE button is depressed, the firing sequence may be terminated by resetting the SAFE-STBY-ARM switch to the STBY (standby) position. When the switch is again set in the ARM position and the FIRE button is again depressed, a new firing sequence is initiated.

(2) The electrical impulse from the dispenser control panel and through the intervalometer,

initiates the ejection charge in each canister assembly. Gases from the ejection charge apply an expelling force to the obturator which forces the mines from the canister and the subsystem. As the leave the canister, the bore rider pin in each mine is released, freeing the mechanical component of the mine fuze to start the arming sequence upon impact with the ground. When the mines are free of the canister, the fins open, causing mine separation and orientation of the mine for controlled impact with the ground.

(3) The mine has a self-destruct capability.

11-6. Shipping and Storage Containers.

a. *General.* The dispersing subsystem M56 is stored and transported in the reusable, steel, shipping and storage container CNU-79/E. Forty replacement canisters are stored and shipped in the reusable, steel, shipping and storage container M602. Both containers are stored and transported in the horizontal position.

b. *Container CNU-79/E.* The subsystem is supported by a resilient-mounted suspension frame assembly that is attached to the container base assembly. Two flexible strap assemblies, one at each end, secure the subsystem M56 to the suspension frame assembly. The cover assembly is secured to the base assembly by 26 quick-acting T-bolts. Locating pins are provided to properly align the cover assembly with the base assembly. All openings are provided with gaskets to make the container airtight. A rubber gasket on the base assembly flange makes an airtight seal between the cover and base assemblies. Desiccant is used to absorb excessive moisture within the container. A

desiccant cage, retainer, air vent and cover, and humidity indicator plug are located at the forward end of the container base assembly.

c. *Container, M602.* (As used in Reload Kit.) This reusable steel container is rectangular and is provided with a gasket between the base assembly and the cover to make it airtight. The cover assembly is secured to the base assembly by 14 quick-acting T-bolts. Two cover handles are provided for manual lifting of cover from base assembly. A desiccant door, pressure equalizing valve, and humidity indicator are located at the forward end of the container base assembly.

11-7. Painting and Marking

a. The M56 bomb (mine) dispenser is olive drab with yellow markings. One yellow band located directly behind the forward fairing indicates high explosive loading.

b. The shipping and storage container CNU79/E and M602 (reload kit) are painted olive drab with markings in yellow.

Change 2

CHAPTER 12 GUIDED MISSILES

12-1. General

a. The term, guided missile, refers to a missile directed to its target while in flight or motion, either by a preset or self-reacting device within the missile or by radio command outside the missile, or through wire linkage to the missile.

b. Guided missiles are shipped completely assembled and ready for use, or in major components which must be assembled in the field. In general, a guided missile is composed of the seven basic components illustrated in figure 12-1 and defined below:

(1) *Aerodynamic structure*-The design and fabrication of the missile body.

(2) *Control system*-The pilot component which keeps the missile in a stable flight attitude and makes changes in course direction and altitude in response to signals from the guidance system. The control system operates the control surfaces and the propulsion unit.

(3) *Guidance system*-The source of continuous target intelligence (course data) that guides the missile to its target.

(4) *Propulsion system*-The power supply for the missile.

(5) *Warhead*-The component which carries the payload. The mission of a guided missile is delivery of the warhead with maximum effect on its target.

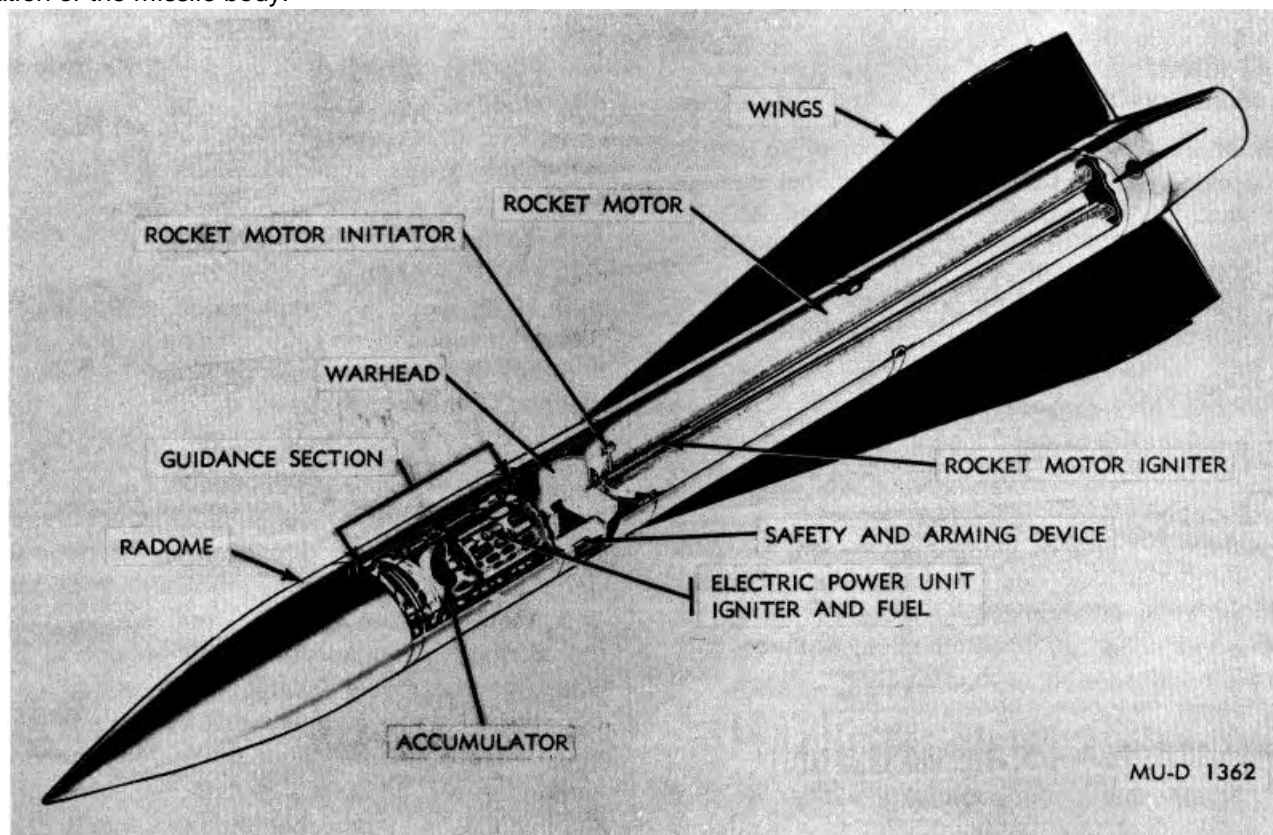

Figure 12-1. Typical guided missile showing location of components.

(6) *Safety and arming device*-The component which causes the warhead to function at the time and under the circumstances desired.

(7) *Electrical power system*-The source of electricity for operation of guidance, control, and safety and arming systems.

12-2. Classification

a. General. Guided missiles are classified according to origin of missile launch, destination and mission. They are designated by model number and modification letter, popular name and other designations.

b. Basic Designations Based on Origin and Destination.

- AAM-Air-to-air-missile
- ASM -Air-to-surface missile
- AUM-Air-to-underwater missile
- SAM -Surface-to-air missile
- SSM -Surface-to-surface missile
- SUM-Surface-to-underwater missile
- UAM-Underwater-to-air missile
- USM -Underwater-to-surface missile
- UUM-Underwater-to-underwater missile

c. Basic Designations Based on Missile Mission.

- High explosive
- Antiaircraft
- Antimissile
- High Explosive Antitank

d. *Model Number and Modification Number*. Each basic designation contains a model number and modification number (e.g., Guided Missile, Antiaircraft XM50E1).

e. *Popular Names*. Names, such as Hawk, Nike, Falco and Sidewinder, may be assigned to guided missiles.

12-3. Identification

Guided missiles and their components are identified by painting and marking. Marking includes such data as name of component, model designation, lot number and manufacturer, date of manufacture, type of warhead and the like. Conventional warheads are painted in accordance with the color coding table in chapter 1.

12-4. Aerodynamic Structure

a. The aerodynamic structure, which includes the entire external surface of the missile, determines flow characteristics of the missile through air or water. This structure also serves to package

missile components and provide the necessary superstructure for assembly of the missile. It can be constructed from steel or aluminum alloys, depending on strength of weight characteristics desired.

b. The aerodynamic structure is designed to give least resistance to flight of the missile. The radome or missile nose cover, and the wing or fin structure, the most important components, are usually streamlined and swept to provide stabilization with minimum resistance at supersonic speeds.

12-5. Control and Guidance Systems

a. *General*. Control and guidance are parts of an integrated system for automatically directing flight of the missile.

b. *Control System*. The control system includes components necessary for automatic control of a missile in flight. The system receives intelligence from a radio signal or other electrical device (wire or wireless) and makes corrections for changes in yaw, pitch and roll. The system usually includes a gyroscope, signal amplifier, servomotor and control surface. The system may also receive internal or external guidance signals in order to adjust the path of a missile.

(1) The *gyroscope* is used to fix a reference direction.

(2) The *amplifier* increases signal strength to a sufficient level to control the servomotor.

(3) The *servomotor* powers the control surfaces to change the flight path of a missile.

(4) The *control surface* changes the missile path by application of some force in response to a directing signal. This change in path (steering) is accomplished by one or more of the following devices: air vanes, jet vanes, movable jet motor or side jets.

c. *Guidance System*. The main functions performed by the guidance system are tracking, computing and directing. Tracking is the process of determining location of a missile and its target with respect to the launcher, and locating missile and target with respect to each other and some other reference. Computing is the process of calculating directing signals for the missile by use of tracking information. Directing is the process of sending the computed signal to the missile. Directing may also be accomplished from within a missile. The directing signals are sent to the control system, thus giving control of missile flight.

Some basic guidance systems are described in (1) through (8) below.

(1) A *preset guidance system*, set into the missile before launching, is one which employs a predetermined ballistic path, and cannot be adjusted after launching.

(2) A *terrestrial reference guidance system* employs a predetermined path which can be adjusted after launching. Adjustment is accomplished by devices within the missile that react to some phenomena of the earth.

(3) A *radio navigation guidance system* employs a predetermined path which can be adjusted. Adjustment is accomplished by devices within the missile that are controlled by external radio signals.

(4) A *celestial navigation guidance system* has a predetermined path which can be adjusted by use of continuous celestial observation.

(5) An *inertial guidance system* employs a predetermined path which can be adjusted after launching by devices within the missile.

(6) A *command guidance system* is one which permits the path of the missile to be changed after launching. Change is accomplished by directing signals from some device outside the missile.

(7) A *beam climber guidance system* is one in which direction of the missile can be changed after launching. Change is accomplished by a device in the missile that keeps it in a beam of energy.

(8) A *homing guidance system* provides for changing direction of the missile after launching. Change is accomplished by a device in the missile that reacts to some distinguishing characteristic of the target.

12-6. Propulsion System

a. General. The propulsion systems used in guided missiles employ either a jet engine or a rocket motor. These systems consist essentially of a combustion chamber and a nozzle. Fuel burned in the combustion chamber produces thrust. This results from products of combustion which expand and pass through the nozzle.

b. Operation. The missile propulsion system generally operates in two phases: the boost phase, during which the missile is accelerated to its cruising speed; and the sustainer phase, which maintains missile velocity and acceleration at the cruising level. In other cases, the missile propulsion system does not require a booster unit and operates only in one phase.

c. Jet Engine. A jet engine may be one of the following types: pulse jet, ram jet or turbo jet. These engines use liquid fuel and atmospheric oxygen as the oxidizer. They are classified as air breathing engines.

d. Rocket Motors. Rocket motors are non-air-breathing propulsion systems, which use solid propellant (fuel and oxidizer combined) or liquid fuel with an oxidizer. (Fuels and propellants for jet engines and rocket motors are covered in chapter 2.)

12-7. Warheads The payload of a guided missile varies with the target and the effect desired. Consequently, the warheads, which carry the payload, are classified according to their function and the effect they create, as indicated below:

a. High Explosive-Destroys target by blast.

b. High-Explosive Fragmentation (fig. 12-2) Projects warhead fragments at high velocity.

Blast at the point of functioning causes additional damage to the target and nearby objects.

c. High-Explosive Antitank-Employs shaped charge effect to penetrate steel armor.

d. Chemical-Releases toxic chemical agents to produce casualties.

e. Atomic-Produces casualties by thermal radiation, blast and nuclear radiation; causes destruction and damage to structures and equipment, and/or denies use of an area because of residual radioactive effects.

f. Practice-Simulates service warheads for training in handling, fuzing, loading and firing.

12-8. Safety and Arming Devices (Fuzes)

a. General.

(1) The fuzing systems used in guided missile warheads are called safety and arming devices. They arm the system at the required distance and function the warhead at the time and under the circumstances desired.

(2) One or more safety and arming devices may be used in conjunction with any of the warheads described in paragraph 12-7. Depending on the type of target and the effect desired, the safety and arming device may be impact, proximity, ground-controlled, or a combination of two or three of these types. Figure 123 shows a typical safety and arming device.

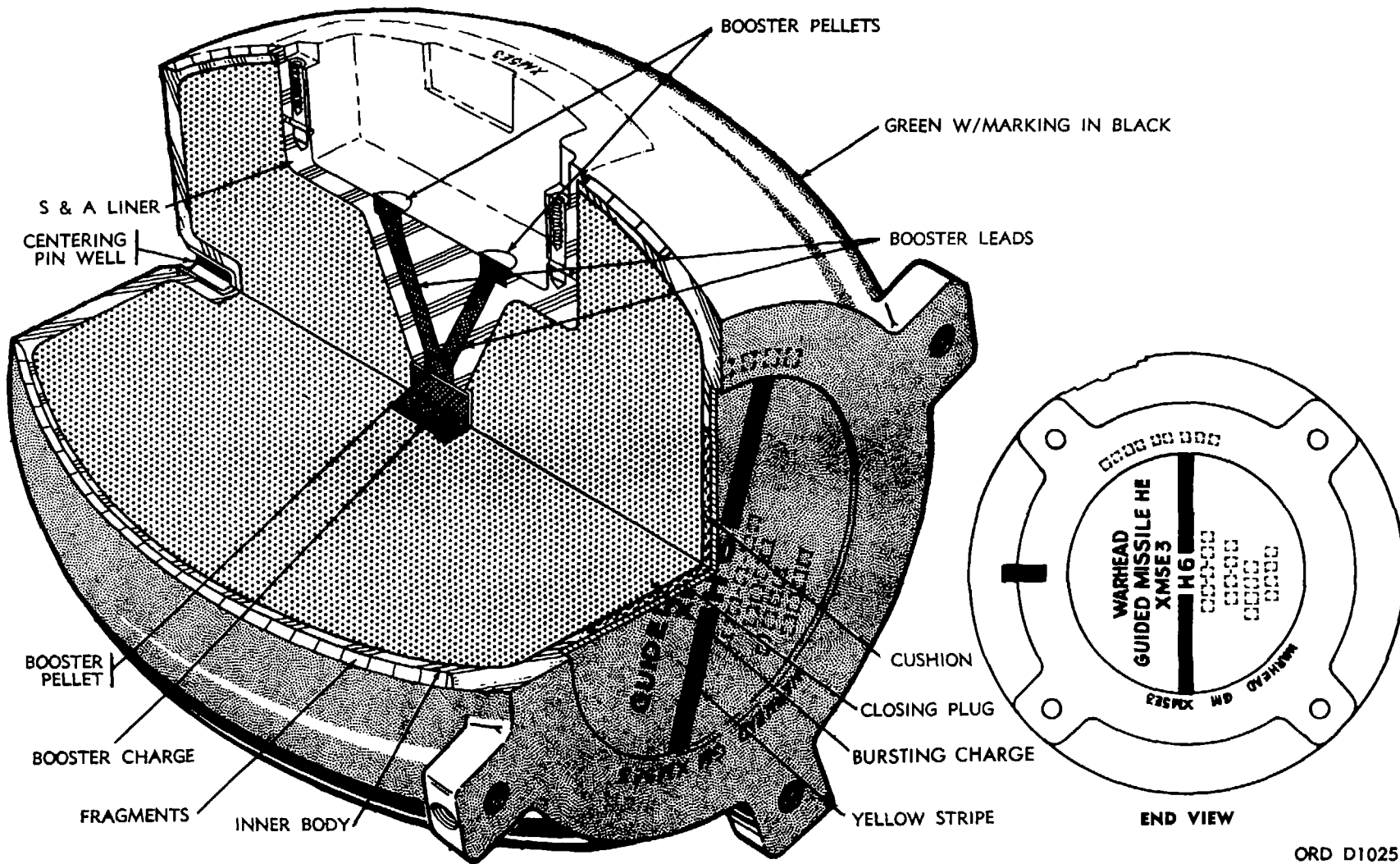

Figure 12-2. High-explosive fragmentation warhead.

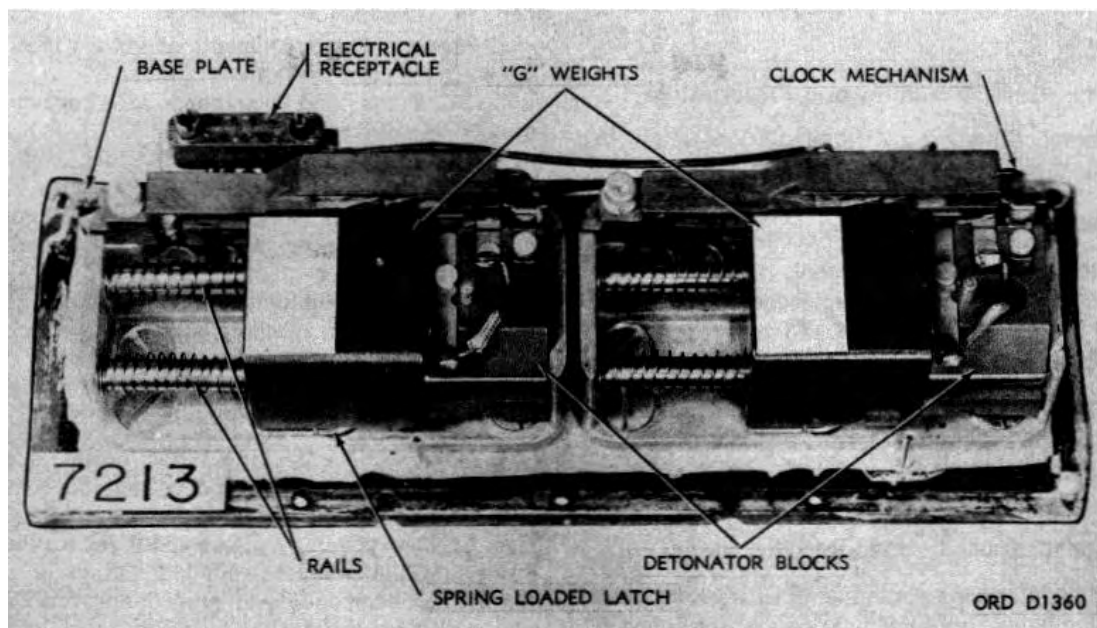

Figure 12-3. Safety and arming device.

b. Types.

(1) *Impact.* An impact safety and arming device is actuated by striking the target. Functioning time after impact depends upon design of the device and nature of the target.

(2) *Proximity.* Proximity safety and arming devices function on approach to a target. Each type of proximity device is actuated by some characteristic of, and at a predetermined distance from, the target. The five basic types are

- (a) Radio
- (b) Pressure
- (c) Electrostatic
- (d) Photoelectric
- (e) Acoustic

(3) *Ground-controlled.* In ground-controlled safety and arming devices, the mechanism for determining target proximity is on the ground instead of in the device. When the proper proximity relationship is reached between the missile and the target, a signal to detonate is sent to the missile.

12-9. Electrical Power System

This system supplies electrical power for operation of the guidance and control mechanism and for fuzing of the warhead. There are two different types of electrical power systems:

a. Battery supply, with or without electronic rectifier and transformer circuit. This type is suitable for small, short range missiles.

b. An alternating-current generator, using a turbine driven by wind, battery, engine or compressed air. This type is suitable for long-range missiles.

12-10. Launchers

a. *General.* Launchers are mechanical structures that provide support and control during initial stages of motion. Launchers enable the missile's control, guidance, and propulsion systems to function effectively.

b. *Types of Launchers.* Some basic types of launching devices are trainable platform, vertical tower, vertical ramp, ramp or rail (other than vertical), zero length (a launcher on which there is negligible travel by the missile), gun, catapult and aircraft.

c. *Firing.* Firing of guided missiles from a launcher is usually accomplished electrically by remote control.

d. *Blast Protection.* Because of the dangerous blast of flame emitted by guided missiles, the launching site must be cleared of personnel and unnecessary equipment. Unprotected combustible material must also be removed from the launching area.

12-11. Care, Handling and Preservation In general, the same safety regulations apply to guided missiles as to other types of ammunition. However, certain components of the missile require special handling.

a. Protect control equipment, which includes such sensitive items as gyroscopes, homing devices, electronic equipment, and other precision instruments, from rough or careless handling.

b. Take special precautions with certain fuels and oxidizers, because of fire, explosion, contact and inhalation hazards.

c. Use protective clothing and masks when handling certain fuels and oxidizers.

d. Carefully train personnel in safety measures, procedures for handling, and precautions in use of guided missile explosive or flammable components.

12-12. Packing and Marking

a. *Packing.* The components of guided missiles are packed in appropriate containers.

(1) Fuzes and warheads are packed in wooden or metal containers.

(2) Propellants, which include fuel, oxidizer, reducer and solid and liquid propellants, are packed in specially designed tanks, metal drums, glass bottles or fiber containers overpacked in wooden boxes.

(3) Control equipment and guidance equipment are packed in specially constructed packings designed to protect the precision instruments.

(4) Propulsion systems are packed in metal crates or wooden boxes, crates and containers.

b. *Marking.* The packing boxes, crates, drums and containers in which guided missile components are packed are marked for easy identification. They may or may not be coded for a specific guided missile complete round. Packings of propellant and components of propellants, fuzes and warheads are also marked to indicate the Department of Transportation shipping name and important instructions in handling or storage.

CHAPTER 13

PROPELLANT ACTUATED DEVICES

13-1. General

a. Propellant actuated devices (PAD) are designed to do a specific task by use of the energy in propellant gases. The propellant may be contained in a replaceable cartridge or permanently sealed into the device. The basic design for most devices consists of a piston and cylinder combination.

Hot, propellant gas is used to cause the piston to extend or retract. There are many variations of this basic design: those in which the piston is allowed to separate from the cylinder; some in which the piston remains sealed through the full stroke; and others in which the velocity and thrust of the piston are controlled by means of a built-in damper.

b. For a detailed technical discussion of propellant actuated devices, see TB 9-1377-200; for maintenance information, see the maintenance manual for the system in which the item is installed. Propellant actuated devices, specialized repair parts, and cartridges for the devices are listed in SC 1340/98IL.

13-2. Identification

Nomenclature is marked on the item and on the outer packing. The packing box is also marked with the Federal Stock Number and lot number, if the item is Government developed. Commercially developed items may show only the commercial nomenclature and part number.

13-3. Explosive Embedment Anchor

a. *General.* The explosive embedment anchor (fig. 13-1) is currently used to secure underwater pipelines. Two anchors, each bearing a cartridge containing 3 1/2 pounds of propellant, are mounted on the pipeline sled. Anchors are fired after the end of the pipeline has been pulled into its final position. This item has other possible underwater applications.

b. *Ignition Method.* Ignition is by electric current. Prior to launching, a firing wire is connected to the

ignitor contacts in a way that facilitates simultaneous firing of both anchors.

c. *Cartridge.* The cartridge (para 13-6) is not a stock item. It is furnished with the explosive anchor, unassembled. Ordnance personnel assemble cartridges and anchors on site.

13-4. Cutters

a. *General.* Cutters are used to sever one or more textile or metal cable (e.g., parachute reefing line or rescue hoist cable).

b. *Ignition Methods.* Ignition is either by a spring-loaded firing pin striking a percussion primer or by electric current passing through an electrical primer. A mechanically fired cutter is shown in figure 13-2. An electrically fired cutter is shown in figure 13-3.

c. *Delay Feature.* Reefing line cutters are made in delay times ranging from one to twenty seconds. The cutter is so rigged in the parachute that the firing pin strikes the primer when the suspension lines are extended. A built-in pyrotechnic delay element burns for a specified period of time and then ignites the main propellant charge. This energy moves a cutter blade to sever line or cable.

13-5. Parachute Ejector

a. *General.* Parachute ejectors forcibly remove a personnel reserve parachute from its pack. Figure 13-4 shows a representative ejector, which contains two cartridges. Another type contains only one cartridge. In basic makeup, the ejector is a long, slender piston-cylinder assembly. Gas pressure is supplied by one or two cartridges contained in chambers called initiators. When the ejector is fired, the piston remains in the cylinder. The whole device remains gas tight.

b. *Ignition Method.* Ignition is by a springloaded firing pin striking a percussion primer in the cartridge. The firing pin is both cocked and released when the firing pin ring is pulled.

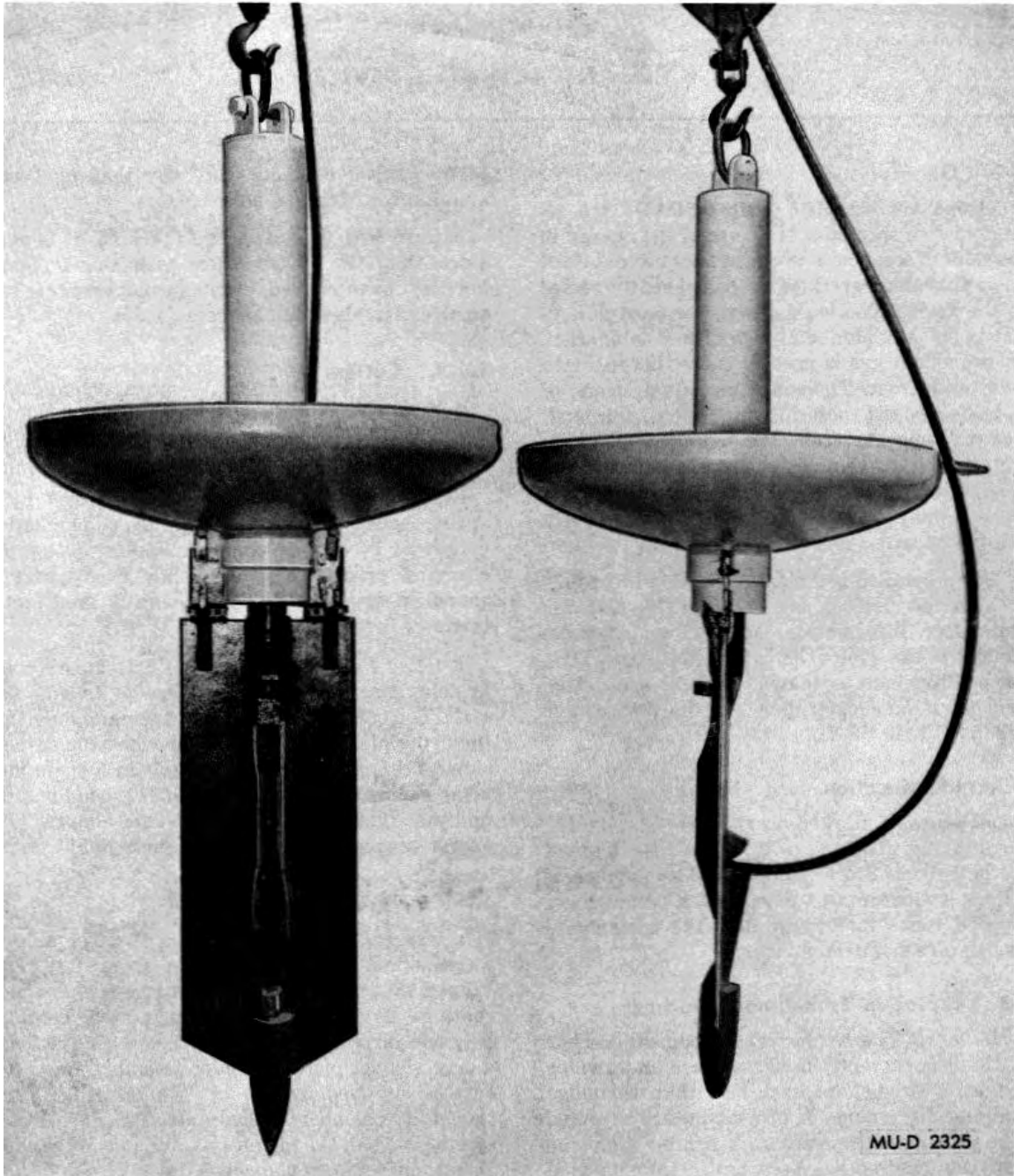

Figure 13-1. Explosive embedment anchor.

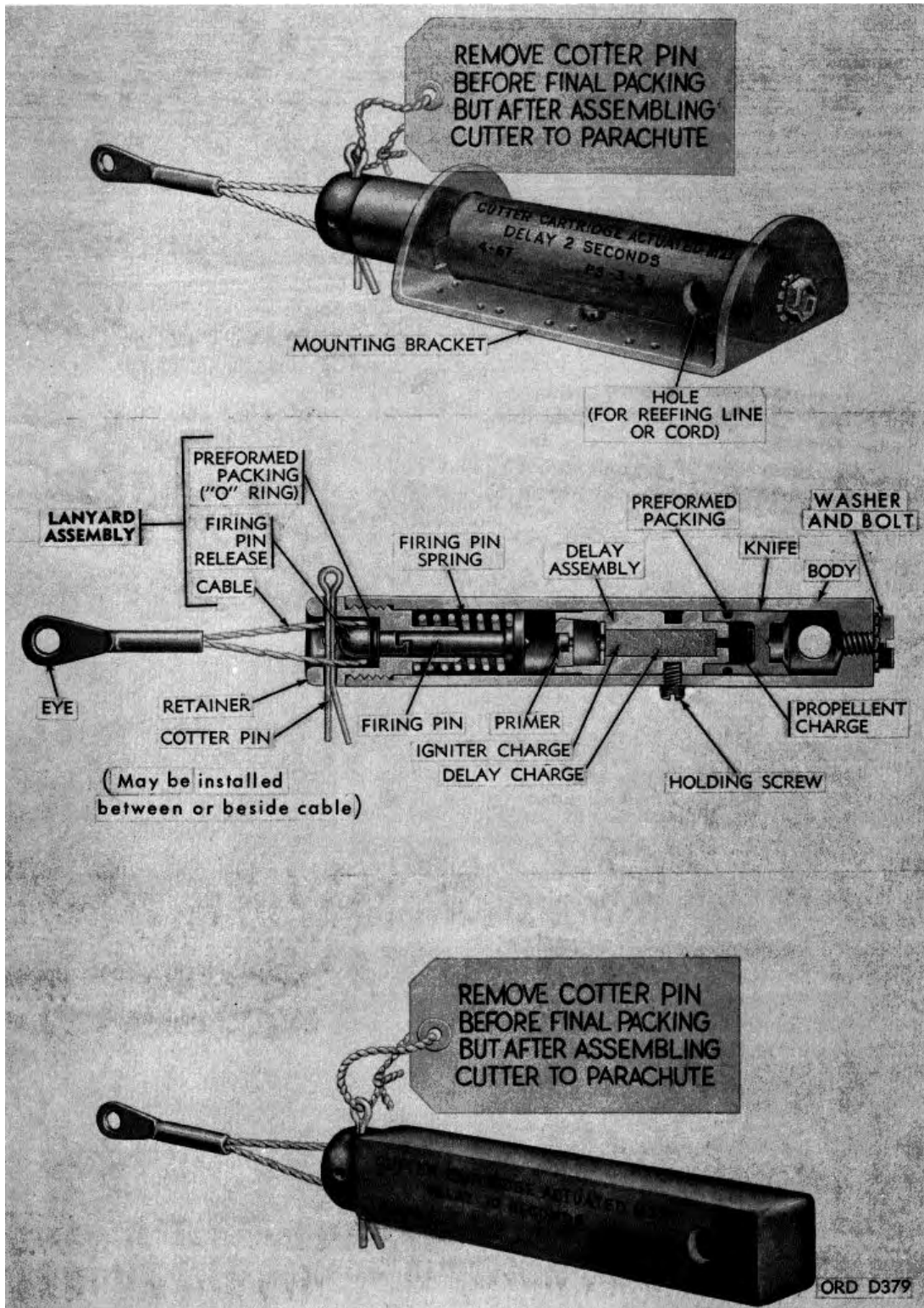

Figure 13-2. Mechanically fired cutter.

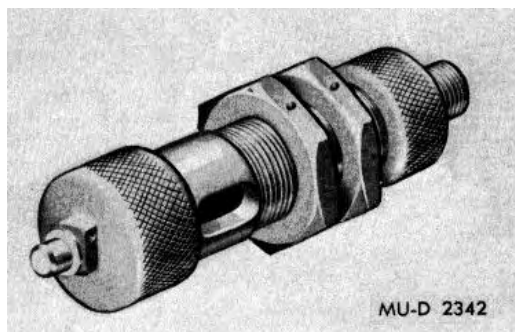

Figure 13-3. Electrically fired cutter.

c. Safety Pin. Ejectors are packed with a safety pin installed to prevent accidental firing by a pull on the firing pin ring. This pin must remain installed until after the ejector is packed into a chute. It must be reinstalled on removal of the ejector from the parachute.

13-6. Cartridges

a. General.

(1) Replaceable cartridges are used in aircraft stores ejectors (fig. 13-5), parachute cargo releases, aircraft fire extinguishers (fig. 13-6), parachute drogue guns, and cable cutters (fig. 3-7).

(2) Cartridges are also used in reefing line cutters (aircraft seat catapults), and parachute ejectors. In these applications, however, the cartridges are handled only at depot level.

(3) The size and form of cartridges vary broadly. Differences depend on the amount of propellant required, method of firing, and mounting arrangement.

(4) Commercial cartridges are identified by a variety of names, depending on the internal design and intended use. Some examples of commercial names follow: squib, dual squib, initiator, cutter cartridge, fire extinguisher cartridge, primary cartridge, secondary cartridge, and explosive cartridge.

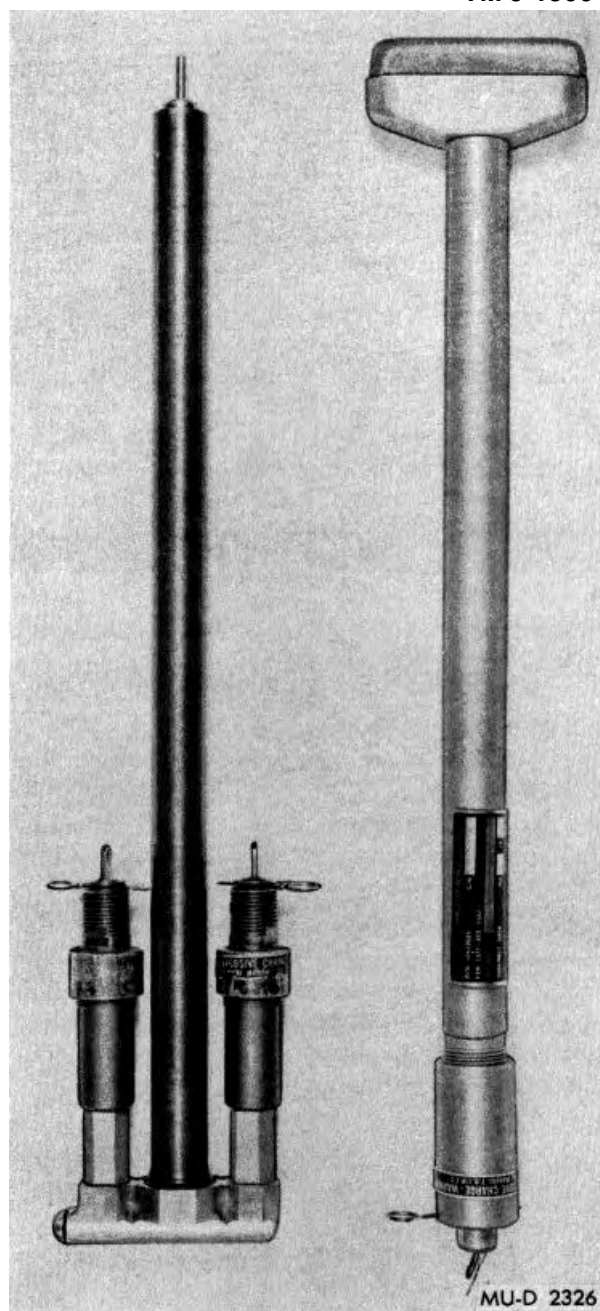

Figure 13-4. Parachute ejector.

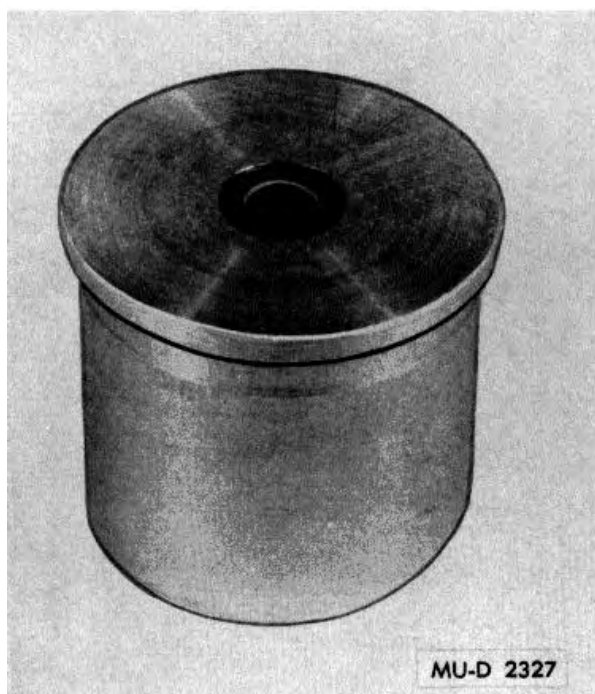

Figure 13-5. Stores ejector cartridge.

(5) Some of these devices are included in Federal Stock Class 1377, while others carry the class of the equipment with which they are associated. For example, an aircraft stores ejector may be classed as an air frame structure, but the cartridge is classed as a propellant actuated device.

b. Types. All cartridges are divided into two general categories: impulse cartridges and delay cartridges. Both types are actually impulse generating devices but the word, delay, indicates that ignition takes place some time after the primer is set off.

(1) Delay cartridges are designed with specific delay times for specific purposes. Delay times range from less than a second to about 20 seconds. Manufacturing tolerances allow a variation in actual delay times of about 20 percent. For example, a delay cartridge labeled as a 1-second delay will have an actual delay time ranging between 0.8 second and 1.2 seconds.

(2) An impulse cartridge will fire almost instantaneously with activation of the primer.

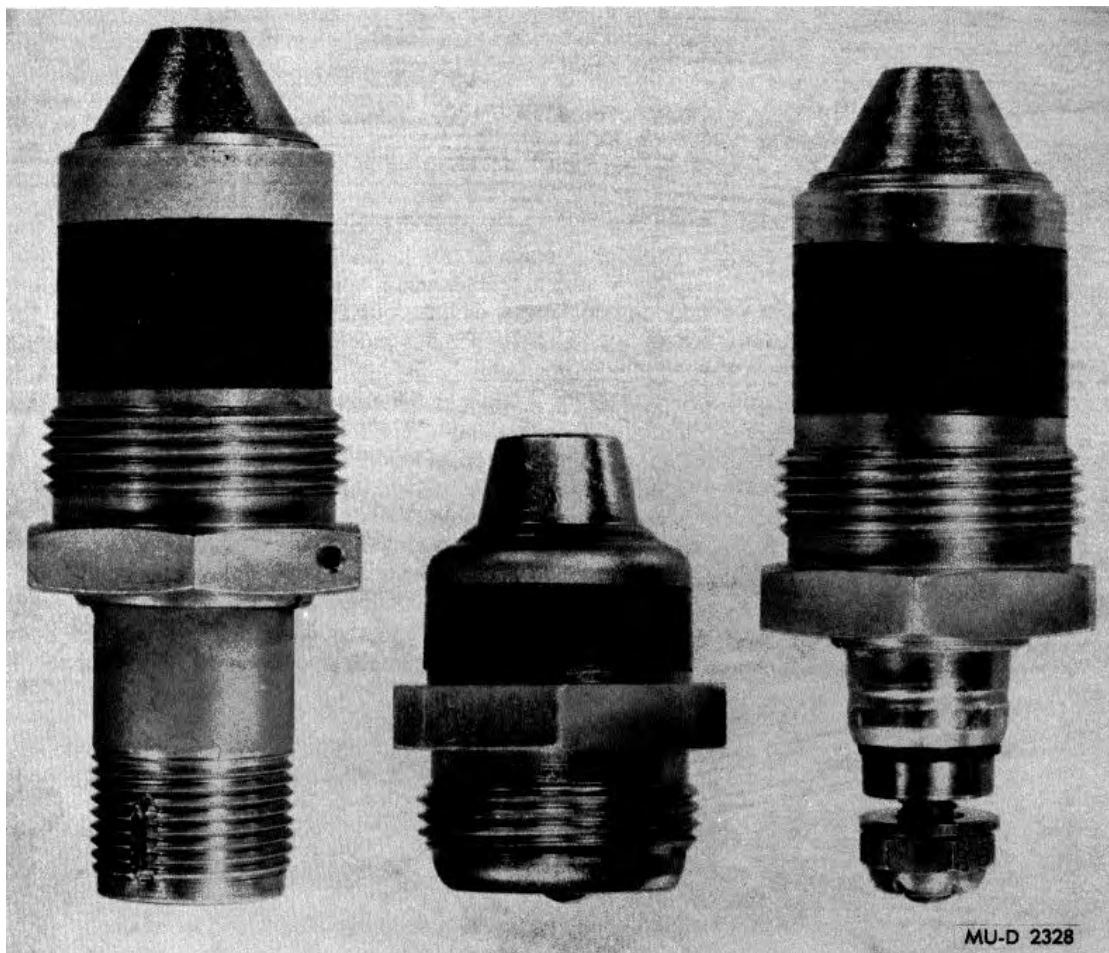

Figure 13-6 Fire extinguisher cartridges.

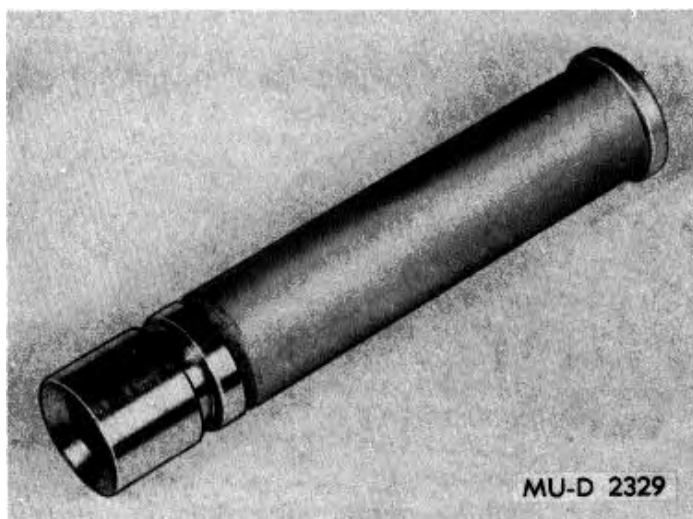

Figure 13-7. Cable cutter cartridges.

c. Priming Methods.

(1) *Percussion.* Some cartridges are fired by mechanical means. In this case, the primer is a percussion primer, which must be struck to fire. A familiar example of use of a percussion primer is in ammunition for the service rifle.

(2) *Electrical.* Some cartridges are fired by passing electrical current through the primer. In this case, the primer is heat sensitive rather than percussion sensitive.

d. Applications. Removable and replaceable cartridges are used in stores ejectors (fig. 13-5), extinguishers (fig. 13-6), cutters (fig. 13-7), aircraft seat catapults (fig. 13-8), training catapults (fig. 13-9), cargo parachute releases (fig. 13-10), towline rockets and power tools.

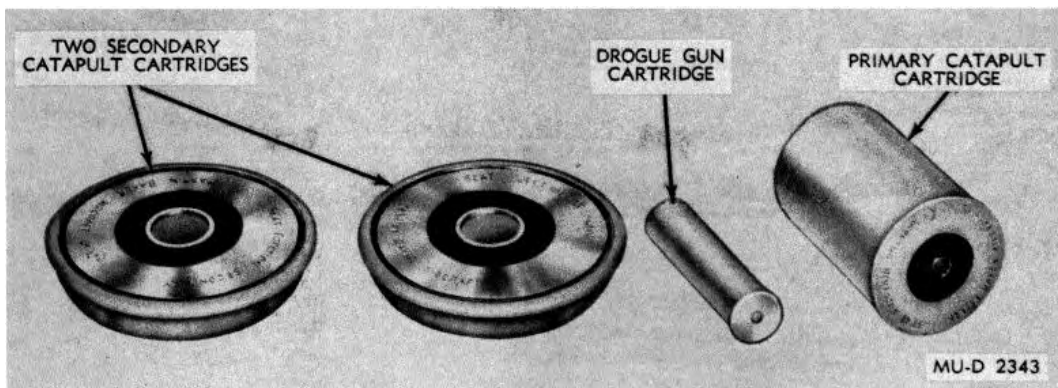

Figure 13-8. Escape cartridge set.

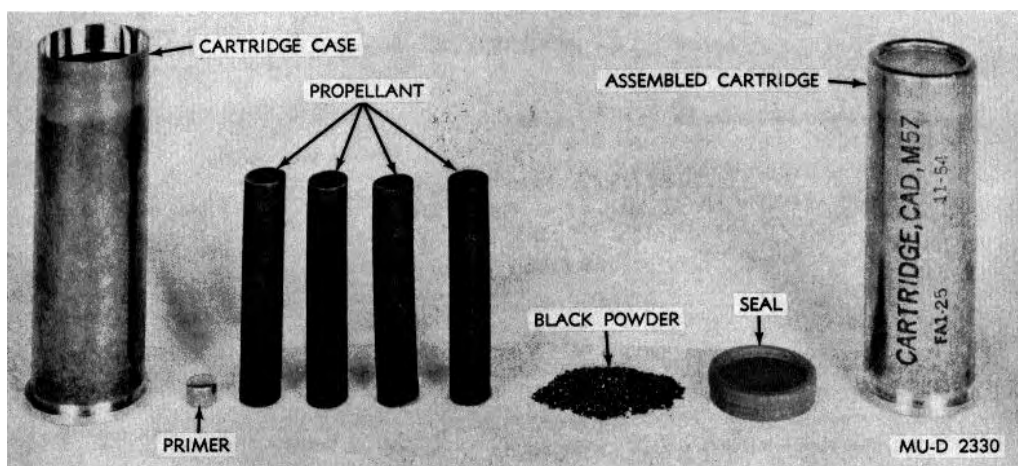

Figure 13-9. Training catapult cartridge.

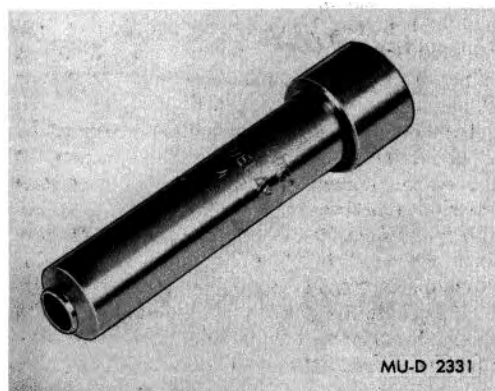

Figure 13-10. Parachute release delay cartridge.

13-7. Care and Precautions in Handling

- a. Handle all types of cartridges with care at all times. Have installation and removal of cartridges performed only by trained personnel. When not installed, store cartridges in shipping containers.
- b. Short terminals of electrically fired cartridges by means of specifically designed cap, or by wrapping in metal foil. This prevents accidental firing, should terminals come in contact with electrical power.
- c. Observe recommendations for care, handling and preservation of ammunition given in chapter 1—they apply generally to all types of propellant actuated devices.

APPENDIX A

REFERENCES

A-1. Administrative Publications

a. Army Regulations.

Transportation by Water of Hazardous Cargo	AR 55-228
Defense Traffic Management Regulation	AR 55-355
Malfunctions Involving Ammunition and Explosives	AR 75-1
Responsibilities and Procedures for Explosive Ordnance Disposal	AR 75-15
Dictionary of United States Army Terms	AR 310-25
Authorized Abbreviations and Brevity Codes	AR 310-50
Department of the Army Information Security Program	AR 380-5
Laser Guidance System Security Classification Guide	AR 380-6
Policy for Safeguarding and Controlling Communications	
Security (COMSEC) Material	AR 380-40
Army Safety Program	AR 385-10
Use of Explosives and Pyrotechnics in Public Demonstrations,	
Exhibitions, and Celebrations	AR 385-26
Safety Color Code Markings and Signs	AR 385-30
Accident Reporting and Records	AR 385-40
Coordination with Department of Defense Explosive Safety Board	AR 385-60
Policies and Procedures for Firing Ammunition for Training,	
Target Practice, and Combat	AR 385-63
Identification of Inert Ammunition and Ammunition Components	AR 385-65
Fire Protection	AR 420-90
Ammunition Peculiar Equipment Program (APE)	AR 700-20
Defense Standardization and Specification Program	AR 700-47
Requisitioning, Receipt, and Issue Items	AR 725-50
Reporting of Item and Packaging Discrepancies	AR 735-11-2

b. DA Pamphlets.

Consolidated Index of Army Publications and Blank Forms	DA Pam 25-30
Index of Graphic Training Aids (GTA)	DA Pam 25-37
The Army Maintenance Management System (TAMMS)	DA Pam 738-750

A-2. Blank Forms

Discrepancy of Shipment Report	SF 361
Report of Discrepancy	SF 364
Packaging and Improvement Report	DA Form 6
Accident Report	DA Form 285
Request of Issue and Turn-in of Ammunition	DA Form 581
Munition Surveillance Report - Descriptive Data of Ammunition	
Represented By Sample	DA Form 984
Recommended Changes to Publications and Blank Forms	DA Form 2028
Ammunition Condition Report	DA Form 2415
Ammunition Stores Slip	DA Form 3151-R
Ammunition Data Card	DD Form 1650
Fire Incident Report	DD Form 2324
Fire Emergency Report	DD Form 2324-1

A-3. Doctrinal, Training, and Organizational Publications

Chemical Reference Handbook	FM 3-7
Flame Fuels	FM 3-11
Explosives and Demolitions	FM 5-250
Camouflage, Basic Principles and Field Camouflage	FM 20-3
Mine/Countermine Operations	FM 20-32
Grenades and Pyrotechnic Symbols	FM 23-30
Military Training Management	FM 25-2
Operational Terms and Symbols	FM 101-5-1
Field Artillery, Manual Cannon Gunnery	TC 6-40

A-4. Equipment Manuals

a. Technical Manuals.

Storage, Shipment, Handling, and Disposal of Chemical Agents and Hazardous Chemicals	TM 3-250
Data Sheets for Ordnance Type Materiel	TM 9-500
Ammunition and Explosives Standards	TM 9-1300-206
Military Explosives	TM 9-1300-214
Organizational Maintenance Manual (Including Repair Parts and Special Tools List) for Small Arms Ammunition to 30MM inclusive (FSC 1305)	TM 9-1305-201-20&P
Direct Support and General Support Maintenance Manual (Including Repair Parts and Special Tools List) for Small Arms Ammunition to 30MM inclusive (FSC 1305)	TM 9-1305-201-34&P
Operator's and Unit Maintenance Manual for Grenades	TM 9-1330-200-12
Direct Support and General Support Maintenance Manual for Grenades	TM 9-1330-200-34
Operator's and Organizational Maintenance Manual for Mine Dispersing Subsystem, Aircraft: M56 and Mine Dispersing Subsystem, Aircraft, Practice: M132	TM 9-1345-201-12
Direct Support Maintenance Manual (Including Repair Parts and Special Tools List) for Mine Dispersing Subsystem, Aircraft: M56	TM 9-1345-201-30&P
Operator's and Unit Maintenance Manual (Including Repair Parts and Special Tools List) for Land Mines	TM 9-1345-203-12&P
Organizational Maintenance Manual (Including Repair Parts and Special Tools List) for Military Pyrotechnics	TM 9-1370-203-20&P
Operator's and Unit Maintenance Manual (Including Repair Parts and Special Tools List) Demolition Materials	TM 9-1375-213-12
Direct Support and General Support Maintenance Manual (Including Repair Parts and Special Tools List) Demolition Materials	TM 9-1375-213-34
Army Ammunition Data Sheets for Small Caliber Ammunition (FSC 1305)	TM 43-0001-27
Army Ammunition Data Sheets for Artillery Ammunition: Guns, Howitzers, Mortars, Recoilless Rifles, Grenade Launchers, and Artillery Fuzes (FSC 1310, 1315, 1320, 1390)	TM 43-0001-28
Army Ammunition Data Sheets for Grenades	TM 43-0001-29
Army Ammunition Data Sheets for Land Mines (FSC 1345)	TM 43-0001-36
Army Ammunition Data Sheets for Demolition Materials	TM 43-0001-38
Storage and Materials Handling	TM 743-200-1
Destruction of Conventional Ammunition and Improved Conventional Munitions to Prevent Enemy Use (Excluding Toxic and Incapacitating Chemical Agents) (For Combat Use)	TM 750-244-5-1

b. Technical Bulletins.

Department of Defense Explosives Hazard Classification Procedures	TB 700-2
Munitions, Restricted or Suspended	TB 9-1300-385
Propellant Actuated Devices	TB 9-1377-200
Army Nuclear Weapon Equipment Records and Reporting Procedures	TB 9-1100-803-15

c. Supply Bulletins.

Army Adopted/Other Items Selected For Authorization/List of Reportable Items	SB 700-20
Federal Supply Classification: Part 1, Groups and Classes.....	SB 708-21
Department of Defense Ammunition Code (Cataloging Handbook H3)	SB 708-3
Ammunition Packing Material and Certain Specified Ammunition Components	SB 755-1

A-5. Supply Catalogs

FSC Group 13 Ammunition and Explosives (Classes 1305-1330)	SC 1305/30-IL
FSC Group 13 Ammunition and Explosives (Classes 1340-1398)	SC 1340/98-IL

THIS PAGE INTENTIONALLY LEFT BLANK

Change 5 A-4

INDEX

	Paragraph	Page
Accidents, reports.....	1-2b	1-1
Adamsite (DM).....	2-24f	2-21
Aerial Mines:		
General.....	11-1	11-1
Tactical fighter dispenser systems:	11-8	11-7
Description	11-9	11-7
General	11-8	11-7
Operation	11-10	11-7
Packing	11-11	11-7
Painting and marking	11-12	11-7
Support Subsystems:		
Description	11-4	11-2
General	11-3	11-1
Operation	11-5	11-3
Packing	11-6	11-3
Painting and marking.....	11-7	11-3
Scope	11-2	11-1
Amatol	2-17e	2-15
Ammonium picrate	2-17g	2-16
Ammunition, basic types:		
Aerial mines	11-1—11-12	11-1—11-8
Artillery ammunition.....	4-1—4-22	4-1—4-34
Bombs (Deleted)		
Demolition materials	8-1—8-13	8-1—8-21
Grenades	6-1—6-10	6-1—6-15
Guided missiles	12-1—12-12	12-1—12-6
Land mines.....	7-1—7-11	7-1—7-12
Propellant actuated devices.....	13-1—13-7	13-1—13-7
Pyrotechnics	9-1—9-15	9-1—9-19
Rockets	5-1—5-12	5-1—5-7
Rocket motors	5-13—5-17	5-7—5-12
Small arms ammunition	3-1—3-22	3-1—3-17
Artillery ammunition:		
Blank	4-18	4-31
Boosters	4-11	4-18
Burster charge	4-10	4-18
Cartridge case	4-7	4-8
Classification	4-3	4-1
Dual purpose munitions	4-6i(12)	4-8
Dummy ammunition	4-16	4-29
Fuzes	4-12—4-14	4-18—4-23
Identification	4-2	4-1
Improved conventional munitions (ICM)	4-6i(11)	4-8
Marking.....	4-22	
Packing.....	4-21	4-34
Practice rounds.....	4-15	4-26
Precautions in firing	4-20	4-33
Precautions in handling	4-19	4-32
Primers.....	4-9	4-15
Projectiles.....	4-6	4-3
Propellant temperature indicators	4-8b(4)(e)	4-15
Propelling charges	4-8	4-9
Subcaliber ammunition	4-17	4-29
Types.....	4-4	4-1
Bangalore Torpedoes	8-11c	8-18
Basic types of ammunition. (See Ammunition, basic types.)		

	Paragraph	Page
Benite	2-13a	2-9
Bipropellant system (liquid propellants)	2-8b	2-5
Black powder	2-12	2-8
Blank ammunition (artillery)	4-18	4-31
Basting machines.....	8-10c(6)	8-18
Blister gases	2-21	2-19
Blood and nerve poisons.....	2-23	2-20
Bombs: DELETED		
Boobytrapping.....	7-7	7-6
Boosters, artillery ammunition	4-11	4-18
Boron-Potassium nitrate	2-13c	2-9
Bourrelet (projectile)	4-6b	4-3
Burster charge, artillery ammunition	4-10	4-18
Calibration.....	-5g	1-3
Cap crimpers	8-10c(17)	8-18
Card data.....	1-10	1-12
Care and precautions. (See Specific items.)		
Cartridges		
Grenade (rifle)	6-4a	6-6
Photoflash	9-11	9-18
Chemical agents (see also Gases):		
Blister gases	2-21	2-19
Blood and nerve poisons	2-23	2-20
Choking gases	2-22	2-20
Classification	2-20	2-19
General	2-19	2-19
Identification of ammunition containing chemical agents.....	2-29	2-23
Incendiaries	2-26	2-22
Marking of ammunition containing chemical agents	2-29	2-23
Miscellaneous.....	2-28	2-23
Screening smokes	2-25	2-21
Training and riot control gases	2-24	2-21
Choking gases (phosgene).....	2-22b	2-20
Classification:		
Ammunition	1-3	1-1
Chemical agents	2-19	2-19
CN-DM (tear gas and Adamsite).....	2-24c, f	2-21
Color coding	1-6d	1-5
Composite propellants. (See Propellants.)		
Composition A.....	2-17	2-17
Composition B.....	2-17p	2-17
Composition C (series)	2-17q	2-18
Cyanogen chloride (CK)	223c	2-20
DDNP	2-18c	2-19
Definitions, general (see also Specific items)	1-3	1-1
Demolition explosives	2-17	2-13
Demolition materials:		
Care and precautions in handling	8-12	8-21
Classification	8-2	8-1
Demolition charges	8-3--8-1le	8-1
Demolition kits	8-11	8-18
Detonating cord	8-9	8-11
Detonators	8-5	8-6
Destructors	8-6	8-8

	Paragraph	Page
Firing devices	8-10	8-12
General	8-1	8-1
Igniters.....	8-7	8-10
Packaging and marking.....	8-13	8-21
Priming and initiating materials	8-4	8-6
Double-base propellants. (See Propellants.)		
DP (diphosgene)	2-22c	2-20
Dynamite	2-17l	2-17
Earth rod explosive kit	8-11d	8-18
Eimite	2-13b	2-9
Explosive and chemical agents:		
Chemical agents	2-19-2-29	2-19-2-23
High explosives	2-15-2-18	2-11-2-18
Low explosives	2-11-2-14	2-6-2-9
Propellants.....	2-1-2-9	2-1-2-5
Explosive charges. (See Demolition charges.)		
Explosive destructors.....	8-6	8-8
Explosive trains:		
Fuze explosive	2-12c(2)	2-8
High explosive	2-15-5-4a	2-11-5-2
Low explosive	2-11	2-6
Propellant explosive.....	5-4b	5-2
Fires, reports of.....	1-2c	1-1
Firing data.....	1-11	1-12
Firing devices, demolition	8-10	8-12
Flame-thrower fuels	2-27	2-23
Flares. (See Pyrotechnics.)		
Forms	1-2	1-1
Fragmentation explosives	2-17	2-13
FS	2-25c	2-22
Fuzes:		
Artillery ammunition.....	4-12	4-18
Bombs.....	10-4	10-11
Guided missiles (Safety and arming devices).....	12-8	123
Land mines.....	7-3b, 7b, 7-5b	7-1, 7-4
Rockets.....	5-13	5-7
Galvanometer, blasting.....	8-10c()	8-18
Gases (see also Chemical agents):		
Blister	-21	2-19
Blood and nerve poisons.....	2-23	2-20
Casualty.....	2-20a(1)	2-19
Choking	2-22	2-20
Military.....	2-20a	2-19
Simulated military	2-20d	2-20
Training and riot control	2-20a(2)	2-19
GB gas.....	2-23d	2-20
Grading ammunition.....	1-8	1-12
Grenades:		
Adapters and clips	6-4b, d	6-6, 6-7
Care and precautions in handling	6-7	615
Classification	6-2	6-1
General 2.....	1	6-1
Grenade cartridges	6-4c	6-6
Hand.....	6-3	6-3
Grenade launcher	6-4a	6-6
Packing.....	6-6	6-12
Painting and marking.....	6-6	6-12
Precautions in firing.....	6-9	6-15
Rifle grenades.....	6-4	6-6
Special precautions.....	6-10	6-15
Types.....	6-5	6-7

	Paragraph	Page
Guided missiles:		
Aerodynamic structure	12-4	12-2
Care, handling, and preservation	12-11	12-6
Classification	12-2	12-2
Control and guidance systems	12-5	12-2
Electrical power system	12-9	12-5
General	12-1	12-1
Identification	12-3	12-2
Packing and marking	12-12	12-6
Launchers	12-10	12-5
Propulsion system	12-6	12-3
Safety and arming devices	12-8	12-3
Warheads	12-7	12-3
Hand grenades. (See Grenades.)		
H (mustard gas)	2-21a	2-19
HBX	2-17n	2-17
HC	2-25d	2-22
HD	2-21b	2-19
HL	2-21f	2-21
HMX	2-17r	2-21
HN-1	2-21c(1)	2-19
HN-2	2-21c(2)	2-20
HN-3	2-21c(3)	2-20
HT	2-21d	2-20
High explosives:		
Classification	2-16	2-13
Definition and terms	2-1a	2-11
Demolition and fragmentation	2-17	2-13
General	2-15	2-11
High explosive train	2-15b	2-12
Initiating and priming:		
Diazodinitrophenol (DDNP)	2-18c	2-19
Lead azide	2-18a	2-18
Lead styphnate	2-18b	2-18
Primer compositions	2-15a(9)	2-11
Hydrocyanic acid (AC)	2-23b	2-20
Identification of ammunition:		
Ammunition containing hazardous filler	1-6b	1-3
Data card	1-4f (4)	1-3
DODAC	1-4c	1-2
FIIN	1-4b	1-2
FSN	1-4d	1-2
Lot number	1-4f	1-2
Marking	1-5	1-3
Model	1-4e	1-2
Standard nomenclature	1-4a	1-2
Type designation	1-4	1-2
Igniters (time blasting fuse)	8-7	8-10
Incendiaries:		
Flame-thrower fuels	2-27	2-23
Incendiary mixture (PTI) (PTV)	2-26f	2-23
Incendiary oils (IM and NP)	2-26d, e	2-23
Magnesium	2-26c	2-22
Thermate	2-26f	2-23
Thermite	2-26a	2-22
Inspection	1-8	1-12
Land mines:		
Antipersonnel mines	7-3, 7-4	7-1
Antitank mines	7-5, 7-6	7-4
Boobytrapping	7-7	7-6
Care and precautions in handling	7-10	7-10
Chemical mines	7-8a	7-8
Classification and identification	7-2	7-1

	Paragraph	Page
Land mines-Continued		
Firing devices	7-9	7-10
General.....	7-1	7-1
Incendiary bursters.....	7-8b	7-9
Packing and marking	7-11	7-12
Launchers, rocket.....	5-1	5-6
Lead azide	2-18a	2-18
Lead styphnate.....	2-18b	2-18
Lewisite (L).....	2-21e	2-20
Liquid propellants. (See Propellants.)		
Lot number.....	1-4f	1-2
Low explosives:		
Black powder	2-12	2-8
Characteristics	2-11c	2-6
Definition	2-11a	2-6
General	2-11	2-6
Low-explosive train.....	2-11d	2-6
Pyrotechnic compositions	2-14	2-9
Magnesium	2-26c	2-22
Malfunctions.....	1-2d	1-1
Marking (see also Specific items):	1-7	1-12
Mines (See Land or Aerial mines.)		
Monopropellant system (liquid propellants)	2-8a	2-5
Mox-type mixtures.....	2-13d	2-9
Mustard gas (H)	2-21a	2-19
Mustard gas, simulated	2-28a	2-23
Nerve poisons	2-23a	2-20
Nitrocellulose propellants	2-2a	2-1
Nitrostarch explosives	2-17k	2-16
Nomenclature.....	1-4a	1-2
Ogive (projectile)	4-6a	4-3
Packing (see also Specific items).....	1-7	1-12
Painting.....	1-6	1-3
PETN.....	2-17b	2-15
Pentolite.....	2-17i	2-16
Phosgene (CG)	2-22b	2-20
Photoflash cartridges.....	9-11	9-18
Picratol.....	2-17h	2-16
Picric acid	2-17f	2-16
Precautions (handling and firing). (See also Specific items.)		
Precautions in use of ammunition	1-10	1-12
Primer compositions (high explosives)	2-15a(9)	2-11
Primers:		
Artillery ammunition.....	4-9	4-15
Demolition equipment.....	8-4	8-6
Small arms ammunition	3-2c	3-6
Priming and initiating materials (demolition equipment).....	8-4	8-6
Priority of issue	1-9	1-12
Projectiles. (See Artillery ammunition.)		
Propellant actuated devices:		
Care and precautions in handling.....	13-7	13-7
Cartridges	13-6	13-4
Cutters.....	13-4	13-1
Explosive embedment anchor.....	13-3	13-1
General.....	13-1	13-1
Identification	13-2	13-1
Parachute ejector.....	13-5	13-1
Propellant temperature indicators.....	4-8b(4)(e)	4-1

	Paragraph	Page
Propellants:		
Characteristics	2-3	2-2
Classification	2-2	2-1
Composite	2-6	2-5
Double-base	2-5	2-4
For small arms.....	2-4d	2-4
General.....	2-1	2-1
Liquid	2-7-2-10	2-5
Nitrocellulose	2-2a	2-1
Single-base.....	2-4	24
Solid	2-1-2-6	2-1-2-6
Propelling charges. (See Artillery ammunition.)		
Pyrotechnics:		
Bombs (Deleted)		
Candlepower (table 9-1).....	9-3	9-3
Care and precautions in handling	9-13	9-20.1
Classification	9-2	9
Complete round	9-1a	9-1
Flares:		
Aircraft.....	9-5	9-4
Ground	9-6	9-7
Guide	9-7	9-7
Ramjet engine igniters.....	9-8	9-7
Tracking	9-9	9-7
General.....	9-1	9-1
Identification	9-1d	9-1
Ignition train.....	9-1b	9-1
Packing and marking	9-15	9-19
Photoflash cartridges	9-11	9-19
Precautions in firing.....	9-14	9-19
Projection	9-1e	9-1
Pyrotechnic compositions	9-1c	9-1
Signals	9-10	9-7
Training pyrotechnics.....	9-12	9-19
Types	9-4	9-4
Visibility	9-3	9-3
RDX	2-17c	2-15
Recommended changes.....	1-2f	1-1
Reports	1-2	1-1
Rifle grenades (See Grenades.)		
Rockets:		
Aircraft	5-25, 5-26	5-13
Application.....	5-2	5-1
Classification	5-4	5-1
Complete round, general.....	5-5	5-3
Explosive train	5-6	5-3
Fuzes	5-17, 5-18	5-6
General.....	5-1	5-1
Ground-to-ground	5-23, 5-24	5-12, 5-13
Identification	5-19	5-7
Launchers.....	5-15, 5-16	5-6
Marking.....	5-19	5-7
Motors	5-13, 5-14	5-4, 5-5
Painting	5-19	5-7
Packing.....	5-20	5-7
Precautions.....	5-27-5-30	5-13, 5-14
Principles of rocket propulsion		
Shoulder-fired	5-21, 5-22	5-11
Warheads	5-7-5-12	5-3, 5-4
Rotating band (projectile)	4-6d	4-3
Safety, reports.....	1-2e	1-1
Scope of manual	1-1	1-1

	Paragraph	Page
Scatterable mines:		
Canister assembly	11-5b	11-6
Container CNU-79/E	11-6b	11-8
Container M602	11-6c	11-8
Dispenser pallet	11-5d	11:6
Firing	11-5e	11-7
General.....	11-3	11-1
Mine dispenser	11-5a	11-6
Mine release	11.5c	11-6
Operational procedures	11-2b	11-1
Painting and marking.....	11-7b	11-8
Practice and inert types	11-4b	11-6
Shipping and storage containers	11-6	11-8
Screening smokes:		
Hexachloroethane-zinc (HC)	2-25d	2-22
Sulfur trioxide-chorosulfonic acid (FS)	2-25c	2-22
White phosphorus (WP) and plasticized white phosphorus IPWP)	2-22a,b	2-20
Security classification.....	1-3c(2)	1-2
Shipping regulations, classification of ammunition.....	1-3c	1-2
Signals, pyrotechnic. (See Pyrotechnics.)		
Simulators	9-12	9-19
Single-base propellants. (See Propellants.)		
Small arms ammunition:		
Care, handling and preservation	3-21	3-16
Cartridges:		
Armor-piercing.....	3-6	3-11
Armor-piercing-incendiary	3-7	3-11
Armor-piercing-incendiary-tracer	3-8	3-11
Ball	3-3	3-10
Blank	3-11	3-12
Duplex	3-9	3-11
Dummy (See Special purpose.)		
Frangible	3-13	3-12
Grenade	3-12	3-12
High-explosive incendiary.....	3-15	3-12
High-pressure test	3-18	3-15
Incendiary	3-14	3-12
Match	3-5	3-11
Special purpose.....	3-18	3-14
Spotter-tracer	3-10	3-12
TP, TP-T	3-16,3-17	3-12
Tracer.....	3-4	3-10
General.....	3-1	3-1
Metallic links and clips	3-19	3-15
Packing and identification marking	3-20	3-16
Precautions in firing	3-22	3-17
Types of cartridges	3-3-3-18	3-10
Smoke, screening. (See Screening smoke.)		
Solid propellant. (See Propellants.)		
Subcaliber ammunition	4-17	4-29

	Paragraph	Page
Tables:		
Primary use code (table 1-1)	1-6	1-3
Ammunition color coding (table 1-2)	1-6	1-3
Characteristics of low explosives (table 2-1)	2-14	2-9
Pyrotechnic types and candlepower (table 9-1)	9-3	9-3
Tear gas (CN, CNB and CNS)	2-24	2-21
Tetryl	13	
Tetrytol	2-17	2-16
Thermate (TH)	22	
Thermite (TH)	2-26a	2-22
TNT	2-17a	2-15
Trainer, artillery field	4-15d	4-28
Training (practice):		
Artillery ammunition	4-15	4-26
Gases	2-24	2-21
Grenades	6-3b(2)	8-1-6
Inert firing devices.....	8-10b(3)	8-15
Practice mines	7-4,7-6	7-1,7-6
Pyrotechnics	9-12	9-19
Small-arms ammunition	3-17,3-18	3-14
Tritonal	2-17m	2-17
VX gas	2-23e	2-21
Warheads:		
Chemical and smoke.....	5-10	5-4
Flechette	5-7	5-3
High explosive	5-8	5-4
High-explosive antitank.....	5-9	5-4
Practice	5-12	5-4
Spotting	5-11	5-4
White phosphorus (WP) and plasticized white phosphorus (PWP)	2-25a, b	2-22
Windshield (projectile).....	4-6a	4-3

By Order of the Secretary of the Army:

W. C. WESTMORELAND,
General, United States Army,
Chief of Staff.

Official:

KENNETH G. WICKHAM,
Major General, United States Army,
The Adjutant General.

Distribution:

Active Army:

USASA (2)
 DCSLOG (2)
 CNGB (1)
 CofEngrs (4)
 USAMB(2)
 USAMC(12)
 USAECOM(2)
 USAMECOM(2)
 USAWECOM(2)
 USAMUCOM(10)
 USAMICOM(10)
 USATACOM(2)
 USATECOM(2)
 USCONARC(3)
 ARADCOM(2)
 ARADCOM Rgn (2)
 OS Maj Comd (2) except
 USAREUR (5)
 LOGCOMD (2)
 MDW (1)
 Armies (2) except
 First (5)
 Corps (2)
 Div (2)
 Instl (2)
 Svc Colleges (20)
 Log Con Ofc (2)

Br Svc Sch (12) except
 USAOC&S (200)
 USACMLCS (100)
 USA FA Sch (100)
 USAARMS (100)
 USA Msl & Muns CEO & Sch (300)
 Army Dep (2) except
 SVAD (50)
 LEAD (4)
 Gen Dep (2)
 Ord Sec, Gen Dep (5)
 Ord Dep (5)
 Arsenal (4) except
 Edgewood (10)
 Picatinny (75)
 PG (2)
 PMS Sr Div Ord Units (1)
 POE (2)
 USARMIS (2)
 MAAG (2)
 MTMTS (2)
 EAMTMTS (2)
 WAMTMTS (2)
 JBUSMC (2)
 JUSMAAG (2)
 Fld Comd, DASA (1)

ARNG: State AG (3); units-same as Active Army except allowance is one (1) copy each

USAR: None

