

CONFIDENTIAL

NAVWEPS OP 3345

FIRST REVISION

0609-334-5000

**CLUSTER BOMB MARK 15 MOD 0
(SADEYE ANTIPERSONNEL WEAPON SYSTEM)**

DESCRIPTION AND OPERATION (U)

NOTICE: This material contains information affecting the national defense of the United States within the meaning of the Espionage Laws, Title 18, U.S.C., Sections 793 and 794, the transmission or revelation of which in any manner to an unauthorized person is prohibited by law.

**PUBLISHED BY DIRECTION OF
THE CHIEF OF THE BUREAU OF NAVAL WEAPONS**

CONFIDENTIAL

CONFIDENTIAL

NAVWEPS OP 3345

GROUP 4
Downgraded at 3-year intervals;
declassified after 12 years.

FIRST REVISION

**CLUSTER BOMB MARK 15 MOD 0
(SADEYE ANTIPERSONNEL WEAPON SYSTEM)**

DESCRIPTION AND OPERATION (U)

**THIS PUBLICATION SUPERSEDES NAVWEPS OP 3345 DATED
15 DECEMBER 1964**

NOTICE: This material contains information affecting the national defense of the United States within the meaning of the Espionage Laws, Title 18, U.S.C., Sections 793 and 794, the transmission or revelation of which in any manner to an unauthorized person is prohibited by law.

**PUBLISHED BY DIRECTION OF
THE CHIEF OF THE BUREAU OF NAVAL WEAPONS**

CONFIDENTIAL

1 APRIL 1965

LIST OF EFFECTIVE PAGES

Total number of pages in this publication is 26 consisting of the following:

<u>Page</u>	<u>Issue</u>
Title	Original
A	Original
Foreword	Original
iii through vi	Original
1-1	Original
1-2 blank	Original
2-1 through 2-4	Original
3-1	Original
3-2 blank	Original
4-1 through 4-6	Original
5-1 and 5-2	Original
6-1	Original
6-2 blank	Original

Authority NND 84869
DECLASSIFIED

ILLUSTRATIONS

Figure	Page
Frontispiece.....	vi
2-1. Sectioned View of Dispenser.....	2-2
2-2. Fins	2-2
2-3. Arming Wire, Fahnestock Clips, M907 Mechanical Time Fuze, and Arming Vane	2-3
2-4. Container for Dispenser	2-4
3-1. Case Separation Action.....	3-1
4-1. Lid Lifted from Container	4-1
4-2. Chain Hoist Attached to Dispenser.....	4-1
4-3. Dispenser on Aero 12B Bomb Skid With Soft-Shell Adapter Slings.....	4-2
4-4. Fins Attached to Dispenser.....	4-2
4-5. Arming Wire Inserted Through Dispenser	4-3
4-6. Fuze Screwed Into Fuze Well of Dispenser.....	4-3
4-7. Arming Wire Aligned.....	4-3
4-8. Fahnestock Clips Attached to Arming Wire	4-4
4-9. Sway Braces Tightened on Bomb.....	4-5
4-10. Lever Locking Pin Assembly Removed.....	4-5
4-11. Safety Wire Removed.....	4-5

Authority NND 84889
CONFIDENTIAL

CONFIDENTIAL

SAFETY SUMMARY

The following WARNING is repeated from the Text for the protection of personnel.

WARNING

DO NOT remove the fuze safety wire until the weapon is on the aircraft and the aircraft is ready for takeoff. (Page 4-4)

WARNING

Bomblets, accidentally released from the dispenser, or exposed to view, will not be handled or moved under any circumstances. Personnel in the vicinity of exposed bomblets will be reported to explosive ordnance personnel authorized to dispose of exposed bomblets. At all times, security will be maintained in accordance with OPNAVINST 5510.16 as applicable, and implementing instructions of major command concerned.

Disassembly of this weapon beyond the extent prescribed in this manual is strictly forbidden.

The cargo within the bomb dispenser is extremely lethal. Perform all operations carefully.

Exercise care, especially during handling, unpacking, and repacking operations, to avoid denting or otherwise damaging the dispenser. These weapons should be moved with approved handling equipment only, and will not be rolled, dragged, dropped, or otherwise roughly handled.

CONFIDENTIAL

The following CAUTION is repeated from the text because if not strictly observed the effectiveness of the weapon may be destroyed.

CAUTION

DO NOT use suspension lugs for handling the weapon. The suspension bands are accurately positioned to assure proper alignment when installed on the bomb rack. (Page 4-1)

CAUTION

When stored or handled outside its container (other than slinging), the dispenser must be supported at the hard spots ("CHOCK" markings) only.

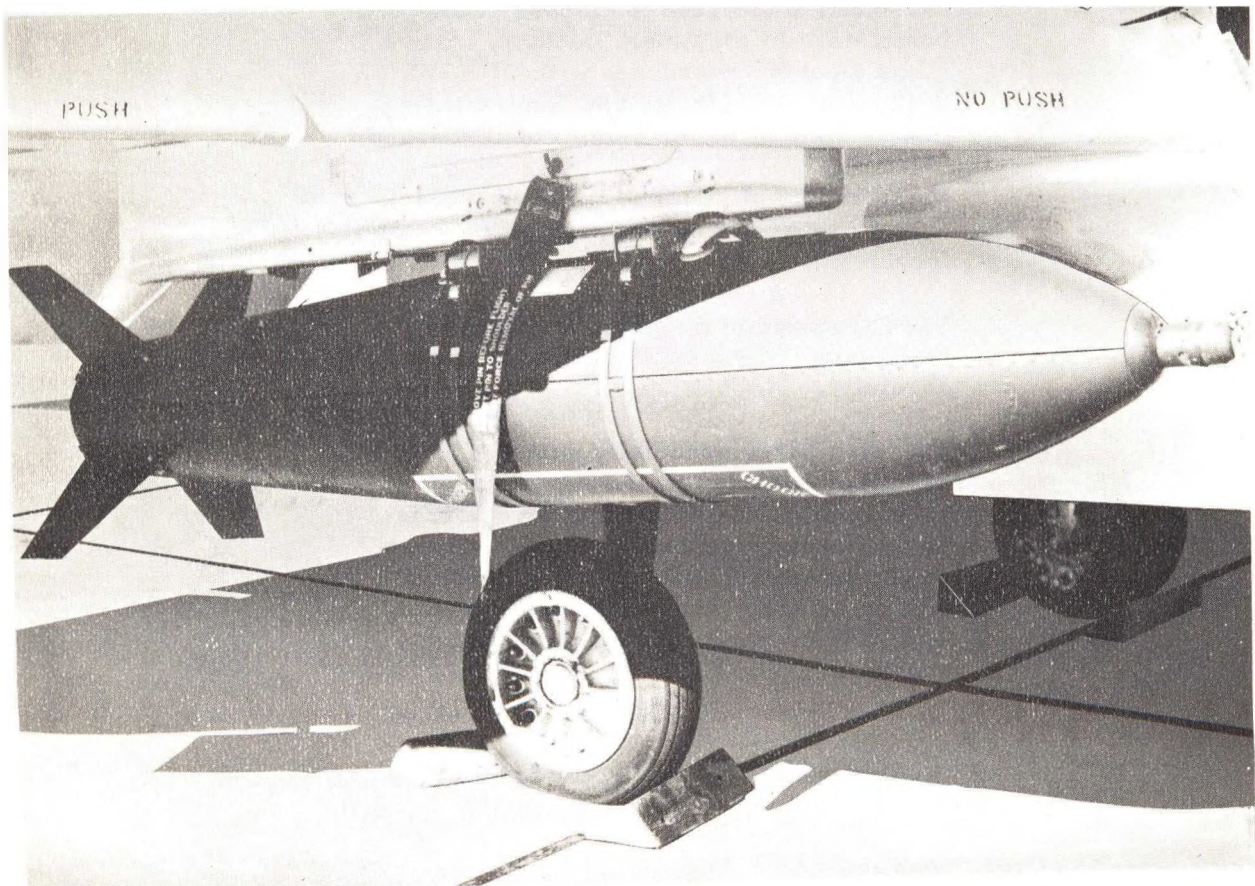

Cluster Bomb Mk 15 Mod 0 (Sadeye) Mounted on Aircraft.

Authority AND 84879
CONFIDENTIAL

CONFIDENTIAL

Chapter 1

INTRODUCTION

The Universal Weapon Dispenser Mk 5 Mod 0 (Sadeye) is a low-drag dispenser used to saturate large elliptical areas with in-stock bomblets and submissiles as payloads (frontispiece). For this publication, the Army developed M40 bomblet is described as the payload. The weapon dispenser, when loaded with M40 bomblets, is designated the Cluster Bomb Mk 15 Mod 0.

Sadeye can be carried by all modern high-performance aircraft equipped with standard 14-inch suspension bomb racks, can be delivered in all modes (level, glide, dive, toss, and loft), and has a highly predictable ballistic trajectory. As an antipersonnel weapon, it is effective in close support against mortar, gun emplacements, and exposed troops.

1-1 GENERAL CHARACTERISTICS

The general characteristics of the Cluster Bomb Mk 15 Mod 0 are as follows:

- Length, in.....88
- Diameter, in.....16
- Weight, empty, lb.....150
- Weight, loaded, lb.....750
- Fin span, in..... 30
- CG, in. from nose end...40

1-2 OPERATING CHARACTERISTICS

The operating characteristics of the Cluster Bomb Mk 15 Mod 0 are as follows:

- Release altitude, ft.....2000 to 10,000
- Release speed (max), knots..... 500
- Saturation pattern.... Elliptical, several hundred feet in diameter

- Operating temperature, °F....-65 to +160
- Storage temperature limits, °F..... -65 to +160

1-3 MAJOR COMPONENTS AND CONTAINERS

The major components of the Cluster Bomb Mk 15 Mod 0 and their containers are listed in the following paragraphs.

1-3.1 COMPONENTS

- Mk 5 Mod 0 universal weapon dispenser body
- Four fins (packaged separately)
- AN-M6A2 arming wire with Fahnestock clips
- M907 mechanical time fuze with Arming Vane T5E2
- 2100 M40 bomblets

1-3.2 CONTAINERS

- Shipping and Storage Container Mk 320 Mod 0 for dispenser and fins
- Container for fuzes and arming vanes (no mark or mod assigned as yet)

1-4 HANDLING EQUIPMENT

The following types of equipment are required for handling and transporting the Cluster Bomb Mk 15 Mod 0:

- Hoist Mk 8 Mod 0 or Mk 14 Mod 0
- Aero 12B or 12C Bomb Skid (with soft-shell adapter slings)
- Forklift truck
- Mk 7 Bomb Trailer

CONFIDENTIAL

CONFIDENTIAL

Chapter 2

PHYSICAL DESCRIPTION

The Cluster Bomb Mk 15 Mod 0 is a semimonocoque (skin-stressed) structure with a low-drag aerodynamic profile, loaded with M40 bomblets. The fins and fuze, as well as the arming vane and arming wire, are attached by the using activity.

The major components of the Cluster Bomb Mk 15 Mod 0 are discussed in the following paragraphs.

2-1 UNIVERSAL WEAPON DISPENSER MK 5 MOD 0

The dispenser is divided in half longitudinally. The upper half contains the strongback section; the lower half contains a hardshell doubler for chocking purposes. The skin of the dispenser is of low carbon steel (1008 to 1020). The two halves are locked together by a nose locking ring at the forward end and by an end plate screwed to the after end. Two suspension bands, approximately 32 1/2 and 45 inches from the forward end, encircle the two halves. The bands are held by levers with locking pins. Midway between the two suspension bands is the hoisting lug receptacle. Openings for the arming wire are covered with appropriate decals.

The dispenser is shipped from the manufacturer as an integral unit. The empty dispenser weighs approximately 150 pounds. Figure 2-1 shows a sectioned view of the dispenser.

At the loading activity, the end plate and loading port plug are removed, and the bomblets are loaded into the dispenser, using special remotely operated machinery. The loading port plug and end plate are then reassembled on the dispenser and the loaded unit is ready for issue to the Fleet. The dispenser, when loaded with approximately 2100 M40 bomblets, weighs about 750 pounds.

2-2 FINS

Four fins, figure 2-2, are attached to the after end of the dispenser body. They are canted 1 1/4 degrees to impart spin to the dispenser when released from the aircraft.

The fins are of cast aluminum alloy with one coat of olive drab enamel over two primer coats. The fins are shipped in a cardboard carton inside the container for the dispenser. Capscrews and washers are also shipped in the carton and are used to attach the fins to the body of the dispenser.

2-3 M907 MECHANICAL TIME FUZE

The M907 fuze, figure 2-3, is an air-armed, air-burst mechanical time fuze with a black-powder booster. It is an in-stock item developed by the U. S. Army.

CONFIDENTIAL

2-1

- ① ARMING WIRE (OPTIONAL LOCATION)
- ② LOCKING LEVER
- ③ SUSPENSION LUG
- ④ ARMING WIRE
- ⑤ LEVER RETAINING CLIP
- ⑥ HOISTING LUG
- ⑦ SUSPENSION BAND ASSEMBLY

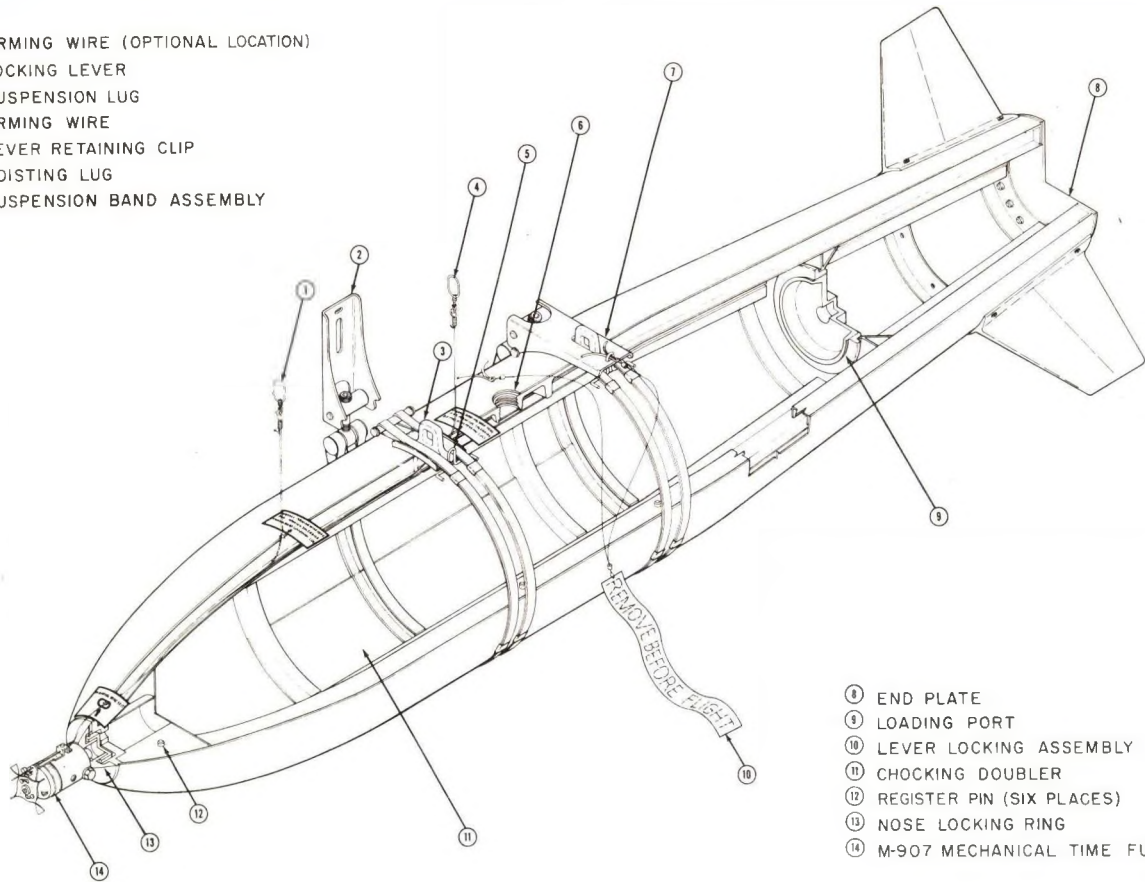

- ⑧ END PLATE
- ⑨ LOADING PORT
- ⑩ LEVER LOCKING ASSEMBLY
- ⑪ CHOCKING DOUBLER
- ⑫ REGISTER PIN (SIX PLACES)
- ⑬ NOSE LOCKING RING
- ⑭ M-907 MECHANICAL TIME FUZE

Figure 2-1. Sectioned View of Dispenser

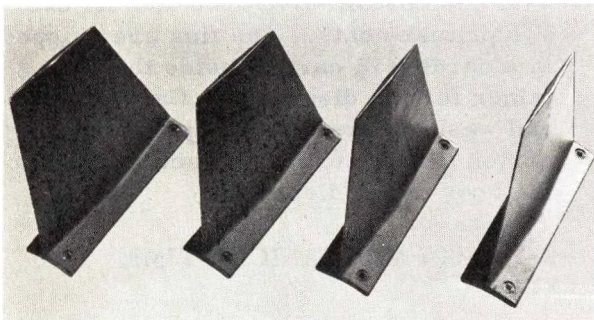

Figure 2-2. Fins

The M907 fuze is attached to the nose of the weapon dispenser and uses a T5E2 arming vane, figure 2-3. The fuze has a governor mechanism that provides a constant rate of arming independent of vane input speed and function times

(set by weapons assembly personnel on the ground) from 4 to 92 seconds in 0.5 - second increments (4 seconds is the functioning time generally used for the weapon dispenser). The arming time of the fuze is built in and is approximately 60 percent of the set functioning time (± 20 percent).

The M907 fuze has an interrupted firing train until arming is completed. Visual means of making sure the fuze is unarmed are provided by two viewing ports and the seal over the slider cavity.

Twelve fuzes, individually wrapped in styrofoam and pressure-sealed in a barrier bag, are shipped in a wooden crate. Arming vanes (T5EZ) are shipped with the fuzes.

Authority NND 8488

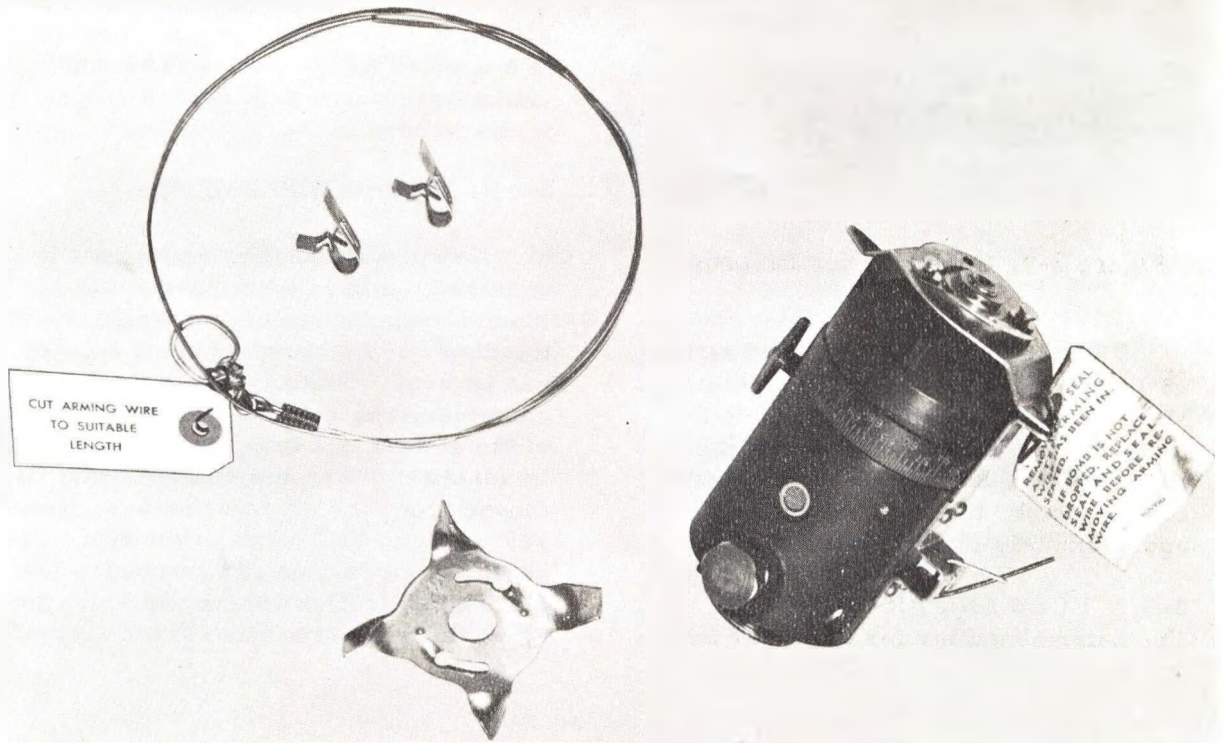

Figure 2-3. Arming Wire, Fahnestock Clips, M907 Mechanical Time Fuze, and Arming Vane.

2-4 ARMING WIRE

The arming wire to be used is a standard hard brass Arming Wire AN-M6A2, figure 2-3. The looped end of the arming wire is attached to the appropriate bomb rack arming wire solenoid; the other end is threaded through the dispenser body, then through openings in the fuze and arming vane plate, and secured with two Fahnestock clips as is normal for aircraft ordnance fuzing. The entrance points for the arming wire are indicated on decals on the dispenser body. For those bomb racks equipped with arming wire attach solenoids between the suspension lugs, the arming wire is inserted through the aft entrance hole; for bomb racks with solenoids forward of the lugs, the arming wire is inserted through the forward entrance hole.

2-5 CONTAINERS

2-5.1 UNIVERSAL WEAPON DISPENSER. The metal, reusable Shipping and Storage Container Mk 320 Mod 0, used to ship the weapon dispenser, is of clamshell construction, held together by 10 clamps, figure 2-4. Two handles, one at each end, are used to lift the top half of the container but are not used for lifting the container with a loaded dispenser.

Two lift pockets on the bottom of the container are used for forklift handling of the loaded dispenser in its container.

A cardboard carton in the container is used to store fins, socket-head cap-screws, and washers.

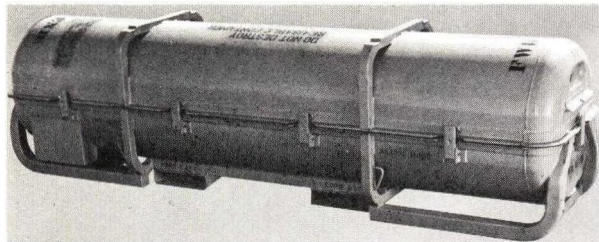

Figure 2-4. Container for Dispenser.

The container is 95 1/2 inches long, 23 1/8 inches wide, and 24 15/16 inches high. The stacking height is 24 7/8 inches. The empty container weighs about 350 pounds; with a Mk 15 Mod 0 cluster bomb, the total weight is approximately 1100 pounds.

2-5.2 FUZE AND ARMING VANE.

The outer container for the M907 fuze

and arming vane (T5E2) is a disposable wooden crate. Each fuze is individually packed in styrofoam and pressure-sealed in a barrier bag. Twelve fuzes and arming vanes are then packed and shipped in the wooden crate.

2-6 HANDLING EQUIPMENT

No special handling equipment is required for the Cluster Bomb Mk 15 Mod 0. A hoisting lug is furnished with the dispenser so that standard hoists can be used. When transported in the container, two pockets on the bottom of the container can be used in handling by forklift. When the cluster bomb is moved from one area to another, Aero 12B or Aero 12C bomb skids with soft-shell adapter slings can be used. The Mk 7 bomb trailer can be used also to move the weapon to land-based aircraft.

Chapter 3

FUNCTIONAL DESCRIPTION

The Mk 15 Mod 0 cluster bomb is released from the aircraft in the same manner as any standard general-purpose bomb. Upon release, the suspension bands open automatically and drop free of the dispenser body. Simultaneously, the arming wire is withdrawn, initiating the fuze time delay cycle.

nose locking ring are blown forward unlocking the forward end of the dispenser. Ram air forces, acting on the dispenser, force the two halves apart, hinging them about the end plate. The payload is instantaneously dispensed to disperse and saturate an elliptical area several hundred feet in diameter.

When the fuze functions, the fuze booster is ignited and the fuze and

Figure 3-1 shows a sequence of case separation action.

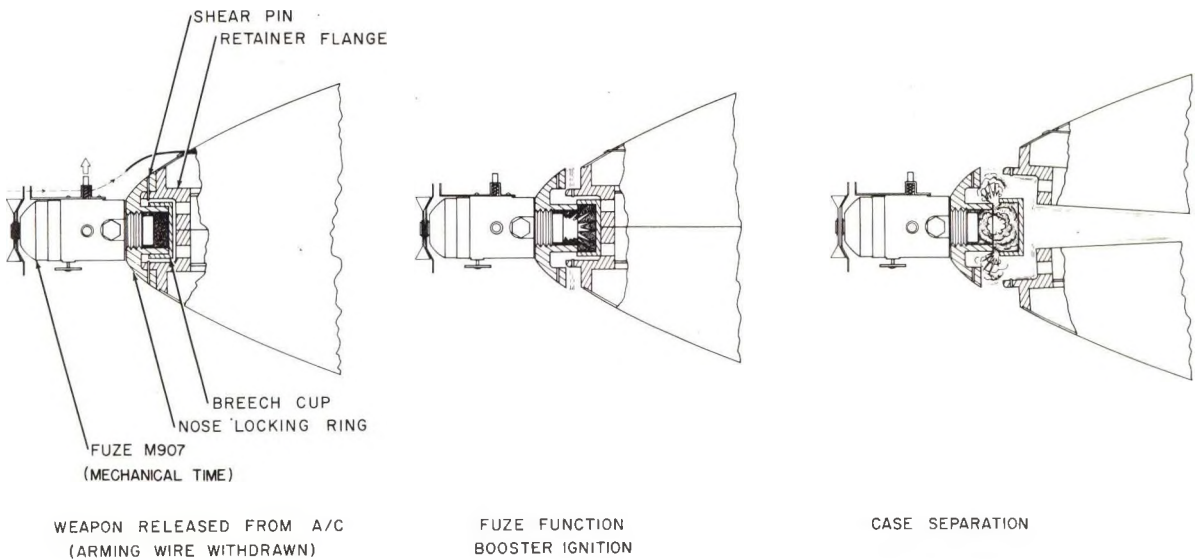

Figure 3-1. Case Separation Action

Chapter 4

OPERATION

The Cluster Bomb Mk 15 Mod 0 is received in the Mk 320 Mod 0 container. The fuzes and arming vanes are received in disposable wooden crates and are palletized. For decanning, a team of two men is required; for assembly, a team of two or three is required. Procedures for decanning, assembly, loading and unloading the aircraft, and disassembly are given in the following paragraphs.

4-1 DECANNING

When the container is received by the using activity the decanning is as follows:

1. Remove clamps that secure lid on metal shipping container.
2. Lift upper half (lid) of container off, figure 4-1.

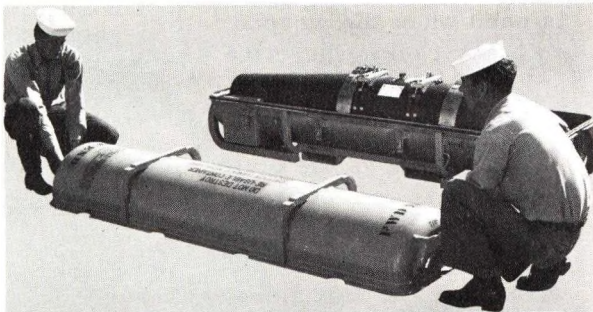

Figure 4-1. Lid Lifted from Container.

3. Release two retaining bands that hold weapon dispenser in container.

4. Place chain hoist directly over weapon dispenser and connect hoisting hook, with safety device, to hoisting lug, figure 4-2.

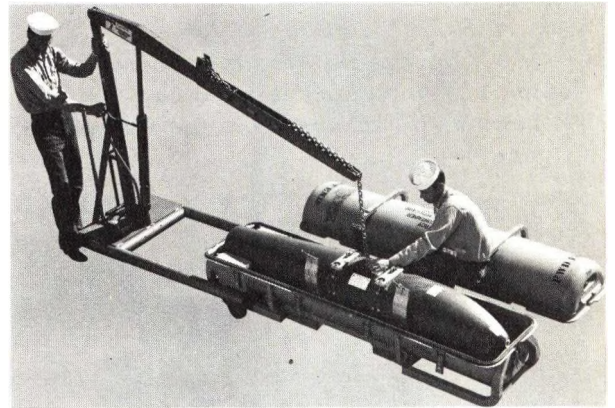

Figure 4-2. Chain Hoist Attached to Dispenser

CAUTION: DO NOT use suspension lugs for handling. The suspension bands are accurately positioned to assure proper alignment when installed on the bomb rack.

5. Lift cluster bomb clear of container and place on Aero 12B or 12C bomb skid with soft-shell adapter slings, figure 4-3.
6. Remove cardboard carton from metal shipping container and unpack four fins, capscrews, and washers.
7. Remove plastic thread protectors (16) from fin attachment holes.

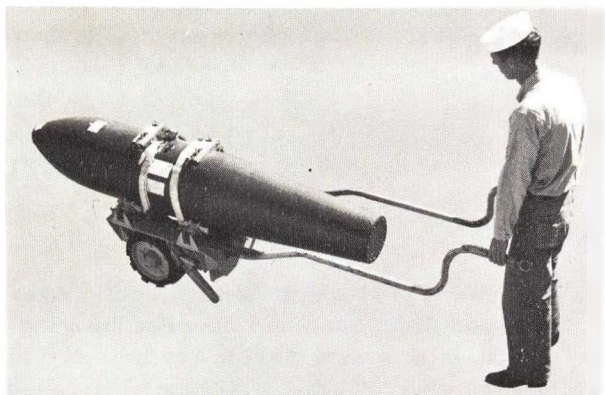

Figure 4-3. Dispenser on Aero 12B Bomb Skid With Soft-Shell Adapter Slings

8. Secure fins to after end of bomb, using 1/4-inch socket-head capscrews and washers from the fin carton, figure 4-4.



Figure 4-4. Fins Attached to Dispenser.

NOTE: The perpendicular portion of the fin is toward the after end of the weapon.

9. Tighten socket-head capscrews, using hexagonal wrench.

10. Move cluster bomb to appropriate magazine for stowage.

NOTE: The payload determines the type of magazine stowage required.

11. Remove fuzes and arming vanes from wooden crate and stow in HE magazines.

12. Return metal shipping container to appropriate ammunition stocking point. Dispose of wooden crate.

4-2 ASSEMBLY

When decanned components have been transported from stowage to the assembly area, proceed as follows:

1. Remove hoisting lug from dispenser.
2. Determine the arming wire attach point for the particular bomb rack on which cluster bomb is to be placed (see decals on dispenser body).
 - a. The small opening between the forward suspension band and the hoisting lug receptacle is used when the weapon is to be placed on bomb racks where the arming wire solenoid is located between the lug hooks.
 - b. The small opening between the nose and the forward suspension band is used when the weapon is to be placed on bomb racks where the arming wire solenoid is forward of the forward lug hook.

3. Remove the plastic plug from appropriate opening to be used for arming wire.

4. Punch an exit hole for arming wire, using a pencil or similar object.

5. Thread arming wire through designated opening until at least 1 foot of wire extends through the arming wire exit hole, figure 4-5.

6. Remove plastic thread protector from fuze well of bomb.

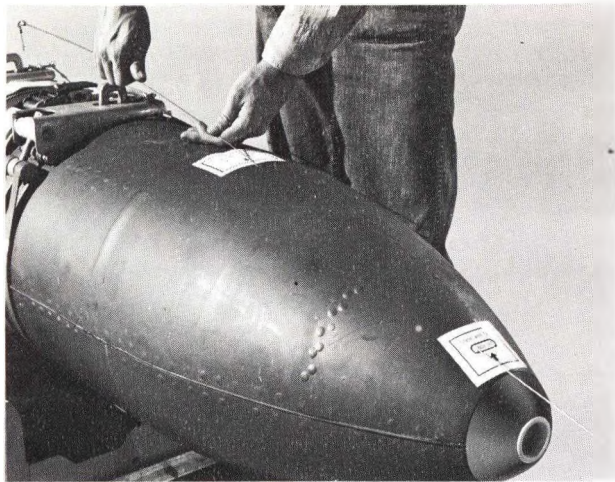

Figure 4-5. Arming Wire Inserted Through Dispenser

7. Remove M907 fuze from fuze container.

8. Place a star washer on threaded portion of fuze.

NOTE: Do not install the fuze without at least one star washer on the threaded portion of the fuze. Additional washers may be required, as indicated in the following steps.

9. Place fuze in fuze well of nose of dispenser and screw fuze clockwise until handtight, figure 4-6.

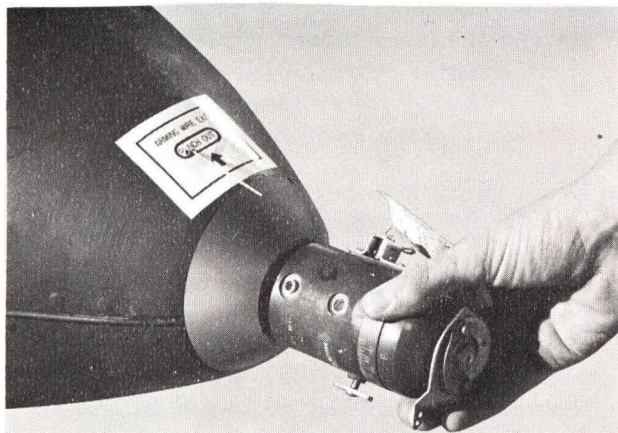

Figure 4-6. Fuze Screwed Into Fuze Well of Dispenser

10. Align arming wire bracket on side of fuze with arming wire exit hole within 45 degrees on either side, figure 4-7.

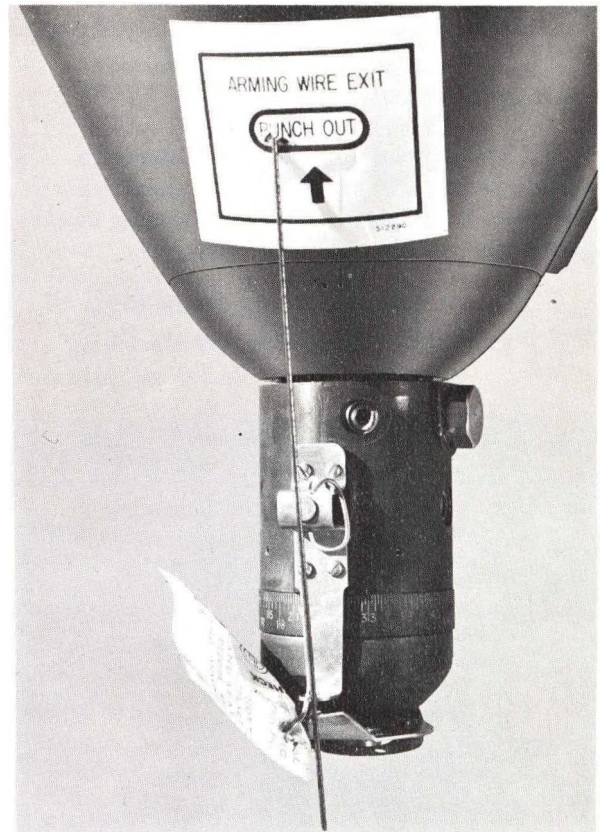

Figure 4-7. Arming Wire Aligned.

NOTE: This measurement can be made by sighting the arming wire bracket to determine if the bracket is between the fins on the upper half of the bomb. If the bracket extends beyond a line of the fins, remove the fuze and add an additional star washer to the threaded portion of the fuze. Continue to add star washers until the bracket lines up within 45 degrees on either side of the arming wire exit.

11. Place Arming Vane T5E2 on forward end of fuze.

NOTE: Name and part number of arming vane faces away from the weapon.

12. Turn arming vane clockwise until it is locked securely to fuze.

13. Thread arming wire through openings in fuze not used for safety wire and then through opening in arming vane plate.

14. Attach two Fahnestock clips to end of arming wire to secure it, figure 4-8.

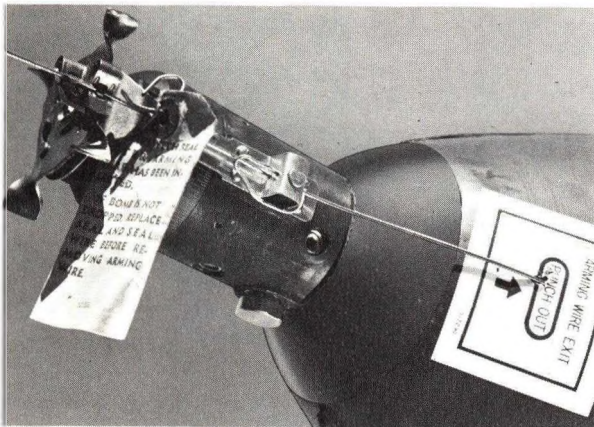

Figure 4-8. Fahnestock Clips Attached to Arming Wire.

WARNING

DO NOT remove the fuze safety wire at this time.

15. Set delay time of fuze as follows:

a. Unlock graduated ring dial by loosening the locking wing screw located on the fuze, opposite the safety wire.

b. Turn graduated ring dial to maximum time stop (92 seconds).

c. Turn graduated ring dial until correct time is aligned with white mark on body of fuze.

NOTE: When turning ring dial to desired time setting, DO NOT pass white mark or reverse motion of ring dial as this will cause errors in fuze functioning time. Repeat step b if necessary.

d. Relock graduated ring dial by tightening locking wing screw clockwise until handtight.

16. Move cluster bomb to aircraft.

4-3 AIRCRAFT LOADING

To attach the weapon to the bomb rack of the aircraft, proceed as follows:

1. Wheel bomb skid with bomb directly under aircraft bomb rack with fuze toward nose of aircraft.

2. Lift weapon to bomb rack.

NOTE: For land-based aircraft, Mk 7 Mod 1 bomb trailer may be used; for others, Mk 8 Mod 0 or Aero 14 hoist with appropriate slings may be used.

3. Raise weapon to bomb rack until suspension lugs are secure to bomb rack.

4. Tighten sway braces, figure 4-9.

5. Attach arming wire in arming wire solenoid of bomb rack. Take up slack in wire. Slip clips snugly against vane. Cut off excess arming wire, allowing the end to extend 2 to 3 inches past the vane and clips. The end of the wire must be free of kinks and burrs.

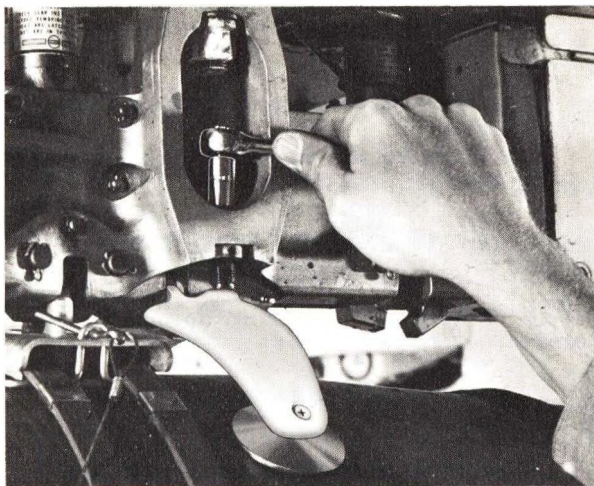

Figure 4-9. Sway Braces Tightened on Bomb.

6. Remove lever locking pin assembly, figure 4-10, from each suspension band by depressing levers, using 15-inch pinch bar or large screwdriver.

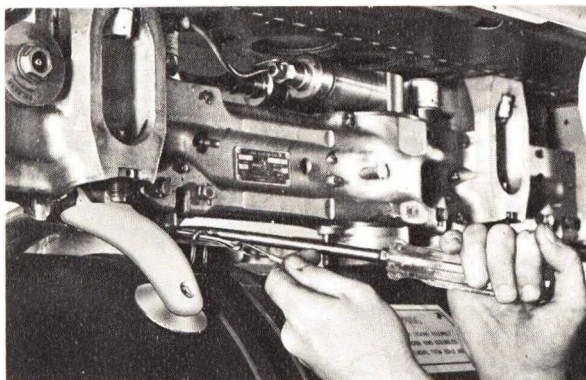

Figure 4-10. Lever Locking Pin Assembly Removed

7. Store lever locking pin assembly, in the event of return of the bomb.

8. Pull safety wire from fuze, figure 4-11.

9. Make the following checks of assembly before takeoff of aircraft.

a. Arming wire properly installed in fuze.

- b. Arming vane securely attached to fuze.
- c. Recheck time delay setting.
- d. Delay timing graduated ring dial securely locked in CORRECT position.

NOTE: DO NOT move ring dial. If moved comply with paragraph 4-2, assembly procedures (step 15).

e. Arming wire properly connected to arming wire solenoid.

f. Levers on suspension bands bearing on bomb rack hooks.

g. Lever locking pin assembly removed.

h. Safety wire removed from fuze.



Figure 4-11. Safety Wire Removed.

4-4 UNLOADING CLUSTER BOMB MK 15 MOD 0 FROM AIRCRAFT

If the aircraft returns with the bomb attached, proceed as follows:

- 1. Insert safety wire in fuze.
- 2. Insert lever locking pin assembly in each suspension band.

3. Disconnect arming wire from bomb rack arming wire solenoid.

4. Using Mk 8 or Mk 14 bomb hoist with appropriate slings, lower cluster bomb to Aero 12B or 12C bomb skid that has soft-shell adapter slings.

5. Transport unit to assembly area for disassembly or to ready-service stowage.

4-5 DISASSEMBLY

If a returned cluster bomb is to be stowed unassembled, proceed as follows:

1. Remove Fahnestock clips from arming wire.

2. Remove arming wire from fuze.

3. Replace the plastic plug in arming wire opening.

4. Remove arming vane from fuze by quarter turn counterclockwise.

5. Unscrew fuze from bomb and return to fuze container.

6. Place plastic thread protector in fuze well.

7. Place hoisting lug in opening between the two suspension bands.

8. Move weapon, fuze, and arming vane to designated magazine stowage.

CONFIDENTIAL

Chapter 5

SHIPMENT AND STORAGE

5-1 GENERAL MAINTENANCE IN STORAGE

a. When the dispenser is not being installed on the aircraft or otherwise handled, it should be kept in its container except when aboard an aircraft carrier.

b. Each time a dispenser is removed from its container, inspect all visible surfaces for cracks, excessive wear, corrosion, and similar defects which may cause the dispenser to malfunction. The fuze well, dispenser body, and tail fins must be free from punctures, cracks, or major dents.

c. Tighten loose parts as necessary.

d. Rust, dirt, grit, gummed oil, and water will cause rapid deterioration of dispenser components. Particular care should be taken to keep all exposed unpainted parts clean and free of corrosion.

5-2 STORAGE

a. GENERAL. Because of the area of destructiveness of explosives in the event of accidental ignition or detonation, rigid regulations have been established for the storage of such materials. Packaged items must not be handled roughly, thrown about, tumbled, dropped, or "walked" over other explosives or ammunition.

b. STORAGE CLASSIFICATION. These weapons are in quantity distance class 10, and in storage compatibility group V(1) for the Navy.

c. SECURITY PROTECTION. Due to the security classification of these weapons, they will be stored in a location which can be adequately protected in accordance with security regulations pertaining to the classified material.

d. STORAGE ASHORE. These weapons should be stored in magazines designed, designated, and isolated for the specific purpose of storing ammunition as specified in OP 5. When specially constructed magazines are not available, the building used must afford good protection against moisture and dampness, and have a means for adequate ventilation.

Dispensers in containers may be stacked five high in magazine storage ashore if desired. No dunnage is required for magazine storage ashore.

When shipping and storage containers (empty or with loaded dispensers) are stowed aboard ship (except aircraft carriers), they will be stacked no more than three high with adequate dunnage to restrain the stacks. The container tie-down locations may be used for attachment to the deck.

Dispensers will be stored aboard aircraft carriers in the "bare" condition, i. e., loaded dispensers with the dust and moisture seal protective plugs and tail cone protectors in place but without the containers.

CAUTION: Dispensers must be supported at the hard spots ("CHOCK" markings) only.