



# Afghanistan

## Ordnance Identification Guide

*This guide provides information to facilitate international unexploded ordnance (UXO) awareness and identification. This guide is not intended for use by Explosive Ordnance Disposal (EOD) technicians. Rather, it is designed for other personnel who, of necessity, are trying to identify ordnance in the absence of trained EOD military professionals.*



Prepared By:  
Naval Explosive Ordnance  
Disposal Technology Division

Indian Head, Maryland

**Volume 2 of 2**  
18 August 2004

**DISTRIBUTION STATEMENT A:**  
Approved for public release; distribution is unlimited.

# TABLE OF CONTENTS

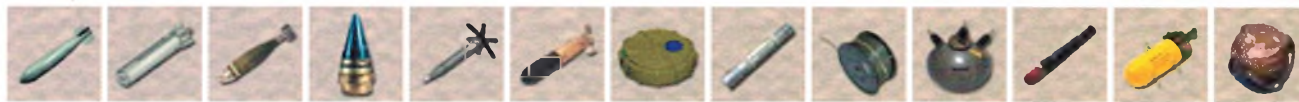

## Introduction

Miscellaneous Information .....	3
Disclaimer/Warning .....	3
Contact Information .....	3

## Language Identification Chart

.....	4
-------	---

## Soviet Ordnance Terms

Transliteration of Russian Alphabet .....	7
Ammunition Filler Codes .....	8
General Ordnance Markings .....	9
Projectile Suffixes .....	10
Soviet Projectile Weight Classifications .....	10
Caliber of using weapons identified by third- component numbers of the model code .....	11
Model Markings for Mines .....	11
Typical Mine Markings .....	12
Typical Bomb Markings .....	12

## Foreign Projectile Terms

Russian .....	13
Arabic .....	16
Chinese .....	22

## Markings

Alphanumeric markings .....	25
Graphic Symbols .....	29
Map of Afghanistan .....	30

## Safety and General Information

Bomb .....	31
Dispenser .....	33

Projectile .....	34
Grenade .....	36
Fuze .....	38
Rocket .....	39
Guided Missile .....	40
Landmine .....	42
Naval Mine .....	45
Depth Charge, Sound Signal & Marker .....	47
Scatterable .....	48

## Ordnance Information

## Pages

### Volume 1

Bombs .....	1 - 25
Dispensers, Clusters & Launchers .....	1 - 20
Projectiles .....	1 - 131

### Volume 2

Fuze/Firing Devices .....	1 - 93
Grenades .....	1 - 12
Rockets .....	1 - 39
Guided Missiles .....	1 - 25
Landmines .....	1 - 40
Pyrotechnics .....	1 - 5
Improvised Explosive Devices .....	1 - 2
Misc Explosive Devices .....	1 - 5
Depth Charge or Other Underwater .....	1 - 1
Scatterable .....	1 - 14

## BELGIAN PROJECTILE FUZE, PD, NR 2117



## BELGIAN PROJECTILE FUZE, PD, NR 2421

Ordnance used with:  
NR 483A1, 106MM, CARTRIDGE, HE-AP, RECOILLESS...  
NR 483A1, 106MM, HE-AP



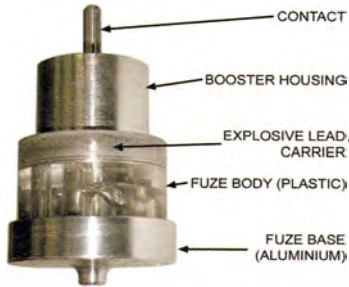

### **BULGARIAN ROCKET FUZE, BASE DETONATING ELEMENT, VP-22 BP**

Ordnance used with:  
PG-7L, 94MM, HEAT  
VP-22, ROCKET, PIBD  
VP-16 G CH, ROCKET, PIBD, POINT INITIATING EL...

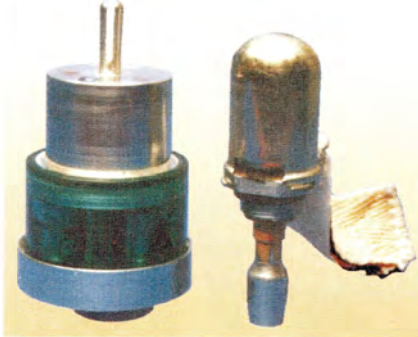

### **BULGARIAN ROCKET FUZE, PIBD, VP-22**

Ordnance used with:  
PG-7L, 94MM, HEAT  
VP-16 G CH, ROCKET, PIBD, POINT INITIATING EL...  
VP-22 BP, FUZE, ROCKET, PIBD, BASE DETONATING...

## **BULGARIAN ROCKET FUZE, POINT-INITIATING ELEMENT, VP-16 G CH**

Ordnance used with:  
PG-16, 58MM, HEAT-T  
PG-7L, 94MM, HEAT  
VP-22, ROCKET, PIBD  
PG 22, 72MM, HEAT  
VP-22 BP, FUZE, ROCKET, PIBD, BASE DETONATING...  
VP-9 D CH, ROCKET, PIBD, BASE DETONATING ELEMENT



---

## **ITALIAN LANDMINE FUZE, ELECTRONIC, MODEL UNKNOWN**

Ordnance used with:  
TCE/6, AT, ELECT.

DIMENSIONS UNKNOWN

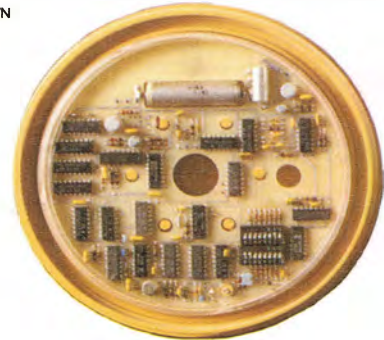

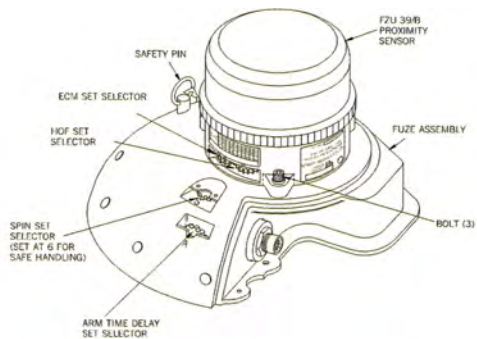

## U.S. DISPENSER FUZE, UNDESIGNATED, MT

Ordnance used with:

SUU-64/B, DISP.

SUU-65/B, DISP.

SUU-66/B, DISP.

CBU-87/B

COMBINED EFFECTS MUNITION

CBU-87A/B

CBU-87B/B

N.E.W. 4.00 G



## U.S. DISPENSER SENSOR, PROXIMITY, FZU-39/B

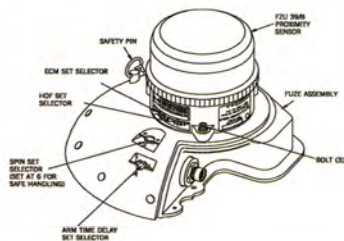

Ordnance used with:

SUU-64/B, DISP.

SUU-65/B, DISP.

SUU-66/B, DISP.

CBU-87/B

COMBINED EFFECTS MUNITION

CBU-87A/B

CBU-87B/B

N.E.W. 5.00 G

## U.S. GUIDED MISSILE WARHEAD ARMING DEVICE, MAU-191/A

Ordnance used with:  
FMU-139A/B, NOSE & TAIL, IMPACT  
AGM-86C, AIR-TO-SURFACE, CALCM  
AGM-86D, CALCM  
UNDESIGNATED, FORWARD SECTION, F/ AGM-86D

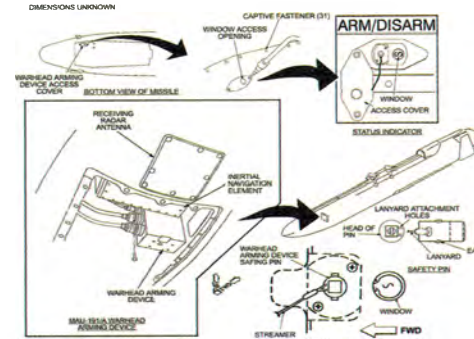

## U.S. PROJECTILE FUZE, GRAZE-SENSITIVE PD, M759

Ordnance used with:  
M789, 30-MM, CARTRIDGE, HEDP  
M799, 30-MM, CARTRIDGE, HEI  
M789, 30-MM, HEDP  
M799, 30-MM, HEI  
UNDESIGNATED, STAB DET. (F/M759)  
UNDESIGNATED, LEAD (310 MG PBXN-5)



N.E.W. 2.00 G



### U.S. PROJECTILE FUZE, PDSQ, FMU-154/B

Ordnance used with:  
PGU-9C/B, CARTRIDGE, 40-MM, HEI  
PGU-9C/B, PROJECTILE, 40-MM, HEI

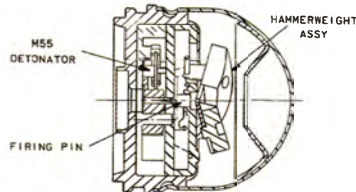

### U.S. PROJECTILE FUZE, PIBD, M550

Ordnance used with:  
M433, 40MM, CARTRIDGE, HEDP  
M433, 40 MM, HEDP  
M55, STAB PRIMER  
XM1060, 40MM, CARTRIDGE, APERS, MULTIPURPOSE ...

N.E.W. 2.00 G

## U.S.S.R. BOMB FIN ASSEMBLY, AVU-551

Ordnance used with:  
FAB-500 SHN, GENERAL PURPOSE, 500 KG

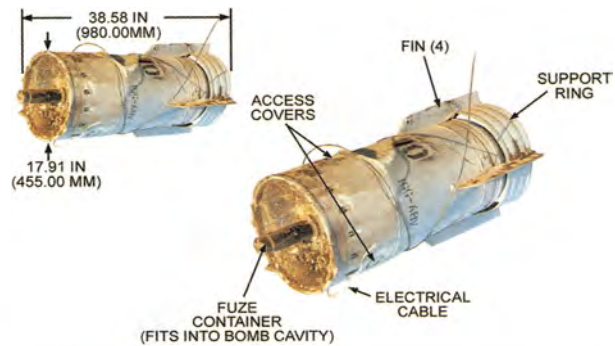

## U.S.S.R. BOMB FUZE, AMV-AE

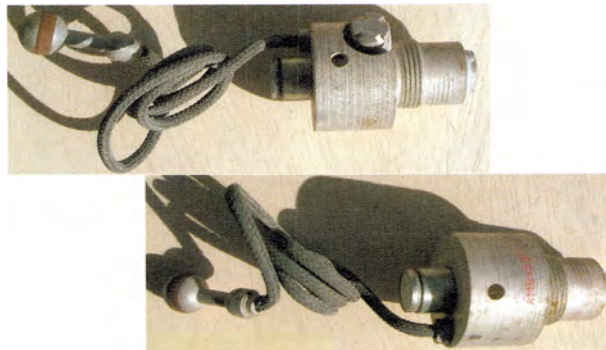

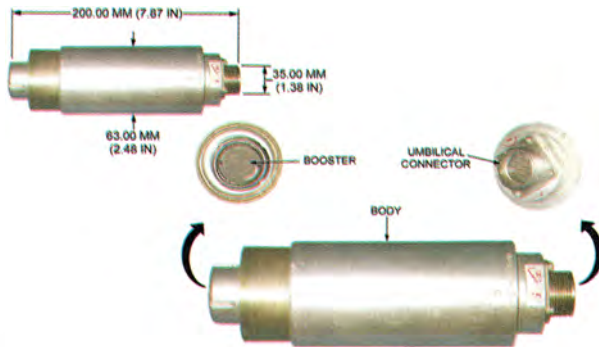

**U.S.S.R. BOMB FUZE, TAIL, IMPACT/SELF  
DESTRUCT, AV-551**

**DIMENSIONS UNKNOWN**



**U.S.S.R. BOMB IGNITER, FIRE BOMB, PFK-ZB 250SH**

Ordnance used with:  
 AVU-ETM, BOMB FUZE  
 PFK ZAB-500-400, INCENDIARY  
 PK.K ZAB-500-400, INCENDIARY  
 ZAB-500-400, BOMB, INCENDIARY  
 ZAB-250SH, INCENDIARY

## U.S.S.R. LANDMINE FUZE, AT, PRESSURE, MVCH-62

Ordnance used with:  
TM-62B, AT, PAPER-COATED  
TM-62D, AT, WOOD  
TM-62M, AT  
TM-62P, AT, PLASTIC  
TM-62P2, AT, PLASTIC  
TM-62P3, AT, PLASTIC



## U.S.S.R. LANDMINE FUZE, AT, TILTROD, MVSH 57 WITH TM-57 LANDMINE

Ordnance used with:  
TM-57, AT





### U.S.S.R. LANDMINE FUZE, PRESSURE, AT, MVZ-57

Ordnance used with:  
TM-57, AT

N.E.W. 2.00 G

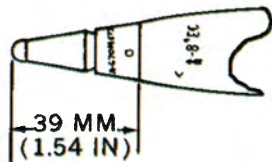

### U.S.S.R. PROJECTILE FUZE, PD, A-670M

Ordnance used with:  
FT, 30-MM, HE-T  
OR-84, 30MM, HE-T  
OT, 30-MM, HE-T  
OT-30, 30-MM, HE-T  
JOSV, 30 MM, HEIT  
OFZ, 30MM X 165MM, CARTRIDGE, HEI  
UOF-84, 30MM X 165MM, CARTRIDGE, HEI

## U.S.S.R. PROJECTILE FUZE, PD, B-23A

Ordnance used with:

OFZ, 23MM, HEI

OFZT, 23-MM, CARTRIDGE, HEI-T

OFZT, 23MM X 115MM, CARTRIDGE, HEI-T

OFZT, 23-MM, HEI-T



N.E.W. 2.00 G

## U.S.S.R. PROJECTILE FUZE, PD, VMG

Ordnance used with:

VOG-26, 30-MM, CARTRIDGE, FRAG

7P9M, CARTRIDGE, 30MM, FRAG

VOG-17M, CARTRIDGE, 30MM, FRAG

VOG-26, 30-MM, FRAGMENTATION

7P9M, 30-MM, FRAGMENTATION

VOG-17M, 30-MM, FRAGMENTATION

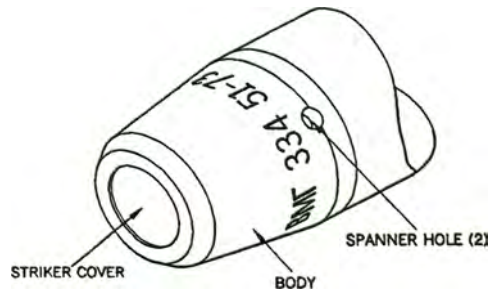



### **U.S.S.R. PROJECTILE FUZE, PDS, V-19U**

Ordnance used with:  
OFZ, CARTRIDGE, 23-MM, HEI, (23MM X 152MM)  
OFZ, 23-MM, HEI

N.E.W. 6.00 G

---



### **U.S.S.R. PROJECTILE FUZE, PDS, V19UK**

Ordnance used with:  
OFZ, CARTRIDGE, 23-MM, HEI, (23MM X 152MM)  
OFZ, 23-MM, HEI

N.E.W. 6.00 G

---

## U.S.S.R. PROJECTILE FUZE, PDSD, VMG-M

Ordnance used with:  
VOG-26, 30-MM, CARTRIDGE, FRAG  
VOG-25, 40MM, FRAG  
7P9M, CARTRIDGE, 30MM, FRAG  
VOG-17M, CARTRIDGE, 30MM, FRAG  
VOG-26, 30-MM, FRAGMENTATION  
7P9M, 30-MM, FRAGMENTATION

N.E.W. 1.00 G

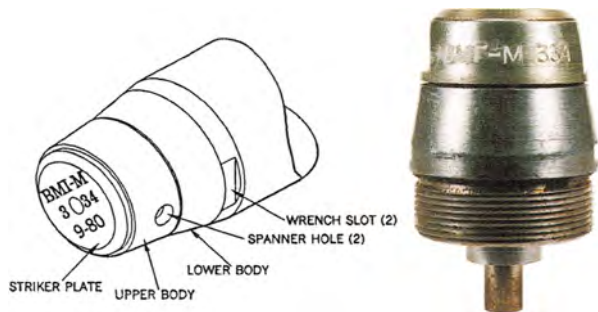

## U.S.S.R. PROJECTILE FUZE, PIBD, VP-9

Ordnance used with:  
PG-9S, 73-MM, HEAT-T  
PG-9, 73-MM, HEAT-T

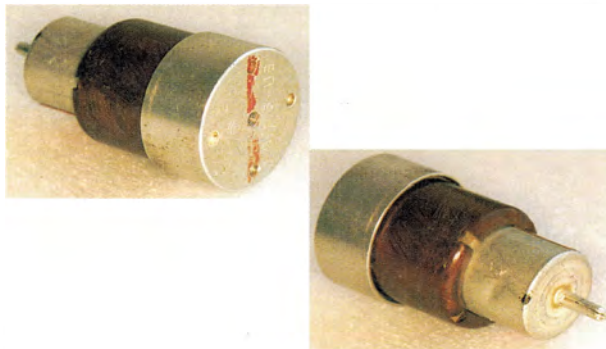



**YUGOSLAV LANDMINE FUZE, APERS, PRESSURE, UPMAH-1**

Ordnance used with:  
PMA-1, APERS  
PMA-1A, APERS

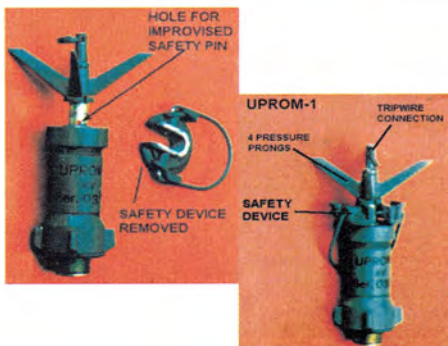

**YUGOSLAV LANDMINE FUZE, APERS, PRESSURE/PULL, UPROM-1**

Ordnance used with:  
PROM-1, APERS, BOUNDING  
PPMP-2, LANDMINE, APERS, STAKE

## U.S.S.R. FIRING DEVICE, PULL/PRESSURE, MUV-2

Ordnance used with:

UNKNOWN, APERS, CYLINDRICAL

MON-100, APERS, DIRECTIONAL

MON-200, APERS, DIRECTIONAL

MON-50, APERS, CLAYMORE

MON-90, APERS, CLAYMORE



MUV-2 FITTED WITH A PERCUSSION DETONATOR ASSEMBLY

## U.S.S.R. LANDMINE FUZE, PULL, MUV

Ordnance used with:

UNKNOWN, APERS, CYLINDRICAL

MON-100, APERS, DIRECTIONAL

MON-200, APERS, DIRECTIONAL

MON-50, APERS, CLAYMORE

MON-90, APERS, CLAYMORE

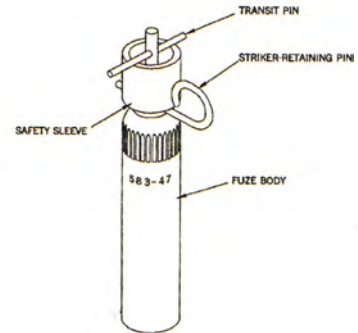

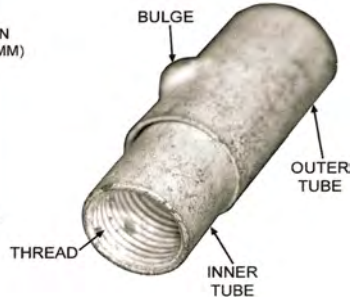
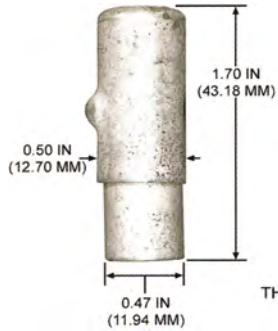

### YUGOSLAV LANDMINE FUZE, PRESSURE, MV-5

Ordnance used with:  
TMD-1, ANTITANK, WOOD  
MKTBT, AT

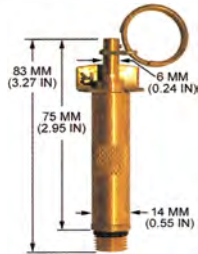

### IRANIAN LANDMINE FUZE, PRESSURE, MODEL UNKNOWN (NO. 4, PEDAL)

Ordnance used with:  
NO 4, APERS, PLASTIC (PEDAL)

**COUNTRY UNKNOWN FIRING DEVICE, PULL, BRASS, MODEL UNKNOWN**

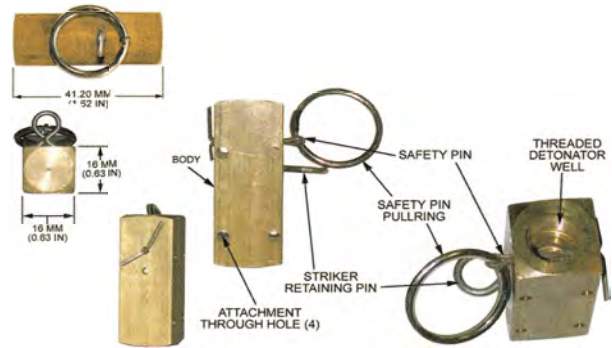

**U.S.S.R. BOMB FUZE ARMING DELAY MECHANISM, MDV-2**

Ordnance used with:  
UNKNOWN, 100KG, HIGH-DRAG  
AM-A, BOMB, NOSE  
AM A B/V, BOMB, NOSE  
AM B, BOMB, NOSE



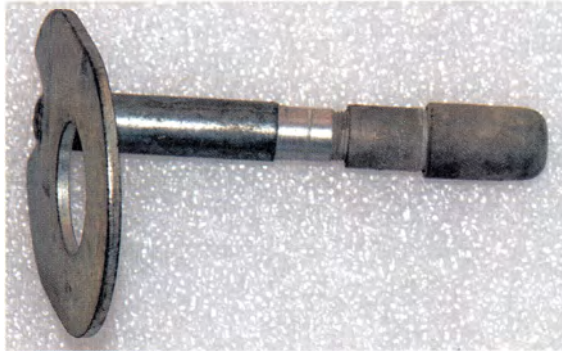

## U.S.S.R. BOMB FUZE ARMING DELAY MECHANISM, MDV-4

Ordnance used with:  
 UNKNOWN, 100KG, HIGH-DRAG  
 AGDT B, BOMB, NOSE  
 TM-24A, BOMB, NOSE OR TAIL  
 TM-24B, BOMB, NOSE OR TAIL, MT  
 UNKNOWN, RUNWAY PENETRATION, 50 KG, (DIBBER)

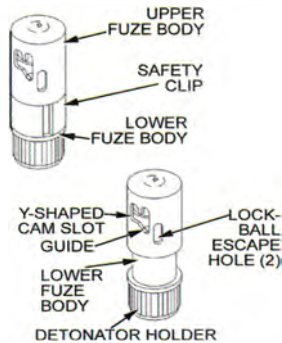
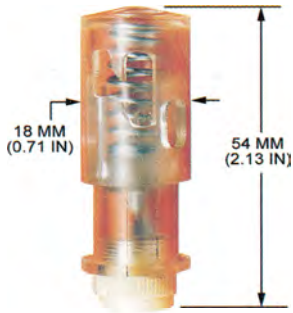

## IRANIAN LANDMINE FUZE, AT, PRESSURE, MODEL UNKNOWN

Ordnance used with:  
 YM III, ANTI TANK  
 YM-3, ANTITANK

## U.S.S.R., BULGARIAN, AND POLISH GRENADE FUZES, STRIKER-RELEASE, UZRG, UZRGM, UZRGM-2

Ordnance used with:

F-1, HAND, FRAG

TIP F-1, HAND, FRAG

RG-42, HAND, FRAG

MDL 59, HAND, FRAG

RGD-5, HAND, FRAG

UNKNOWN, HAND, HE-FRAG, MINI

F-1, HAND, FRAG

N.E.W. 2.10 G

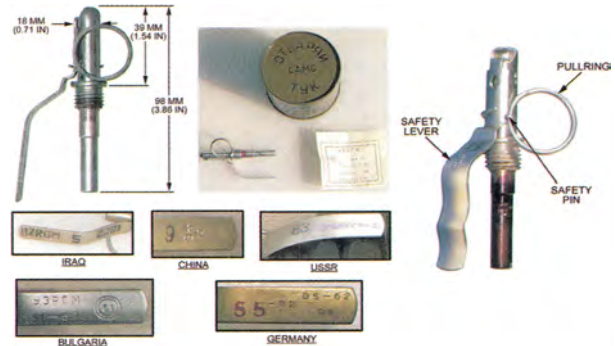

## YUGOSLAV LANDMINE FUZE, PRESSURE, UANU-1

Ordnance used with:

TMA-1A, AT

TMA-2, AT

TMA-5, AT

TMA-5A, AT

TM-100, APERS

TM-200, APERS

TM-500, APERS

N.E.W. 2.20 G

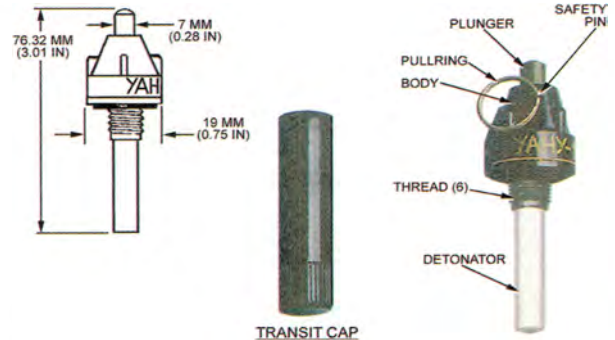

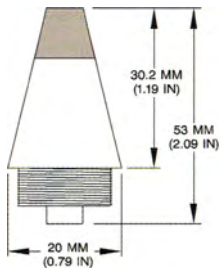

## BULGARIAN PROJECTILE FUZE, PDSD, MG-25

Ordnance used with:  
 OFZT, 23MM, HEI-T  
 OFZT, CARTRIDGE, 23MM, HEI-T

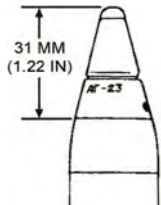

## U.S.S.R. PROJECTILE FUZE, PD, AG-23

Ordnance used with:  
 OFZ, CARTRIDGE, 23-MM, HEI (23MM X 115MM)  
 OFZ, 23-MM, FRAG-HEI

## U.S.S.R. PROJECTILE FUZE, PDSD, MG-25

Ordnance used with:  
OFZT, CARTRIDGE, 23MM X 152MM, FRAG-HEIT  
OFZT, 23MM, FRAG-HEIT  
OFZT, 23-MM, HEI-T

N.E.W. 6.00 G

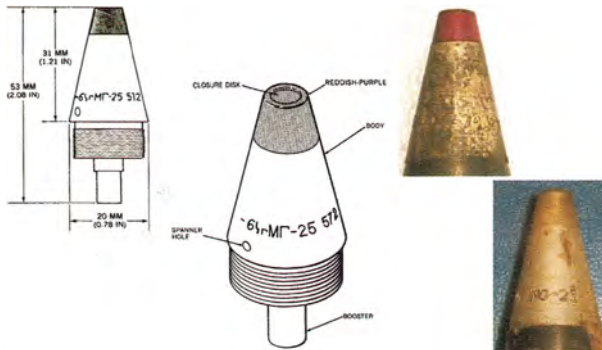

## BULGARIAN FUZE, VP-9, ROCKET, PIBD (VP-9 G CH AND VP-9 D CH)

Ordnance used with:  
PG-15, CARTRIDGE, 73-MM, HEAT-T  
PG-15V, CARTRIDGE, 73MM, HEAT  
PG-9, 73MM, HEAT  
PG-15VN, CARTRIDGE, 73MM, HEAT  
PG-9N, 73MM, HEAT  
PG-9V, 73MM, CARTRIDGE, ROCKET, HEAT  
PG-9VN, 73MM, CARTRIDGE, ROCKET, HEAT

N.E.W. 2.51 G



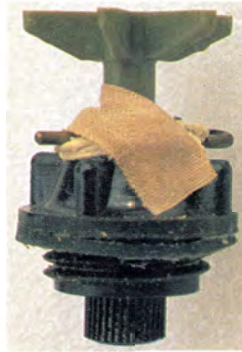

## YUGOSLAV LANDMINE FUZE, APERS, PRESSURE, UPMAH-2

Ordnance used with:  
PMA-2, APERS

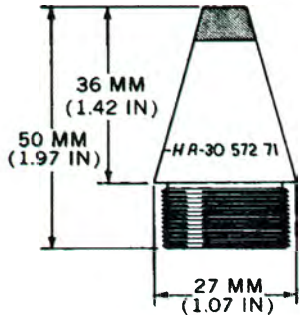

## U.S.S.R. PROJECTILE FUZE, PD, A-30

Ordnance used with:  
OFZ, 30-MM, HEI  
OFZ, 30-MM, CARTRIDGE, HEI

N.E.W. 2.00 G

## RUSSIAN PROJECTILE FUZE, BD, BD-30

Ordnance used with:

OFT, CARTRIDGE, 30-MM, APHEI (EARLY)

OFT, 30MM, APHEI (EARLY)

BR-30, 30-MM, APHE



N.E.W. 16.00 G

## CHINESE PROJECTILE FUZE, BD, TYPE 4

Ordnance used with:

DK 82, CARTRIDGE, 82MM, HEAT

TYPE 65

TYPE 56, 80MM, HEAT, (VARIANT 3)

TYPE 56, 80MM, HEAT, MODIFIED

PG-2, 80MM, HEAT

TYPE 56, 80MM, HEAT



N.E.W. 11.00 G



### **RUSSIAN PROJECTILE FUZE, BD, BDM-30**

Ordnance used with:  
BR-30, TYPE II, 30-MM, APHEI  
OFT, 30MM, APHEI (CURRENT)  
OFT, CARTRIDGE, 30-MM, APHEI (CURRENT)

N.E.W. 26.00 G

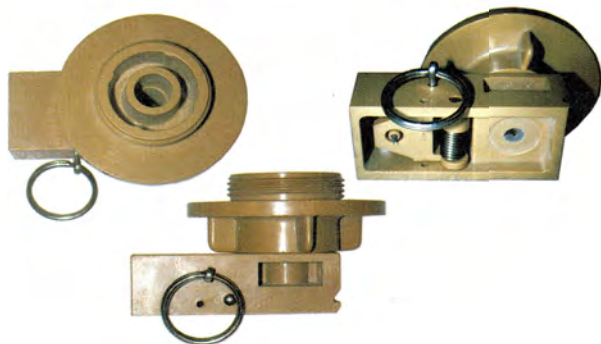

### **ITALIAN LANDMINE FIRING DEVICE, ANTILIFT, MODEL UNKNOWN**

Ordnance used with:  
TC-6, AT  
TC/6

## U.S.S.R. PROJECTILE FUZE, PDSD, B-37

Ordnance used with:

OR-167, 37-MM, FRAG-T

OR-167N, 37-MM, FRAG-T

UOR-167, 37-MM, CARTRIDGE, FRAG-T

UOR-167N, 37-MM X 253RMM, CARTRIDGE, FRAG-T

UOR-167N, 37-MM, CARTRIDGE, FRAG-T

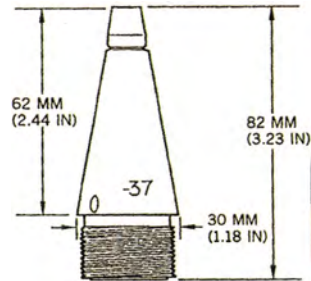

N.E.W. 5.00 G

## U.S.S.R. BOMB FUZE, NOSE, AM-A

Ordnance used with:

OFAB 100NV, BOMB, FRAG, 100 KG

AO 1 SCH, BOMB, HE

AO-1SCH

AOKH-10, BOMB, FRAGMENTATION/CHEMICAL

AOKH-8, BOMB, FRAGMENTATION/CHEMICAL

KHAB-100, BOMB, CHEMICAL

P 50 75, BOMB, PRACTICE

N.E.W. 7.00 G

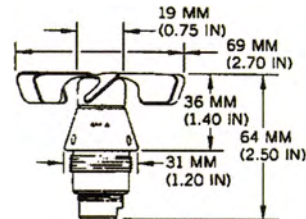

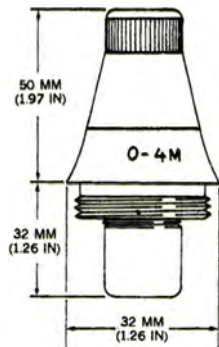

## BULGARIAN PROJECTILE FUZE, PD, O-4M

Ordnance used with:

- OG-7V, 40MM, CARTRIDGE, FRAG
- OG-7VM, 40MM, CARTRIDGE, FRAG
- OG-9, 73-MM, HE-FRAG
- OG-9BG, 73MM, HERA
- OG-9G
- OG-9M, PROJECTILE, 73MM, FRAGMENTATION
- OG-9B, 73MM, HE-FRAG

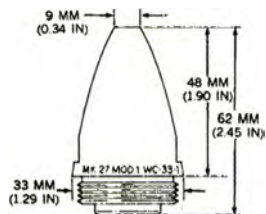

## U.S. PROJECTILE FUZES, PD, MK 27 MODS 0 & 1

Ordnance used with:

- MK 1 MOD 1, 40-MM, HE-SD, AA
- MK 1 MOD 10, 40-MM, HE-SD, AA
- MK 1 MOD 11, 40-MM, HE-SD, AA
- MK 1 MOD 12, 40-MM, HE-SD, AA
- MK 1 MOD 13, 40-MM, HE-SD, AA
- MK 1 MOD 14, 40-MM, HE-SD, AA
- MK 1 MOD 15, 40-MM, HE-SD, AA

N.E.W. 6.00 G

## U.S.S.R. PROJECTILE FUZE, BD, MD-10

Ordnance used with:

BR-471B, 122-MM, APHE-T

BZR-271, 57-MM, APHEI-T

UBR-270, CARTRIDGE, 57-MM, APHE-T

UBR-271, CARTRIDGE, 57-MM, APHE-T

UBR-271K, 57-MM, CARTRIDGE, APHE-T

UBR-281, 57-MM, CARTRIDGE, APHE-T (57MM X 348MM)

UBR-281U, 57-MM, CART., APHE-T (57MM X 348MM)

N.E.W. 13.00 G



## U.K. FIRING DEVICE, SWITCH, PRESSURE, NO. 5 MK 1

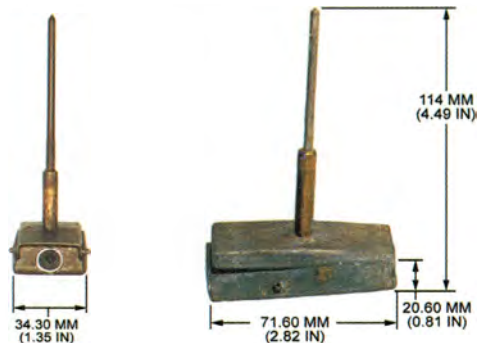

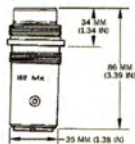

## U.K. PROJECTILE FUZE, PD, NO. 162 MK 10

Ordnance used with:

L10A2, 81-MM, MORTAR, HE  
 L15A1, 81MM, HE, MORTAR  
 L15A3, 81MM, HE, MORTAR  
 L15A4, 81MM, HE, MORTAR  
 L19A1, 81 MM, SMOKE WP, MORTAR  
 MK 7, 3-INCH, HE, MORTAR  
 MK 7, 3-INCH, SMOKE, MORTAR

N.E.W. 36.00 G

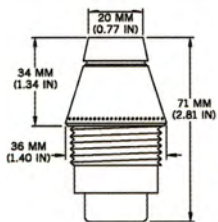

## CHINESE PROJECTILE FUZE, PD, MP-1 (TYPE 1)

Ordnance used with:

TYPE 60-1, 60-MM, SMOKE WP  
 TYPE 63-1, TYPE 60-1, 60-MM, MORTAR, SMOKE, WP  
 TYPE 60-2, 60-MM, HE, MORTAR  
 TH521, 82-MM, HE  
 TYPE 53, 82-MM, HE  
 TYPE 53, 82 MM, SMOKE, WP  
 TYPE 63, 60 MM, HE

N.E.W. 9.00 G

## CHINESE PROJECTILE FUZE, PD, MP-1A

Ordnance used with:

TYPE 60-1, 60-MM, SMOKE WP

TYPE 63-1, TYPE 60-1, 60-MM, MORTAR, SMOKE, WP

TYPE 60-2, 60-MM, HE, MORTAR

TH521, 82-MM, HE

TYPE 53, 82-MM, HE

TYPE 53, 82 MM, SMOKE, WP

TYPE 63, 60 MM, HE

N.E.W. 9.00 G

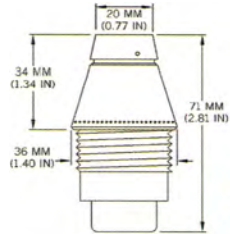

## CHINESE PROJECTILE FUZE, PD, MP-1B

Ordnance used with:

TYPE 60-1, 60-MM, SMOKE WP

TYPE 63-1, TYPE 60-1, 60-MM, MORTAR, SMOKE, WP

TYPE 60-2, 60-MM, HE, MORTAR

TH521, 82-MM, HE

TYPE 53, 82-MM, HE

TYPE 53, 82 MM, SMOKE, WP

TYPE 63, 60 MM, HE

N.E.W. 9.00 G

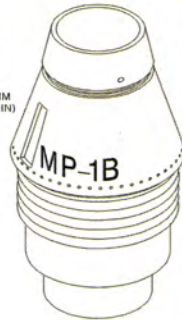
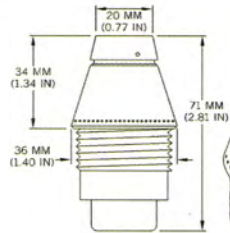

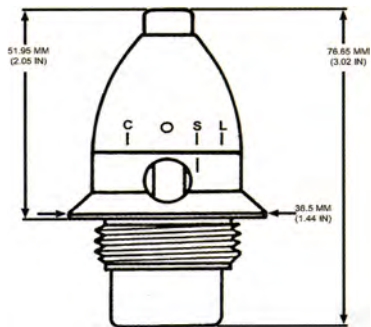

**FRENCH PROJECTILE FUZE, PD, SC 14E**

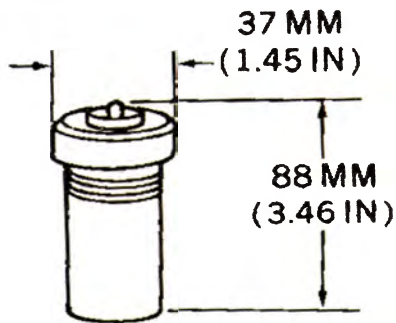

**U.K. LANDMINE FUZE, AT, PRESSURE, NO. 3 MK 1**

Ordnance used with:

- GS MK IV, AT
- MK 4, G.S., ANTITANK MINE
- MK IV, G.S. ANTITANK
- GS MK V, AT
- MK 5, G.S., ANTITANK
- GS MK V HC, AT
- GS MK VC, AT

## CHINESE PROJECTILE FUZE, PD, MM-6

Ordnance used with:  
UNKNOWN, 82 MM, MORTAR, HE  
SAEGHEH, 40MM, HE  
TYPE 42-832, 82MM, HE, MORTAR  
SAEGHEH, CARTRIDGE, 40MM, HE



N.E.W. 8.37 G

## CHINESE PROJECTILE FUZE, PD, MODEL-2



N.E.W. 6.80 G

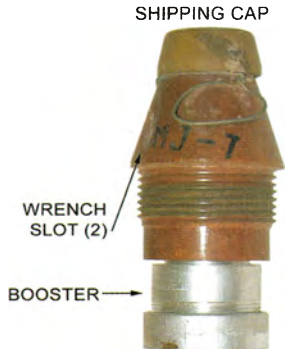

## CHINESE ROCKET FUZE, PI, MJ-7

Ordnance used with:  
 DZGI-40, 75MM, APERS, BOUNDING  
 TYPE 69, 75 MM, APERS, BOUNDING

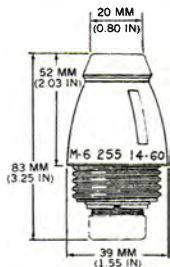

## U.S.S.R. PROJECTILE FUZE, PD, M-6

Ordnance used with:  
 M30, 82MM, MORTAR, HE  
 O-832DU, 82-MM, FRAG  
 O-832D, 82-MM, MORTAR, FRAG  
 D-832, 82-MM, MORTAR, SMOKE, WP  
 D-832DU, 82-MM, MORTAR, SMOKE, WP  
 O-832, 82-MM, FRAG  
 UNKNOWN, 75 MM, HE  
 N.E.W. 8.00 G

## BULGARIAN PROJECTILE FUZE, PD, RGM-2

Ordnance used with:  
FE-462, 122 MM, HE, FRAG  
FE-462, 122MM, HE



## BULGARIAN PROJECTILE FUZE, PDSD, VUBS-1M

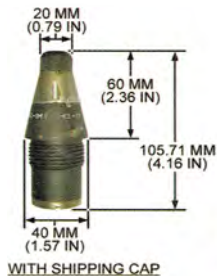

N.E.W. 12.50 G



**BULGARIAN ROCKET FUZE, PD, V-5K**



**CHINESE PROJECTILE FUZE, PD, M-12**

Ordnance used with:

TYPE 843, 120-MM, HE

TYPE 843B, 120 MM, HE

TYPE 55, 120-MM, HE

TYPE 71, 100MM, HE, MORTAR

NASR, 81-MM, HE, A-TO-S OR S-TO-S

NASSAR 81, 81-MM, HE, A-TO-S OR S-TO-S

NASSER 81, 81-MM, HE, A-TO-S OR S-TO-S

N.E.W. 30.00 G

## CHINESE PROJECTILE FUZE, PD, M-6

Ordnance used with:

OG-7V, 40MM, CARTRIDGE, FRAG

OG-7VM, 40MM, CARTRIDGE, FRAG

TYPE 53, 82 MM, SMOKE, WP

UNKNOWN, 75 MM, HE

UNKNOWN, 82 MM, MORTAR, HE

MDL. UNKNOWN, 60MM, MORTAR, HE

UNKNOWN, 60MM, CARTRIDGE, MORTAR, HE

N.E.W. 8.00 G

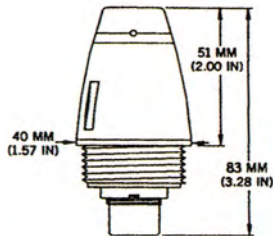

## CHINESE PROJECTILE FUZE, PD, ML-4A

Ordnance used with:

TYPE 54, 122-MM, HE

TYPE 83, 122MM, HE-FRAG, BB

TYPE 83, 122MM, HE-FRAG, HB

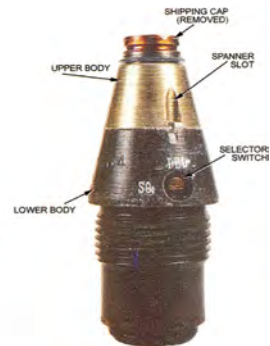

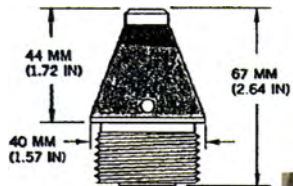

## CHINESE PROJECTILE FUZE, PD, MODEL ML-2

Ordnance used with:  
 TYPE 59, 57MM, CARTRIDGE, HE  
 TYPE 59, 57MM, HE

N.E.W. 8.00 G

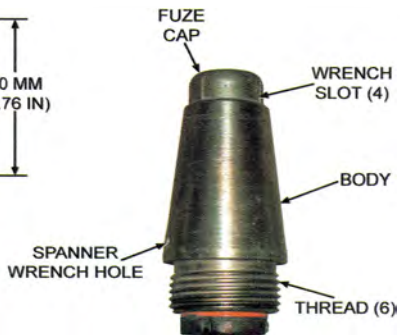
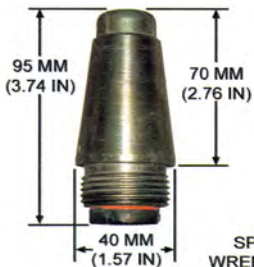

## CHINESE PROJECTILE FUZE, PD, TYPE 2

Ordnance used with:  
 MDL. 64, 82-MM, HE-FRAG  
 TYPE 64, 82MM, HE-FRAG

N.E.W. 19.00 G

## CHINESE PROJECTILE FUZE, PD, TYPE 429

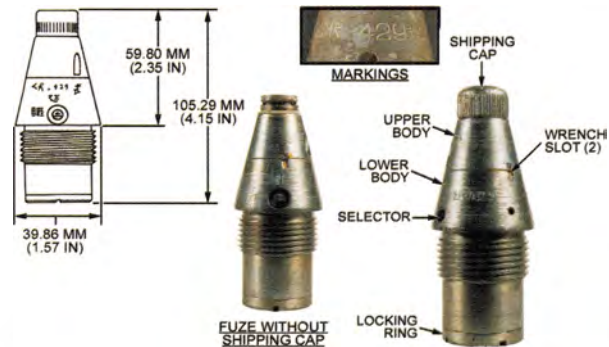

N.E.W. 12.00 G

## CHINESE ROCKET FUZE, PD, MJ-1

Ordnance used with:

TYPE 63-2, 107MM, HE, GROUND

TYPE 63-II, 107MM, HE

TYPE 82, 130MM, HE

TYPE 63, 130 MM, SP

TYPE 82, 130 MM, HEI

TYPE 63-1, WARHEAD, 107 MM, INCENDIARY

TYPE 63-1, 107-MM, INCENDIARY, WP

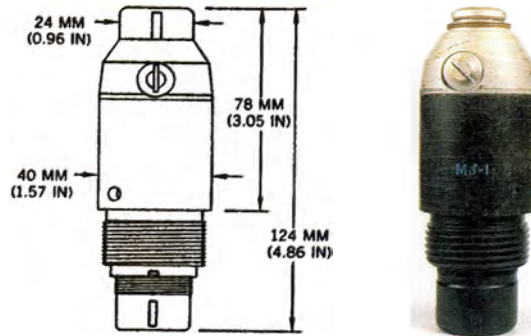

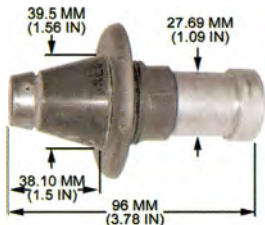

## CHINESE ROCKET FUZE, PI, DREOI

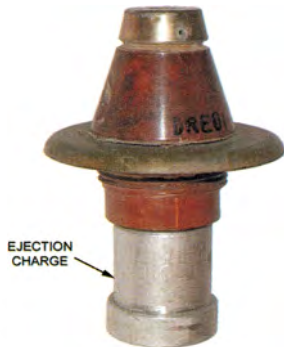

Ordnance used with:  
DZGI-40, 75MM, APERS, BOUNDING  
TYPE 69, 75 MM, APERS, BOUNDING

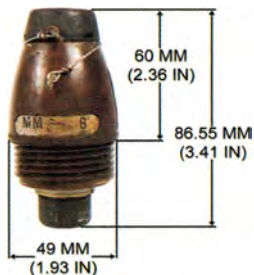

## IRANIAN PROJECTILE FUZE, PD, MM-6



Ordnance used with:  
SAEGHEH, 40MM, HE  
MDL. UNKNOWN, 60MM, MORTAR, HE  
SAEGHEH, CARTRIDGE, 40MM, HE  
UNKNOWN, 60MM, CARTRIDGE, MORTAR, HE

N.E.W. 8.30 G

## NORTH KOREAN PROJECTILE FUZE, PD, PI-2

Ordnance used with:

O-881, 82 MM, FRAG

O-881, CARTRIDGE, 82MM, FRAGMENTATION

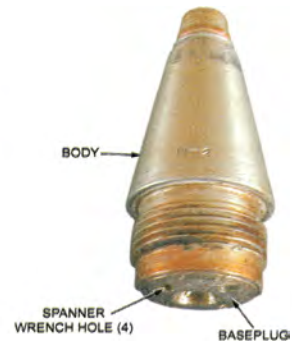

N.E.W. 1.00 G

## U.S.S.R. BOMB FUZE, AMV-AE2

Ordnance used with:

OFAB 100 120, BOMB, FRAG

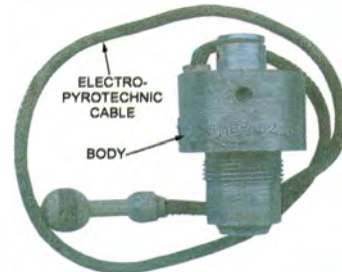
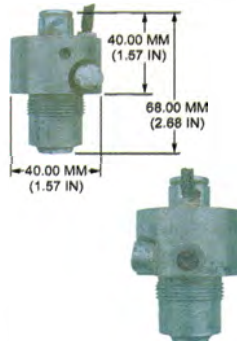

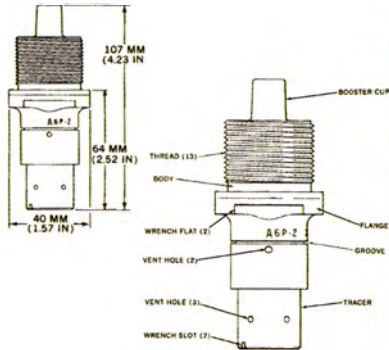

## U.S.S.R. PROJECTILE FUZE, BD, DBR-2

Ordnance used with:

TYPE 367, 85-MM, CARTRIDGE, APHE-T  
 UBR-367, 85-MM, CARTRIDGE, APHE-T  
 BR-367, 85-MM, APHE-T  
 TYPE 367, 85-MM, APHE-T  
 TYPE 376, 85-MM, APHE-T  
 PSV, 100-MM, APHE-T  
 BR 412B, 100-MM, AP-T

N.E.W. 0.00 G

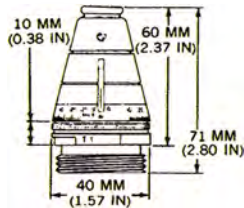

## U.S.S.R. PROJECTILE FUZE, NOSE, (TSQ), T-1

Ordnance used with:

KT-8, 82-MM, MORTAR, ILLUM  
 O-365, 85-MM, PROJECTILE, HE, (2 PIECE)  
 S-832S, 82-MM, ILLUM  
 S-832SM, 82 MM, ILLUM  
 S-843, 120-MM, MORTAR, ILLUMINATION  
 MDL. UNKNOWN, 120-MM, INCENDIARY  
 3D14, 120-MM, MORTAR, SMOKE

N.E.W. 9.00 G

## U.S.S.R. PROJECTILE FUZE, PD, GO-2

Ordnance used with:

OG-7V, 40MM, CARTRIDGE, FRAG  
OG-7VM, 40MM, CARTRIDGE, FRAG  
OG-9, 73-MM, HE-FRAG  
OG-9M, 73-MM, HE-FRAG  
OG-7V, 40MM, FRAG  
OG-7VE, RKT PROPELLED, 85/40 MM, HE  
OFG-7, RKT PROPELLED, 57/40 MM, HE

N.E.W. 8.95 G



## U.S.S.R. PROJECTILE FUZE, PD, GVMZ-7

Ordnance used with:

3100/843  
MDL. 3100-843, 120-MM, SMOKE WP  
F-843, 120-MM, MORTAR, HE  
F-852, 160-MM, MORTAR, HE  
F-853A, 160-MM, MORTAR, HE  
F-853AU, 160-MM, MORTAR, HE  
F 853U, 160-MM, MORTAR, HE

N.E.W. 15.00 G

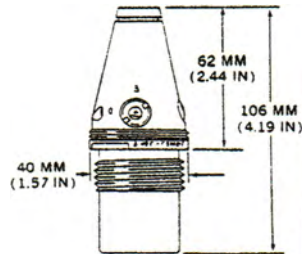

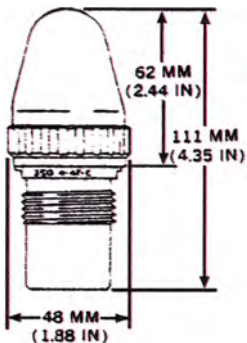

### U.S.S.R. PROJECTILE FUZE, PD, GVMZ-7, WITH SHIPPING COVER

Ordnance used with:

3100/843

MDL. 3100-843, 120-MM, SMOKE WP

F-843, 120-MM, MORTAR, HE

F-852, 160-MM, MORTAR, HE

F-853A, 160-MM, MORTAR, HE

F-853AU, 160-MM, MORTAR, HE

F 853U, 160-MM, MORTAR, HE

N.E.W. 15.00 G

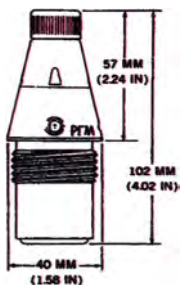

### U.S.S.R. PROJECTILE FUZE, PD, RGM

Ordnance used with:

EF-412

OF-412, 100-MM, FRAG-HE

HE-462, 122MM, HE-FRAG

OF-462, 122-MM, HE-FRAG

0-460A, 122-MM, FRAG

DTS-471, 122-MM, SMOKE

F-412, 100-MM, FRAG-HE

N.E.W. 16.00 G

## U.S.S.R. PROJECTILE FUZE, PD, RGM-2

Ordnance used with:

EF-412

OF-412, 100-MM, FRAG-HE

HE-462, 122MM, HE-FRAG

OF-462, 122-MM, HE-FRAG

O-460A, 122-MM, FRAG

MDL. UNKNOWN, 122-MM, CHEMICAL (NON-PERSISTANT)

D-4, 122-MM, SMOKE, WP

N.E.W. 16.00 G

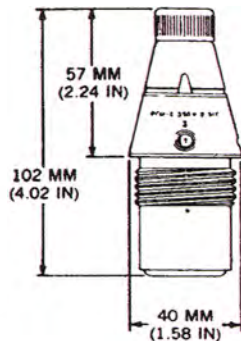

## U.S.S.R. PROJECTILE FUZE, PD, RGM-2M

Ordnance used with:

HE-462, 122MM, HE-FRAG

OF-462, 122-MM, HE-FRAG

OF25, 152-MM, FRAG-HE

OF-56, 122-MM, FRAG-HE

OF-56, 122-MM, HE

OF-56-1, 122-MM, HE



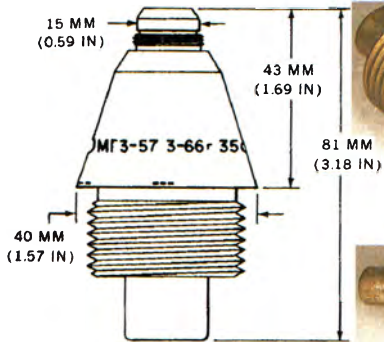

### U.S.S.R. PROJECTILE FUZE, PDSD, MGZ-57

Ordnance used with:  
 OR-281, 57-MM, FRAG-T  
 OR-281U, 57-MM, FRAG-T  
 UOR-281U, CARTRIDGE, 57MM X 348MM, FRAG-T  
 UOR-281, CARTRIDGE, 57MM X 348MM, FRAG-T

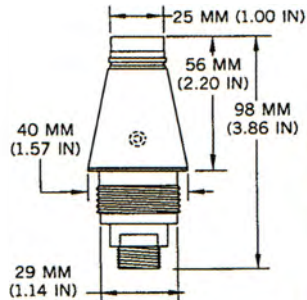

### U.S.S.R. PROJECTILE FUZE, PIBD, GPV-2

Ordnance used with:  
 BK-2M, 85-MM, HEAT-FS  
 BK-354M, 76-MM, HEAT-FS  
 BK-4M, 115-MM, HEAT-FS  
 BK-6M, 122-MM, HEAT-FS  
 BK463UM, 122-MM, HEAT-FS  
 UBK-4M, CARTRIDGE, 100-MM, HEAT-FS  
 HXG, 100-MM, HEAT-T  
 N.E.W. 5.00 G

## U.S.S.R. PROJECTILE FUZE, TSQ, D-1-U

Ordnance used with:

OF-18, 115-MM, HE-FRAG  
3OF26, 125-MM, FRAG-HE  
OF-26, 125-MM, FRAG-HE  
OF-540, 152-MM, FRAG-HE  
OF540, 15-MM, FRAG-HE  
OF-56, 122-MM, FRAG-HE  
OF-56, 122-MM, HE

N.E.W. 17.00 G

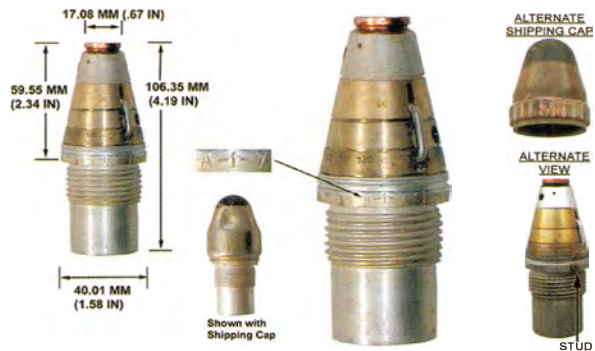

## U.S.S.R. PROJECTILE FUZES, PD, KTM-1, KTM-1U, KTM-2, KTM-3, KTMZ-1, KTMZ-1U AND KTMZ-2

Ordnance used with:

MDL. OF, 85-MM, HE-FRAG  
O-240, 45-MM, HE-FRAG  
O-271, 57-MM, FRAG  
O-271-U, 57-MM, FRAG  
O-350A, 76-MM, FRAG  
O-365, 85-MM, PROJECTILE, HE, (2 PIECE)  
O-365K, 85-MM, FRAG

N.E.W. 9.00 G

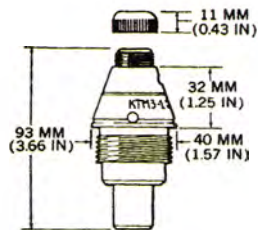

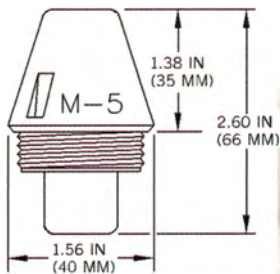

## U.S.S.R. PROJECTILE FUZES, PD, M-5 AND M-5M

Ordnance used with:  
 O-832DU, 82-MM, FRAG  
 O-832D, 82-MM, MORTAR, FRAG  
 D-832, 82-MM, MORTAR, SMOKE, WP  
 D-832DU, 82-MM, MORTAR, SMOKE, WP  
 OF-843, 120-MM, MORTAR, FRAG-HE  
 OF-843A, 120-MM, MORTAR, HE-FRAG  
 O-832, 82-MM, FRAG

N.E.W. 11.00 G

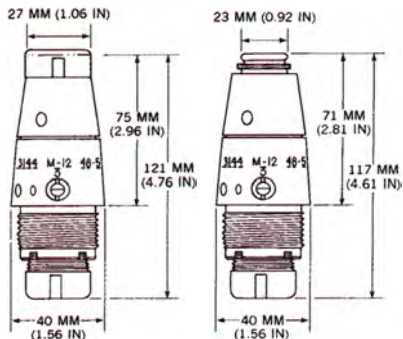

## U.S.S.R. PROJECTILE FUZES, PD, M12 & V-22

Ordnance used with:  
 3100/843  
 MDL. 3100-843, 120-MM, SMOKE WP  
 D-5, 120-MM, MORTAR, SMOKE (WP)  
 F-843, 120-MM, MORTAR, HE  
 OF-843, 120-MM, MORTAR, FRAG-HE  
 OF-843A, 120-MM, MORTAR, HE-FRAG  
 3OF-843B, 120-MM, CARTRIDGE, MORTAR, FRAG-HE

N.E.W. 28.00 G

## U.S.S.R. ROCKET FUZE, NOSE, PD, V-25

Ordnance used with:

F-961, 240 MM, SPIN STABILIZED, HE, S-TO-S

F-961U, 240 MM, SPIN STABILIZED, HE, S-TO-S

M-14-OF, 140 MM, HE-FRAG

MDL. UNKNOWN, WHD, 140 MM, CHEMICAL, NON-PERS...

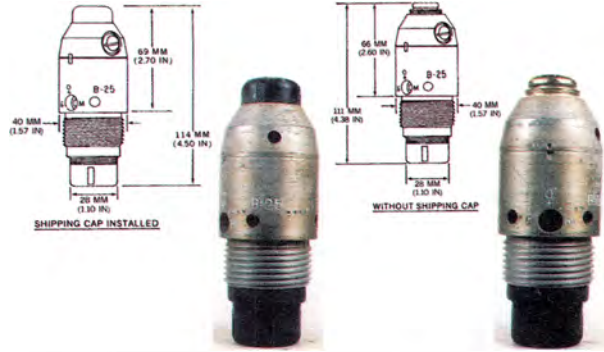

## U.S.S.R. ROCKET FUZE, PD, V-5K

Ordnance used with:

UB-16-57-U, 57-MM, LAUNCHER, RKT

C-5K, 57-MM, HEAT, A-TO-S

S-5K, 57-MM, HEAT, A-TO-S

S-5KO, 57-MM, WARHEAD, HEAT-FRAG, A-TO-S

S-5K1, 57-MM, HEAT, A-TO-S

C-5MO, 57-MM, HE/FRAG, A-TO-S

S-5MO, 57-MM, HE/FRAG, A-TO-S

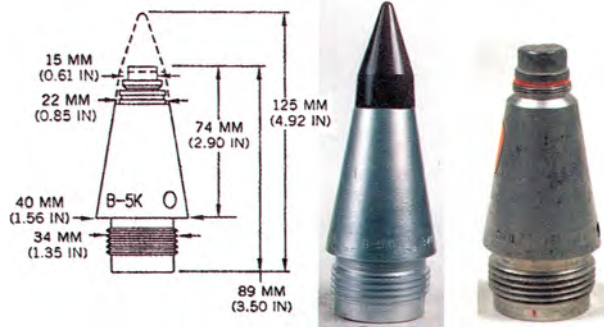



## U.S.S.R. ROCKET FUZE, PD, V-8

Ordnance used with:

S-8-OF, 80-MM, HE/FRAG, A-TO-S

S-8-OF, WARHEAD, 80-MM, HE/FRAG, A-TO-S

S-8-OF, 80-MM, MOTOR, SOLID PROPELLANT, A-TO-S



## U.S.S.R. ROCKET FUZE, PDSD, V-5M1

Ordnance used with:

UB-16-57-U, 57-MM, LAUNCHER, RKT

S-5KO, 57-MM, WARHEAD, HEAT-FRAG, A-TO-S

S-5M, 57-MM, HE, A-TO-S

S-5M1, 57-MM, HE-FRAG, A-TO-S

C-5MO, 57-MM, HE/FRAG, A-TO-S

S-5MO, 57-MM, HE/FRAG, A-TO-S

S-50, ILLUMINATION, A-TO-S

## U.S.S.R. ROCKET FUZE, VB-5

Ordnance used with:

S-5-OB, 57-MM, WARHEAD, ILLUMINATION, A-TO-S

S-5-01, 57-MM, ILLUMINATION, A-TO-S

S-5-OB, 57-MM, ILLUMINATION, A-TO-S

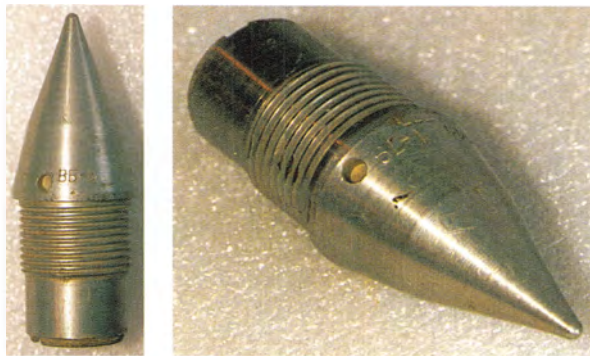

## YUGOSLAV PROJECTILE FUZE, PD, UTU, M78 / AU-29

Ordnance used with:

M62P3, 120-MM, MORTAR, HE

M77, 120-MM, MORTAR, HERA

M62, 120-MM, HE, MORTAR

M95A, 120-MM, MORTAR, HE

M62P5, 120-MM, HE, MORTAR

M95A, 120-MM, MORTAR, CARTRIDGE, HE

M77, 120-MM, CARTRIDGE, MORTAR, HERA, FRAG

N.E.W. 16.00 G

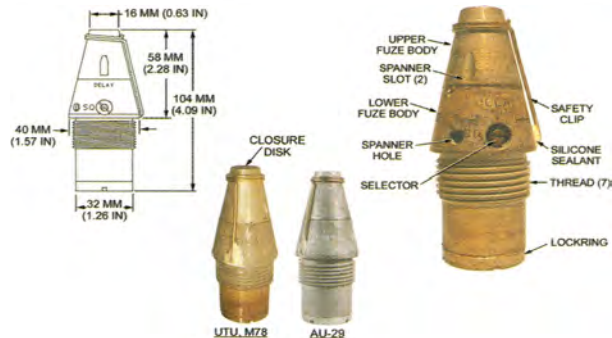

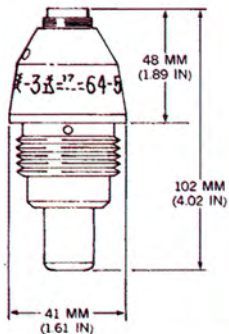

### CHINESE PROJECTILE FUZE, PD, TYPE 1 (ARTILLERY)

Ordnance used with:  
TYPE 26.12, 75MM, HE  
UNKNOWN, 57 MM, HE  
UNKNOWN, 75 MM, HE

N.E.W. 8.00 G

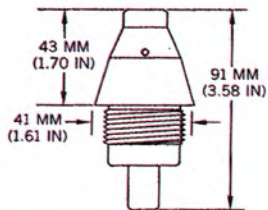

### CHINESE PROJECTILE FUZE, PD, TYPE 53 MODEL 1

Ordnance used with:  
MDL. UNKNOWN, 105 MM, HE  
UNKNOWN, CARTRIDGE, 105MM, HE

N.E.W. 14.00 G

## CHINESE PROJECTILE FUZE, PD, TYPE 53 MODEL 2

Ordnance used with:  
UNKNOWN, 75 MM, HE

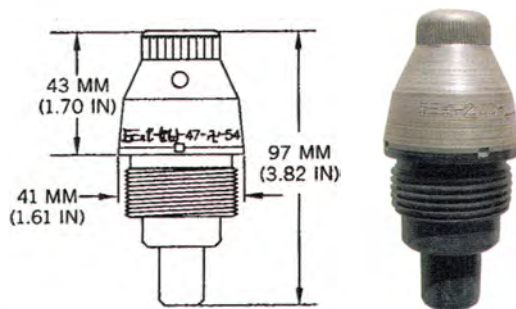

## CHINESE PROJECTILE FUZE, PD, TYPE 6 (M30P-1)

Ordnance used with:  
M30, 82MM, MORTAR, HE  
TYPE 52, 75 MM, HE, RR  
TYPE 52, CARTRIDGE, 75MM, HE  
MDL. UNKNOWN, SHIPPING-STORAGE CONTAINER FOR ...

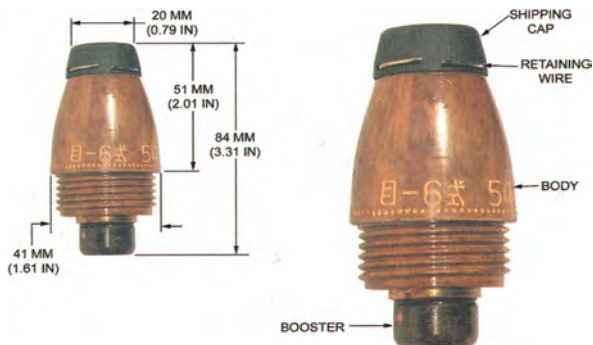

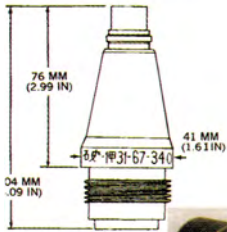

### CHINESE PROJECTILE FUZE, PIBD TYPE 1 (SPECIAL)

Ordnance used with:  
TYPE 52, 75 MM, RR, HEAT

N.E.W. 2.00 G

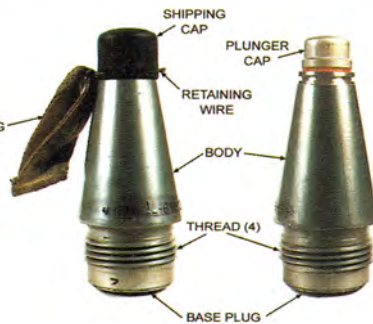

### CHINESE PROJECTILE FUZE, PIBD, TYPE 1

Ordnance used with:  
TYPE 52, 75 MM, RR, HEAT

## U.S.S.R. PROJECTILE FUZE, PD, MG-N

Ordnance used with:  
O-350A, 76-MM, FRAG  
OF-350, 76-MM, HE-FRAG  
OF-350A, 76-MM, HE-FRAG  
OF-350, 76-MM, HE  
M69, 85-MM, HE  
UO-367A, CARTRIDGE, 85MM, FRAG

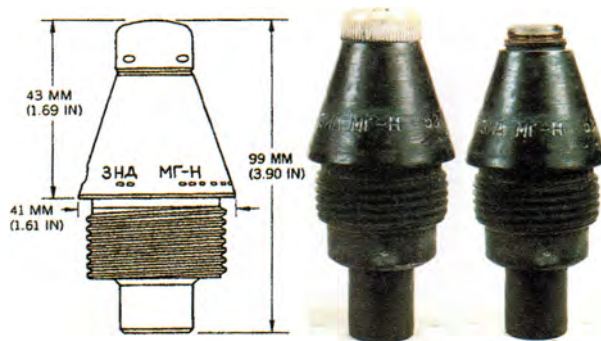

## U.S.S.R. PROJECTILE FUZE, PD, OR PIBD, GK-1

Ordnance used with:  
BK-881, 82-MM, CARTRIDGE, HEAT  
OG-82, 82 MM, FRAG-HE  
PG-82, 82 MM, HEAT  
GK-662, 82 MM, WARHEAD, HEAT  
GO-662, 82 MM, WHD.  
O-881, CARTRIDGE, 82MM, FRAGMENTATION

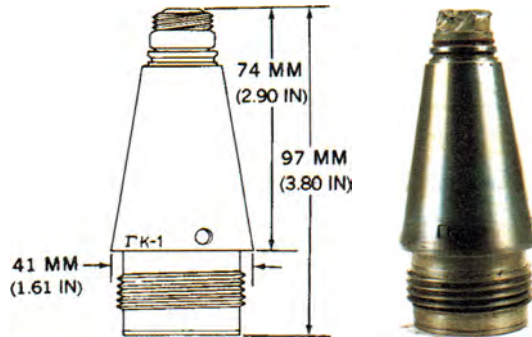

N.E.W. 2.00 G

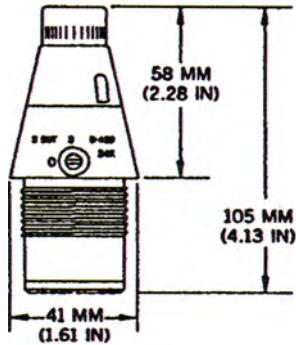

## U.S.S.R. PROJECTILE FUZES, PD, V-429 AND V-429E

Ordnance used with:  
EF-412

OF-412, 100-MM, FRAG-HE

BP-460A, 122-MM, HEAT

MDL. UNKNOWN, 122-MM, CHEMICAL (NON-PERSISTANT)

DTS-1, 130-MM, SMOKE, WP

N.E.W. 16.00 G

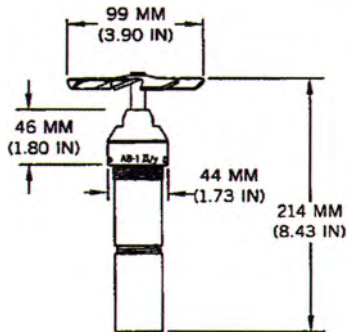

## U.S.S.R. BOMB FUZE, NOSE & TAIL, AV-1 D/U

Ordnance used with:

UNKNOWN, 100KG, HIGH-DRAG

MDL. 518, 452MM, HE

FAB-250 M46, BOMB, GENERAL PURPOSE

FAB-250 M54, BOMB, GENERAL PURPOSE

N.E.W. 52.00 G

## YUGOSLAV PROJECTILE FUZE, PD, UT M68 P1

Ordnance used with:

M73, 60-MM, HE, MORTAR

TRM73, 60-MM, HE, MORTAR

M72, 81-MM, HE, MORTAR

M73, 60-MM, SMOKE, MORTAR

M73, 60MM, CARTRIDGE, SMOKE, MORTAR

M62P3, 120-MM, MORTAR, HE

M74A1, 82-MM, MORTAR, HE

N.E.W. 23.45 G

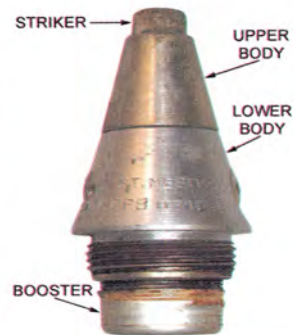

## AUSTRIAN PROJECTILE FUZE, PD, M52B1

Ordnance used with:

HE 83 LD

HE 83, 82-MM, MORTAR, HE

HE83 LD, 82MM, HE

HE 83 LD, CARTRIDGE, 82MM, HE

N.E.W. 17.42 G

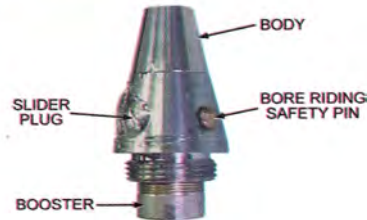
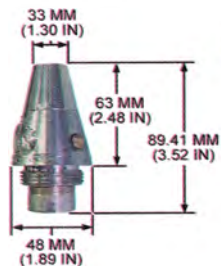

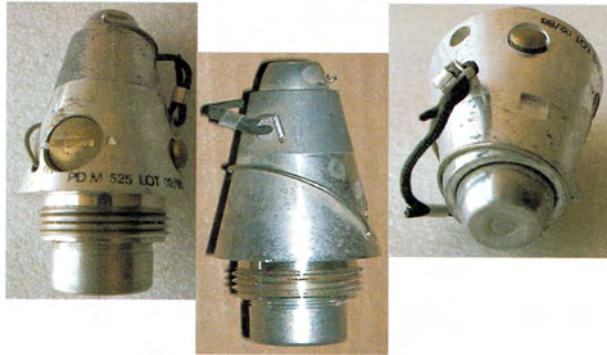

## AUSTRIAN PROJECTILE FUZE, PD, PDM525

Ordnance used with:  
 NR431A1, 60MM, HE  
 AR-M60, 60MM, HE, MORTAR  
 HE 80, 60-MM, HE  
 NR 431 A1, 60MM, CARTRIDGE, HE  
 UNKNOWN, 60MM, MORTAR, HE  
 UNKNOWN, 60MM, CARTRIDGE, MORTAR, HE  
 HE 83 LD

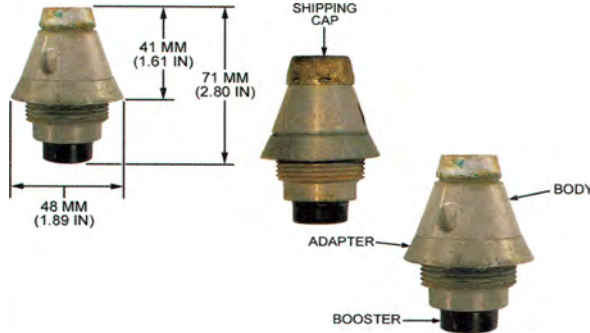

## CHINESE PROJECTILE FUZE, PD, PAI-1A

Ordnance used with:  
 TH521, 82-MM, HE  
 TYPE 53, 82-MM, HE  
 TYPE 53, 82 MM, SMOKE, WP  
 TYPE 53, 82MM, CARTRIDGE, HE, MORTAR  
 M43A1, CARTRIDGE, 81MM, HE  
 M43A1, 81MM, HE  
 M-57D MK 1, 82MM, MORTAR, HE  
 N.E.W. 6.80 G

## AUSTRIAN PROJECTILE FUZE, PD, T37A1B1

Ordnance used with:

HE 70, 81-MM, HE

HE 70LD, 81-MM, MORTAR, LONG DISTANCE, HE

AR-M60, 60MM, HE, MORTAR

HE 80, 60-MM, HE

HE 83 LD

HE 83, 82-MM, MORTAR, HE

HE83 LD, 82MM, HE

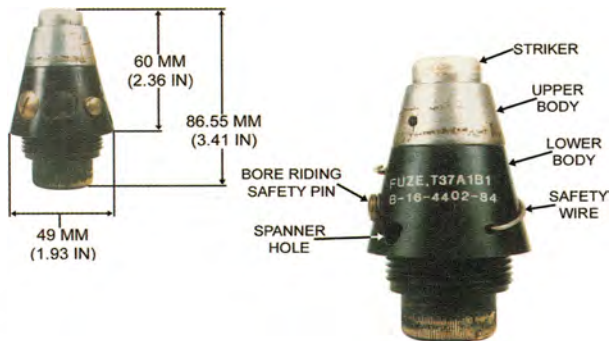

## GERMAN (FEDERAL REPUBLIC) PROJECTILE FUZE, PD, DM111A2, (AZ 111 A2), AZ DM 111A2

Ordnance used with:

NR431A1, 60MM, HE

BPD-IM1, 81-MM MORTAR, HE

NM123, 81-MM, HE

HE 70, 81-MM, HE

HE 70LD, 81-MM, MORTAR, LONG DISTANCE, HE

UNKNOWN, 60-MM, HE

64, 81-MM, HE

N.E.W. 15.00 G

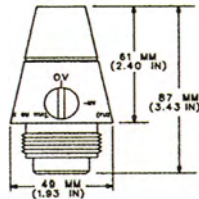



## IRANIAN PROJECTILE FUZE, PD, AZ111

Ordnance used with:  
 M73, 60-MM, HE, MORTAR  
 TRM73, 60-MM, HE, MORTAR  
 MDL. UNKNOWN, 60MM, MORTAR, HE  
 UNKNOWN, 120MM, MORTAR, HE  
 UNKNOWN, 60MM, MORTAR, HE  
 UNKNOWN, 60MM, CARTRIDGE, MORTAR, HE  
 M73, CARTRIDGE, 60-MM, MORTAR

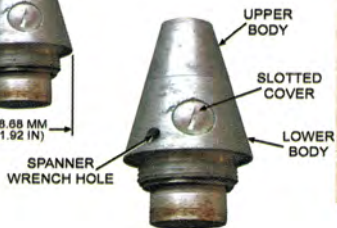
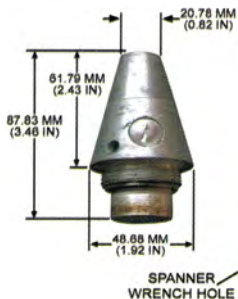

## IRANIAN PROJECTILE FUZE, PD, AZJV111A2

Ordnance used with:  
 NR431A1, 60MM, HE  
 NR 431 A1, 60MM, CARTRIDGE, HE

N.E.W. 18.00 G

## PAKISTANI PROJECTILE FUZE, PD, PAI-1A

Ordnance used with:

UNKNOWN, 60-MM, MORTAR, HE

UNKNOWN, 60-MM, SMOKE, WP, MORTAR

UNKNOWN, 60-MM, CARTRIDGE, MORTAR, HE

UNKNOWN, 60-MM, CARTRIDGE, MORTAR, SMOKE, WP

M57 DA-2, 81MM, MORTAR, HE

M-57D MK 1, 82MM, MORTAR, HE

M-57D MK 1, CARTRIDGE, 82MM, MORTAR, HE

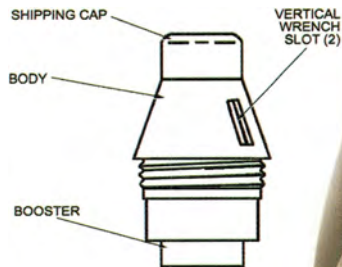

## SPANISH PROJECTILE FUZE, PD, PDB 332

Ordnance used with:

ER, 82MM, HE, MORTAR

M96, 82-MM, HE, MORTAR

ER, 82MM, CARTRIDGE, HE, MORTAR

M96, 82MM, CARTRIDGE, HE, MORTAR

ER, 82MM, SMOKE, WP, MORTAR (EXTENDED RANGE)

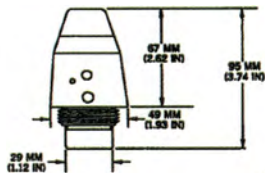

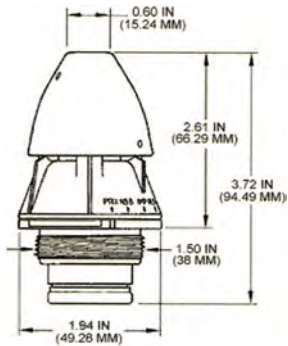

## U.S. PROJECTILE FUZE, MULTIOPTION, M734

Ordnance used with:

M821, 81-MM, HE

M821A1, 81MM, HE

M888, 60-MM, HE, MORTAR

M889, 81-MM, HE

M889A1, 81MM, HE

M933, PROJECTILE, 120-MM, HE, MORTAR

M934, CARTRIDGE, 120-MM, MORTAR, HE

N.E.W. 8.42 G

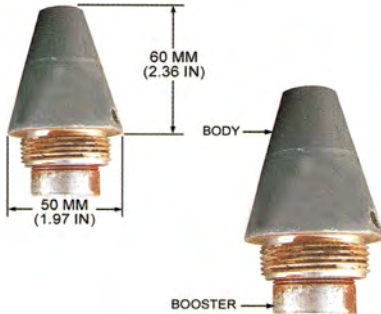

## IRANIAN PROJECTILE FUZE, PD, AZ111-A2

Ordnance used with:

M512, 60-MM, HE, MORTAR

UNKNOWN, 81MM, HE, MORTAR

UNKNOWN, 120MM, MORTAR, HE

M43A1, CARTRIDGE, 81MM, HE

M43A1, 81MM, HE

MDL. UNKNOWN, CARTRIDGE, 120MM, HE, MORTAR

## U.S. PROJECTILE FUZE, PD, M935

Ordnance used with:

M49A2E1, 60-MM, MORTAR, HE

M49A3, 60-MM, MORTAR, HE

M49A2E1, 60-MM, CARTRIDGE, MORTAR, HE

M49A3, 60-MM, CARTRIDGE, MORTAR, HE

M49A4, 60-MM, HE

M50A3, CARTRIDGE, 60-MM, TP

M722, CARTRIDGE, 60-MM, SMOKE, WP

N.E.W. 14.00 G

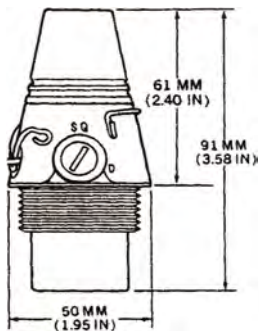

## U.S. BOMB FUZE, TAIL, IMPACT, SHORT DELAY, M905

Ordnance used with:

BLU-110A/B, BOMB, GPLD, 1,000 LB

BLU-111A/B, BOMB, GPLD, 500 LB

BLU-82/B, BOMB UNIT, BLAST, CRADLED

GBU-10/B, BOMB UNIT, GUIDED

GBU-10A/B, BOMB UNIT, GUIDED

GBU-10C/B, BOMB UNIT, GUIDED

GBU-10D/B, BOMB UNIT, GUIDED

N.E.W. 2.00 G

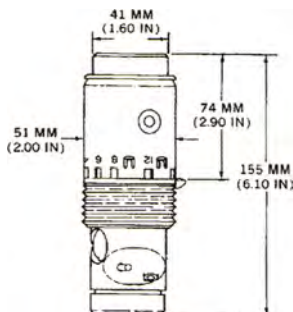

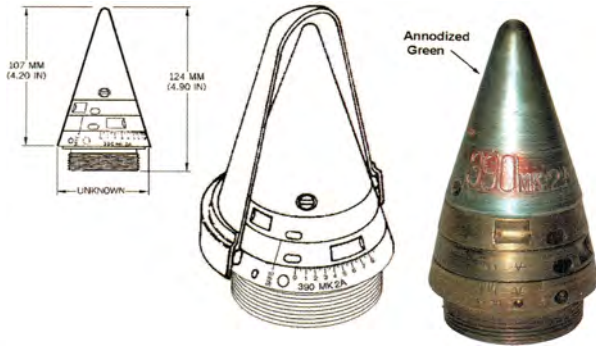

## U.K. PROJECTILE FUZE, PTT, NO. 390 MK 2A

Ordnance used with:  
 L32, CARTRIDGE, 76 MM, SMOKE  
 SX-1057  
 MK 4, 3-INCH, SMOKE, MORTAR

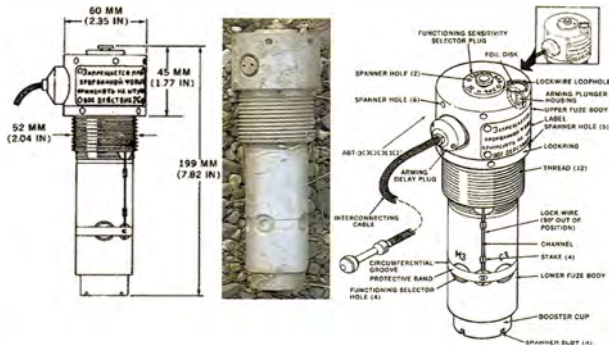

## U.S.S.R. BOMB FUZE, NOSE & TAIL, IMPACT, AVT-E

Ordnance used with:  
 FAB-1500 M54, BOMB, GENERAL PURPOSE  
 FAB-1500 M46, BOMB, GENERAL PURPOSE  
 FAB-250 M54, BOMB, GENERAL PURPOSE  
 FAB-250 SHN, BOMB, HE, RETARDED, 275 KG  
 FAB-500 M46, BOMB, GENERAL PURPOSE  
 FAB-500 M54, BOMB, GENERAL PURPOSE  
 FAB-500SH, GENERAL PURPOSE, 500 KG

## U.S.S.R. BOMB FUZE, NOSE AND TAIL, AVU

Ordnance used with:  
FAB 500, M62, BOMB, GP, 500 KG  
OFAB 100 120, BOMB, FRAG  
OFAB-250-270, BOMB, FRAGMENTATION

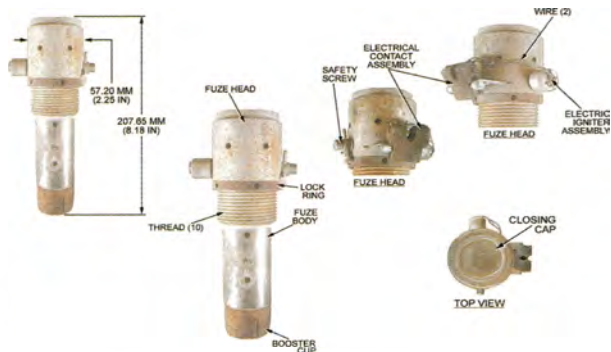

## U.S.S.R. BOMB FUZE, NOSE AND TAIL, AVU-ETM

Ordnance used with:  
OFAB 100 120, BOMB, FRAG  
PF.K ZB250SH, BOOSTER, FIRE BOMB  
PFK-ZB 250SH, IGNITER, FIRE BOMB  
PFKZB-250SH, IGNITER (INCENDIARY BOMB)  
PF.K ZB-500SH, BOOSTER, INCENDIARY

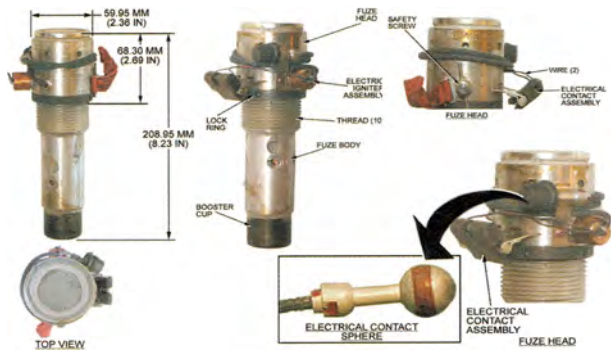

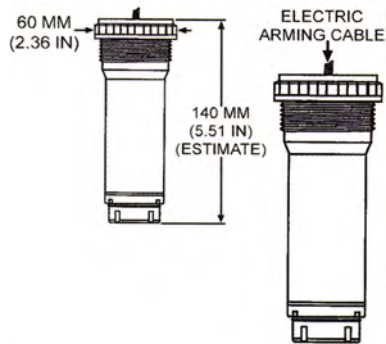

**U.S.S.R. BOMB FUZE, NOSE AND TAIL, IMPACT, AVB-E**

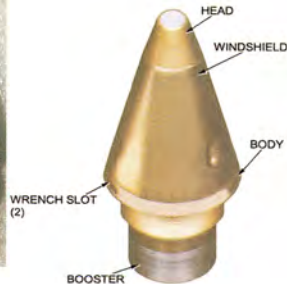
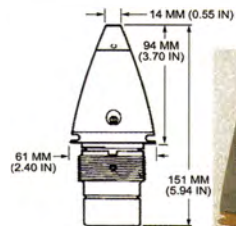

**PAKISTANI PROJECTILE FUZE, PD, PDM 557**

Ordnance used with:  
 M125A1, BOOSTER  
 M107, 155 MM, HE  
 M107, 155 MM, HE  
 M106, 203 MM, HE  
 UNKNOWN, 105-MM, HE  
 UNKNOWN, 105-MM, CARTRIDGE, HE  
 UNKNOWN, 105-MM, SMOKE, WP

## U.S. PROJECTILE FUZE, PD, M557

Ordnance used with:

M1, 105-MM, HE

M101, 155 MM, HE (GUN)

M104, 155 MM, SMOKE, WP OR FS

M106, 8-INCH, HE

M121, 155-MM, GAS, VX

M121A1, 155-MM, GAS, VX OR GB

M122, 155-MM, GAS, GB

N.E.W. 24.00 G

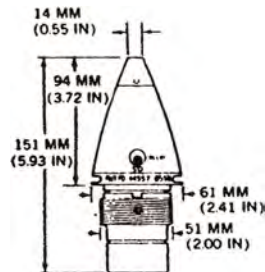

## U.S. PROJECTILE FUZE, PD, M557

Ordnance used with:

M1, 105-MM, HE

M101, 155 MM, HE (GUN)

M104, 155 MM, SMOKE, WP OR FS

M106, 8-INCH, HE

M121, 155-MM, GAS, VX

M121A1, 155-MM, GAS, VX OR GB

M122, 155-MM, GAS, GB

N.E.W. 24.00 G

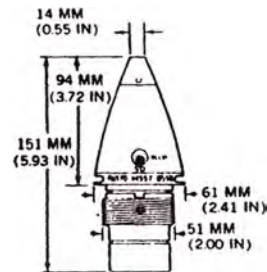

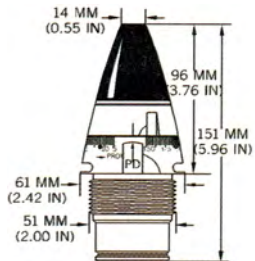

## U.S. PROJECTILE FUZE, PROXIMITY M732

Ordnance used with:  
 MK 81 MOD 0, 5-IN/54, HE-CVT, HI-FRAG  
 M1, 105-MM, HE  
 M106, 8-INCH, HE  
 M121A1, 155-MM, GAS, VX OR GB  
 M329, 4.2-IN (107-MM), HE  
 M329A1, 4.2-IN (107-MM), HE  
 M329A1E1, 4.2-IN (107-MM), HE

N.E.W. 5.96 G

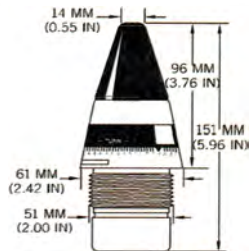

## U.S. PROJECTILE FUZE, PROXIMITY M732E2 (M732A2)

Ordnance used with:  
 M1, 105-MM, HE  
 M106, 8-INCH, HE  
 M121, 155-MM, GAS, VX  
 M329, 4.2-IN (107-MM), HE  
 M329A1, 4.2-IN (107-MM), HE  
 M329A1E1, 4.2-IN (107-MM), HE  
 M329A2, 4.2-IN (107-MM), HE

N.E.W. 28.00 G

## U.S. PROJECTILE FUZES, PD, MK 399 MODS 0 & 1, AND MK 407 MODS 0 & 1

Ordnance used with:

M60, 105-MM, CARTRIDGE, SMOKE, WP  
MK 166 MOD 0, 76-MM/62 CALIBER, HE-PD  
MK 58 MOD 0, PROJECTILE, 5-INCH/54, RAP  
MK 58 MOD 1, PROJECTILE, 5-INCH/54, RAP  
MK 283 MOD 0, 76MM, CARTRIDGE, HE-PD  
MK 55, PROJECTILE, 5 INCH/54, HE-CVT  
MK 64, PROJECTILE, 5 INCH/54, HE-CVT

N.E.W. 12.27 G

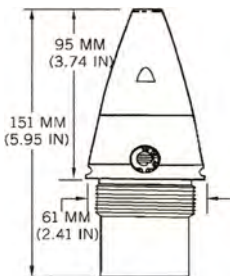

## U.S.S.R. BOMB FUZE, NOSE AND TAIL, AVU-E

Ordnance used with:

OFAB 100 120, BOMB, FRAG  
FAB-1500 M54, BOMB, GENERAL PURPOSE  
FAB-1500 M46, BOMB, GENERAL PURPOSE  
FAB-250 M-62, BOMB, GENERAL PURPOSE  
FAB-250 M54, BOMB, GENERAL PURPOSE  
FAB-250 SHN, BOMB, HE, RETARDED, 275 KG  
FAB-3000 M46, BOMB, GENERAL PURPOSE

N.E.W. 63.00 G

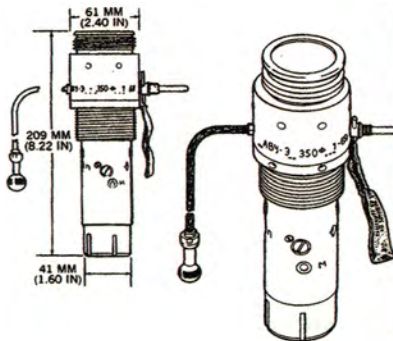

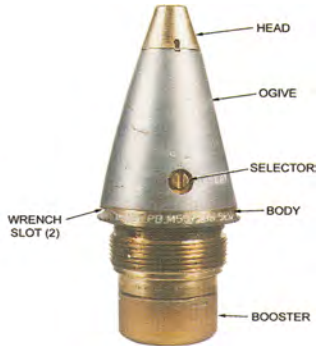

### YUGOSLAV PROJECTILE FUZE, PD, UTU M557

Ordnance used with:

- M1, 105-MM, HE
- M1, 105-MM, HE
- M84, 152-MM, HE
- M95, 122-MM, HE
- M60, 105-MM, CARTRIDGE, SMOKE WP
- 462, 122-MM, HE
- M1, CARTRIDGE, 105 MM, HE

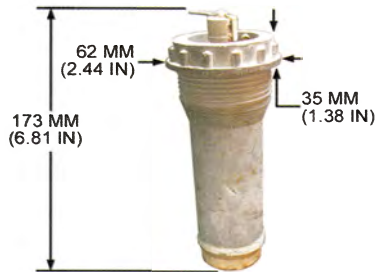

### U.S.S.R. BOMB FUZE, AVB-M

## U.S.S.R. BOMB FUZE, NOSE AND TAIL, AV-2 D/U

Ordnance used with:

FAB-1500 M54, BOMB, GENERAL PURPOSE  
FAB-1500 M46, BOMB, GENERAL PURPOSE  
FAB-250 M46, BOMB, GENERAL PURPOSE  
FAB-250 M54, BOMB, GENERAL PURPOSE  
FAB-250 SHN, BOMB, HE, RETARDED, 275 KG  
FAB-3000 M46, BOMB, GENERAL PURPOSE  
FAB-500T, BOMB, GENERAL PURPOSE

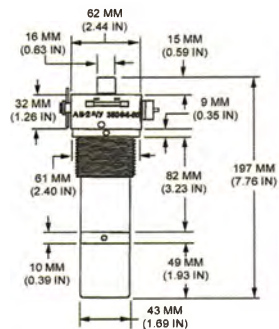

## CHINESE PROJECTILE FUZE, PROXIMITY (VT), MD-12A1

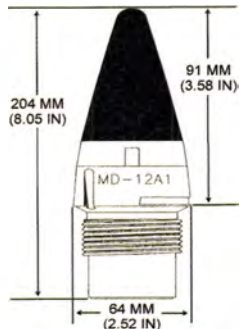

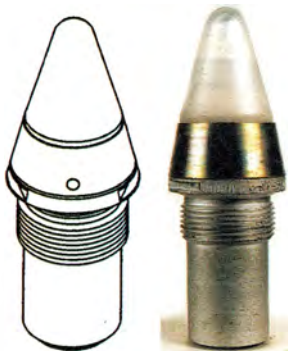
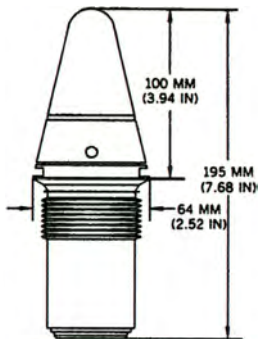

### CHINESE PROJECTILE FUZE, PROXIMITY/PD, MD-11

Ordnance used with:  
 TYPE 59, 130MM, HE  
 TYPE 66 MODIFIED, 152 MM, HE  
 TYPE 59 MODIFIED, PROJECTILE, 130-MM, HE

N.E.W. 13.82 G

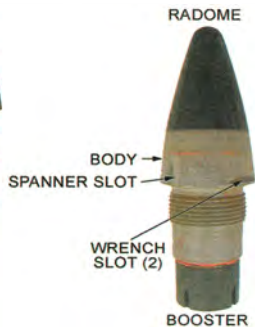

### CHINESE PROJECTILE FUZE, PROXIMITY/PD, MD-12A

N.E.W. 80.02 G

## FRENCH ROCKET FUZE, PD, ALL-WAY ACTING, 156

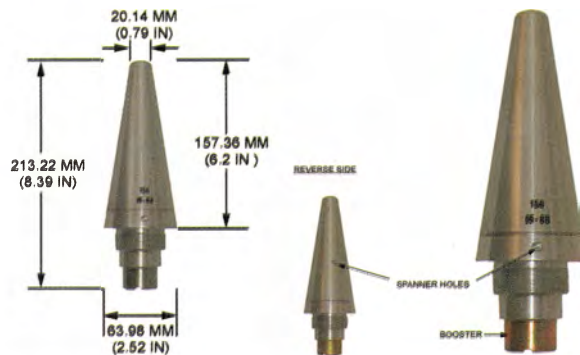

N.E.W. 28.00 G

## FRENCH ROCKET FUZE, PD, S21



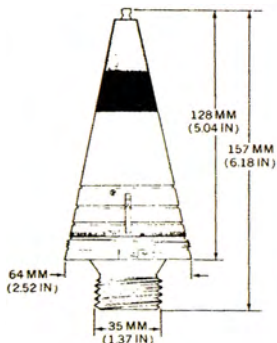

## GERMAN (PEOPLE'S REPUBLIC) ROCKET FUZE, PTT, MODEL T-7

Ordnance used with:  
 FLG-5000/M68, 116MM, ILLUMINATION  
 MDL. UNKNOWN, 116 MM, ILLUMINATION  
 ATI 5000, 116MM, DECOY, (AIR TARGET IMITATOR)  
 ATI 5000 (S), 116MM, DECOY (AIR TARGET IMITATOR)

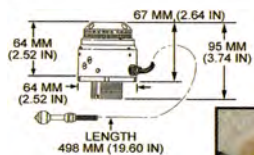

## U.S.S.R. BOMB FUZE, ATK-2A



## U.S.S.R. BOMB FUZE, ATK-EA

Ordnance used with:  
RBK-250-275, DISP.  
RBK-500 AO-2.5 RTM, CLUSTER BOMB

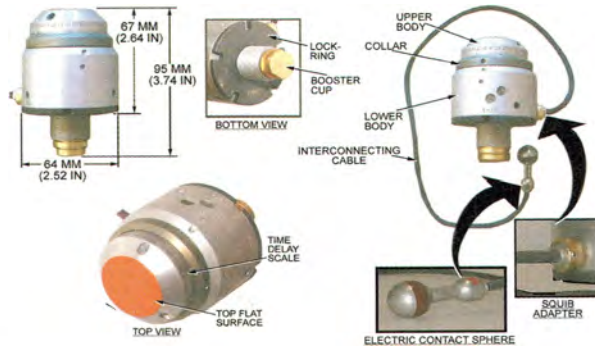

## U.S.S.R. BOMB FUZE, MT, ATK-2B

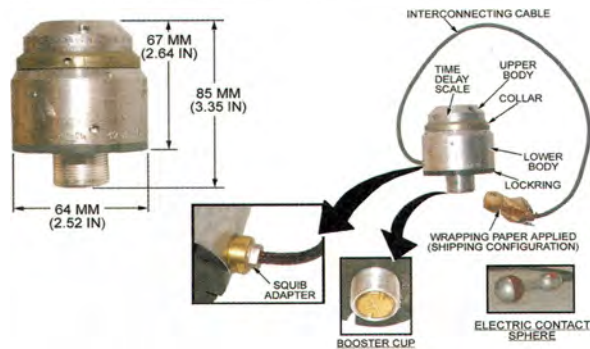

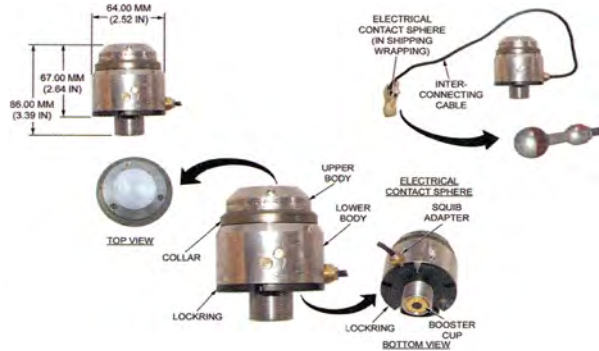

## U.S.S.R. BOMB FUZE, MT, ATK-EB

Ordnance used with:  
 RBK-250-275, DISP.  
 ZAB-50TG TYPE C, BOMB, INCENDIARY  
 PTAB-500-225, CLUSTER/DISPENSER  
 RBK-500-225, CLUSTER/DISPENSER  
 RBK-250, DISP.

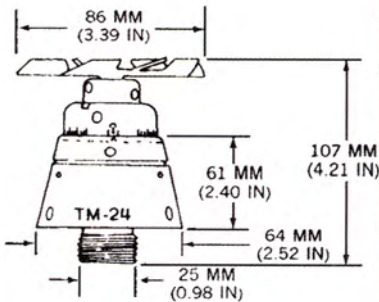

## U.S.S.R. BOMB FUZE, NOSE & TAIL, MT, TM-24A

Ordnance used with:  
 FAB 100 ZE, BOMB, HE, INCENDIARY  
 ZAB 100 TSHCH, CBU, INCENDIARY  
 ZAB 50T SHCH, CBU, INCENDIARY  
 PROSAB-250, CBU  
 BRAB-1000, BOMB, ARMOR PIERCING  
 FOTAB-100-80, BOMB, PHOTOFLASH  
 KHAB-25, BOMB, CHEMICAL

## U.S.S.R. BOMB FUZE, NOSE & TAIL, MT, TM-24B

Ordnance used with:

FAB 100 ZE, BOMB, HE, INCENDIARY

P 50 75, BOMB, PRACTICE

ZAB 100 TSHCH, CBU, INCENDIARY

ZAB 50T SHCH, CBU, INCENDIARY

RBK-250, CLUSTER, ADAPTER

RBK-250-275, DISP.

RBK-500, DISP. (OLD STYLE)

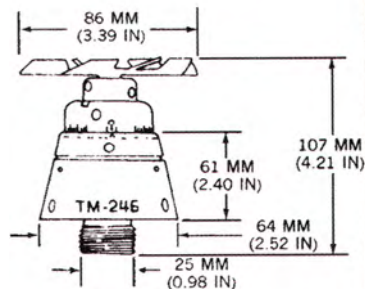

## U.S.S.R. BOMB FUZE, NOSE, AVR-5

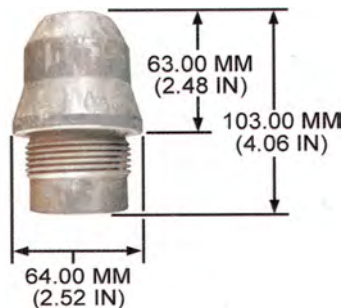

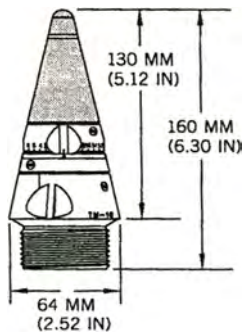

**U.S.S.R. PROJECTILE FUZE, MT, TM-16L**

Ordnance used with:  
SP-46, 130-MM, ILLUMINATION

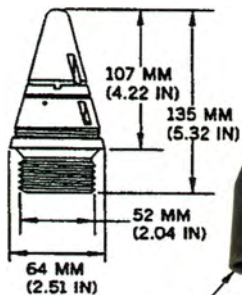

SHIPPING CAP

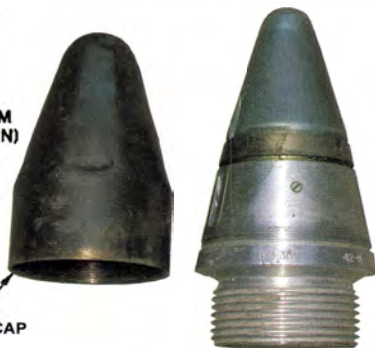

**U.S.S.R. PROJECTILE FUZE, MT, VM-30**

Ordnance used with:  
O-415, 100-MM, FRAG  
O-415, 100-MM, HE-FRAG

N.E.W. 6.00 G

## U.S.S.R. PROJECTILE FUZE, MT, VM-30-L1

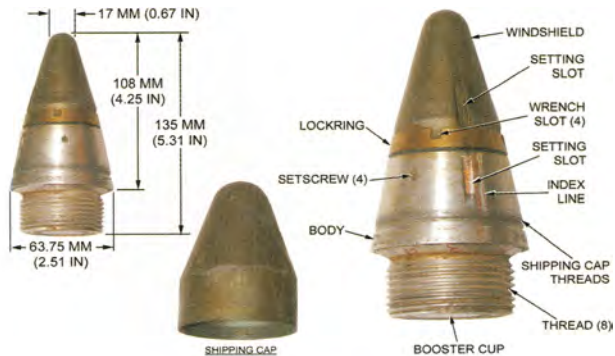

N.E.W. 58.68 G

## U.S.S.R. PROJECTILE FUZE, MT, VM-30L

Ordnance used with:  
O-415, 100-MM, FRAG  
O-415, 100-MM, HE-FRAG

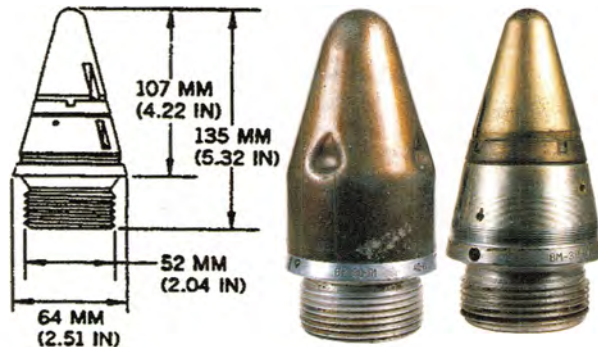

N.E.W. 6.00 G

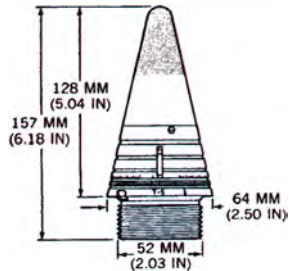

FUZE WITH SHIPPING CAP

## U.S.S.R. PROJECTILE FUZES, TIME, T-5 & T-11

Ordnance used with:  
 O-365, 85-MM, PROJECTILE, HE, (2 PIECE)  
 UO-365, 85-MM, CARTRIDGE, HE  
 UO-365K, 85-MM, CARTRIDGE, FRAG  
 M69, 85-MM, HE  
 O-365 (ONE-PIECE), 85-MM, HE-FRAG

N.E.W. 0.16 LB

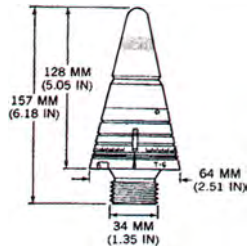

## U.S.S.R. PROJECTILE FUZES, TSQ, T-6; & TIME OR TSQ, T-7

Ordnance used with:  
 OS-464, 122-MM, ILLUM  
 A-462, 122-MM, PROPAGANDA  
 S-463, 122-MM, ILLUM  
 S-463ZH, 122-MM, ILLUM  
 SH-354G, 76-MM, SHRAPNEL

N.E.W. 10.00 G

## U.S.S.R. ROCKET FUZE, PD, DKZ-B

Ordnance used with:  
9M22M, 122 MM, HE-FRAG, 6 FOOT  
SAKR-10  
UNKNOWN, 122MM, HE, TWO-STAGE, S-TO-S

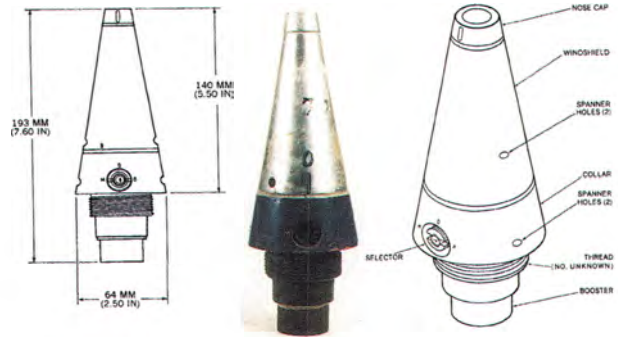

## U.S.S.R. ROCKET FUZE, PD, MRV

Ordnance used with:  
9M22M, 122 MM, HE-FRAG, 6 FOOT  
SAKR-10  
UNKNOWN, 122MM, HE, TWO-STAGE, S-TO-S

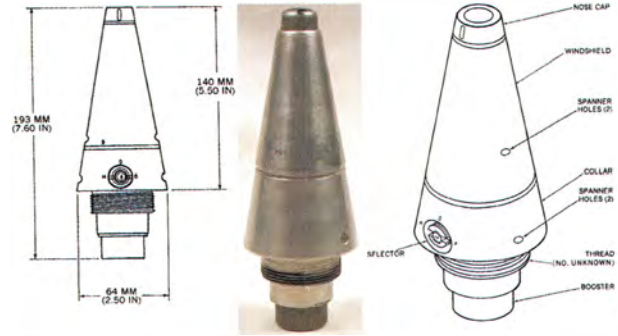

N.E.W. 88.00 G

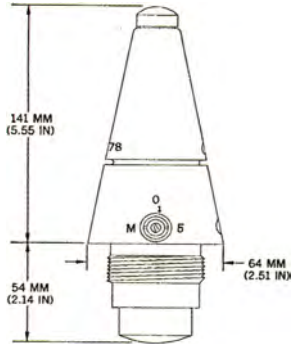

## U.S.S.R. ROCKET FUZE, PD, MRV-U

Ordnance used with:

9M22M, 122 MM, HE-FRAG, 6 FOOT

SAKR-10

9M22U, 122 MM, HE-FRAG, 9 FOOT

UNKNOWN, 122MM, HE, TWO-STAGE, S-TO-S

MDL UNK, WHD, 122 MM, CHEMICAL, NON-PERSISTANT

9M27F, 220MM, HE

9N128F, WARHEAD, 220MM, HE

N.E.W. 29.00 G

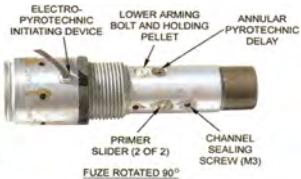
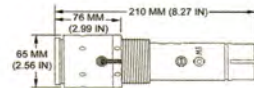

## U.S.S.R. BOMB FUZE, NOSE AND TAIL, IMPACT INERTIA, AVU-ET

Ordnance used with:

FAB 500, M62, BOMB, GP, 500 KG

OFAB 100 120, BOMB, FRAG

KAB-500KR, TV GUIDED

OFAB-250-270, BOMB, FRAGMENTATION

FAB-100 M80, BOMB, GP, 100 KG

UNKNOWN, GUIDANCE KIT

PF.K ZB-500SH, BOOSTER, INCENDIARY

N.E.W. 59.44 G

**AFGHAN FIRING DEVICE, ELECTRONIC DELAY,  
3/6/12 MINUTE, MODEL UNKNOWN**

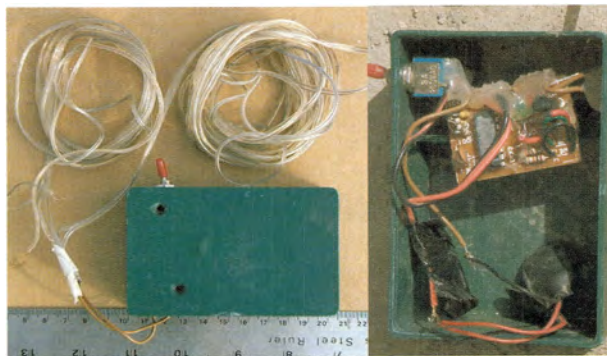

**U.S.S.R. BOMB FUZE, NOSE AND TAIL, IMPACT,  
AV 527**

Ordnance used with:  
ZAB 500 SH, BOMB, INCENDIARY, 500 KG  
RBK-500 BETAB, DISPENSER, BETAB, 500 KG  
RBK-500 PTAB-1M, CBU  
KP-527, EXPLOSIVE DISCONNECT/DEPLOYMENT MECHANISM  
RBK-500 AO-2.5 RTM, CLUSTER BOMB  
RBK-500 AO-2.5 RT, CBU  
RBK-500 ZAB 2.50SM, CBU

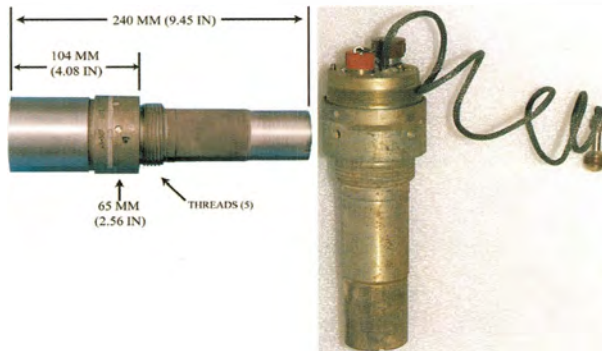

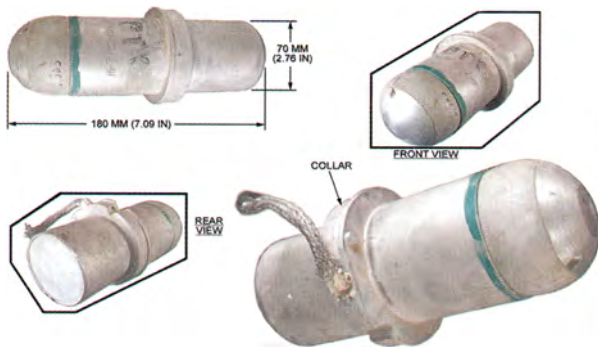

### U.S.S.R. BOMB FUZE, UP-581

Ordnance used with:  
FAB-500 SHN, GENERAL PURPOSE, 500 KG

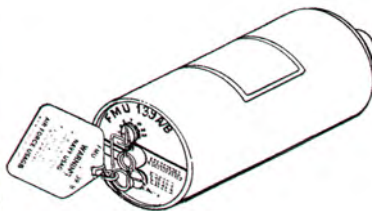
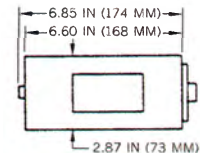

### U.S. BOMB FUZES, ELECTRONIC, NOSE AND/OR TAIL, IMPACT, FMU-139A/B AND FMU-139B/B

Ordnance used with:  
BLU-110A/B, BOMB, GPLD, 1,000 LB  
BLU-111A/B, BOMB, GPLD, 500 LB  
DSU-30/B, BOMB TARGET DETECTING DEVICE  
DSU-33A(D-2)/B, SENSING ELEMENT, DUMMY  
DSU-33A/B, SENSING ELEMENT, PROX.  
GBU-10/B, BOMB UNIT, GUIDED  
GBU-10A/B, BOMB UNIT, GUIDED

N.E.W. 129.00 G

## U.S.S.R. ROCKET FUZE, PROXIMITY, RV-24

Ordnance used with:  
S-24, 240-MM, FIXED FIN, HE, A-TO-S

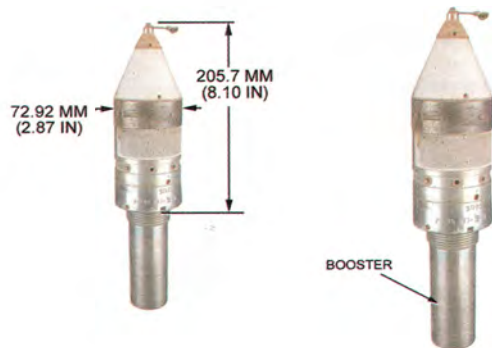

## U.S. PROJECTILE FUZE, PD, FMU-153/B

Ordnance used with:  
M1 (MOD), CARTRIDGE, 105MM, HE  
M1 (MOD), PROJECTILE, 105MM, HE  
HF M1 (MOD), CARTRIDGE, 105MM, HE  
HF M1 (MOD), 105MM, HE



N.E.W. 12.27 G

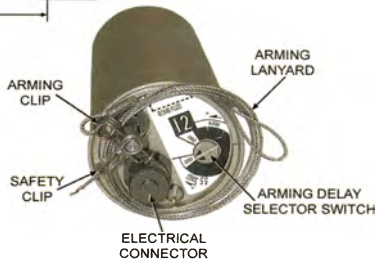
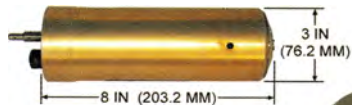

## U.S. BOMB FUZE, NOSE AND TAIL, IMPACT, FMU-143J/B

Ordnance used with:  
 GBU-24/B, BOMB UNIT, GUIDED  
 GBU-24A/B, BOMB UNIT, GUIDED  
 BLU-118/B, PENETRATOR, 2000 LB, THERMOBARIC

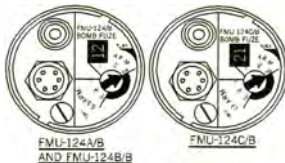
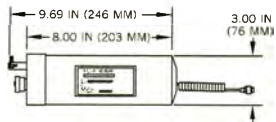

## U.S. BOMB FUZES, NOSE & TAIL, IMPACT, FMU-124A/B, FMU-124B/B, AND FMU-124C/B

Ordnance used with:  
 GBU-15(V)1/B  
 AGM-142A, AIR-TO-GROUND  
 HAVE NAP  
 AGM-142B, AIR-TO-GROUND  
 HAVE NAP  
 AGM-142C, AIR-TO-GROUND  
 HAVE NAP

N.E.W. 133.00 G



**U.S. BOMB FUZES, NOSE & TAIL, IMPACT, FMU-143/B,  
FMU-143A/B, FMU-143B/B, FMU-143D/B, FMU-143E/B,  
FMU-143F/B, FMU-143G/B & FMU-143H/B**

Ordnance used with:

- BLU-113/B, PENETRATOR
- BLU-113A/B, PENETRATOR
- GBU-10C/B, BOMB UNIT, GUIDED
- GBU-10G/B, BOMB UNIT, GUIDED
- GBU-15(V)2/B
- GBU-15(V)31/B, BOMB UNIT, GUIDED
- GBU-15(V)32/B, BOMB UNIT, GUIDED

N.E.W. 133.00 G

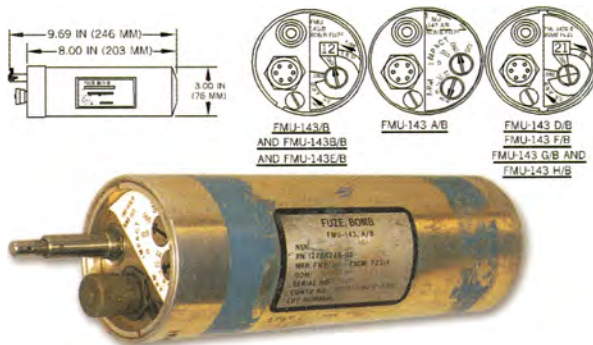

**U.S. PROJECTILE FUZE, PD, MK407 MOD 1 (HIP)**

Ordnance used with:

- M1, 105-MM, HE
- M1 (MOD), CARTRIDGE, 105MM, HE
- M1 (MOD), PROJECTILE, 105MM, HE

N.E.W. 12.27 G

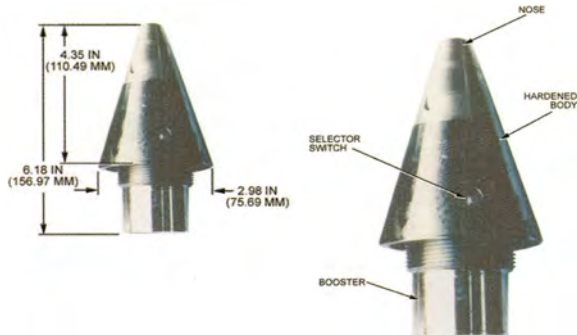

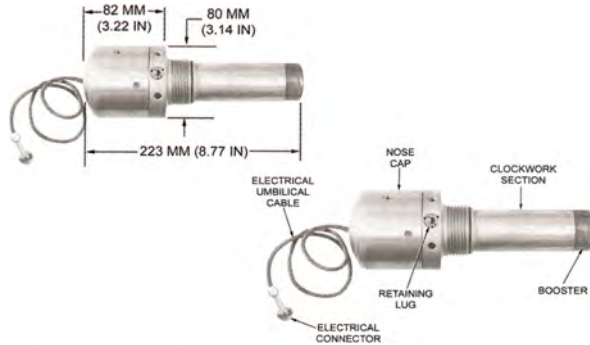

## U.S.S.R. BOMB FUZE, NOSE AND TAIL, LONG DELAY, ANTIDISTURBANCE, AVPZ

Ordnance used with:  
 FAB-1500 M54, BOMB, GENERAL PURPOSE  
 FAB-3000 M54, GENERAL PURPOSE  
 MDL. UNKNOWN, BATTERY, 47 VOLTS, FOR AVPZ BOM...

N.E.W. 50.00 G

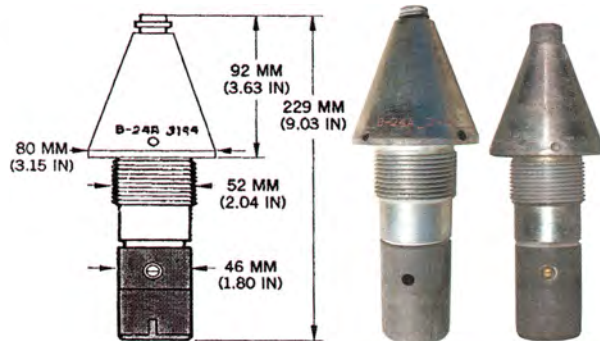

## U.S.S.R. ROCKET FUZE, NOSE, PD, V-24A

Ordnance used with:  
 F-961, 240 MM, SPIN STABILIZED, HE, S-TO-S  
 F-961U, 240 MM, SPIN STABILIZED, HE, S-TO-S  
 S-24, 240-MM, FIXED FIN, HE, A-TO-S

## U.S. PROJECTILE FUZE, MTSQ, M772

Ordnance used with:

M721, CARTRIDGE, 60-MM, ILLUMINATING

M-819, 81-MM, CARTRIDGE, SMOKE, RP, MORTAR

M819, 81-MM, CARTRIDGE, SMOKE, RP, MORTAR

M853A1 CARTRIDGE, 81-MM, ILLUM

M853A1, 81MM, ILLUM

M721, PROJECTILE, 60-MM, MORTAR, ILLUMINATING

M-819, 81-MM, SMOKE, RP, MORTAR

N.E.W. 6.00 G

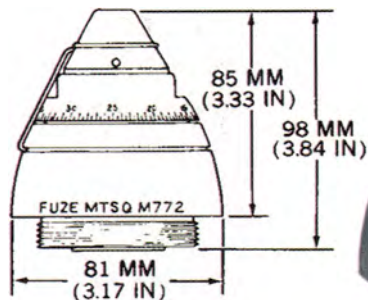

## SWEDISH PROJECTILE FUZE, MT, FFV 447

Ordnance used with:

FFV 441B, 84-MM, CARTRIDGE, HE-FRAG

FFV 441B, 84-MM, HE-FRAG

N.E.W. 5.05 G

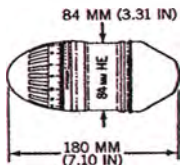



## U.S. BOMB FUZE, NOSE, M904E4

Ordnance used with:

M117A3

BLU-110A/B, BOMB, GPLD, 1,000 LB

BLU-111A/B, BOMB, GPLD, 500 LB

BLU-82/B, BOMB UNIT, BLAST, CRADLED

M117, 750 LB, GP

M117A1, 750 LB, GP

M117A1E1, 750 LB, GP

N.E.W. 75.00 G

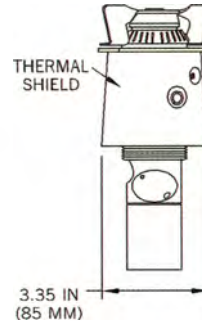

## U.S. BOMB FUZES, NOSE, M904E1, M904E2, AND M904E3

Ordnance used with:

M117A3

BLU-110A/B, BOMB, GPLD, 1,000 LB

BLU-111A/B, BOMB, GPLD, 500 LB

BLU-82/B, BOMB UNIT, BLAST, CRADLED

M117, 750 LB, GP

M117A1, 750 LB, GP

M117A1E1, 750 LB, GP

N.E.W. 75.00 G

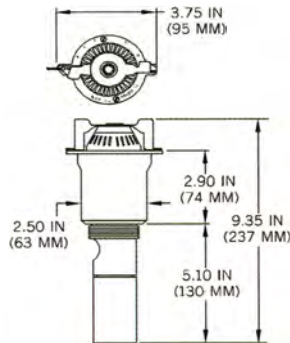

M904E1 (SHOWN)

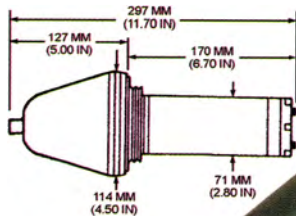

## U.S. BOMB TARGET DETECTING DEVICE, MK 43 MOD 0

Ordnance used with:  
 FMU-54A/B, BOMB FUZE, TAIL  
 M117, 750 LB, GP  
 M117A1, 750 LB, GP  
 M117A1E2, 750 LB, GP  
 M117A1E3, 750 LB, GP  
 M117A2, 750 LB, GP  
 M990, BOMB FUZE, TAIL, ELEC.

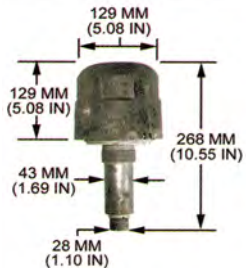

TOP VIEW  
 WITH NOSE CAP  
 REMOVED

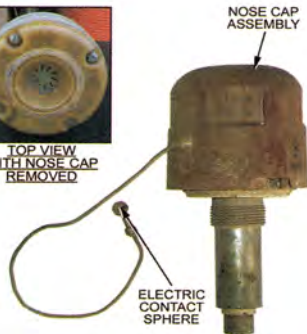

## U.S.S.R. BOMB FUZE, NOSE, PROXIMITY, 9-A-798

## U.S. BOMB SENSING ELEMENT, PROXIMITY, DSU-33A/B

Ordnance used with:

BLU-110A/B, BOMB, GPLD, 1,000 LB

BLU-111A/B, BOMB, GPLD, 500 LB

FMU-139/B, NOSE & TAIL, IMPACT

FMU-139A/B, NOSE & TAIL, IMPACT

M117, 750 LB, GP

M117A1, 750 LB, GP

M117A1E1, 750 LB, GP

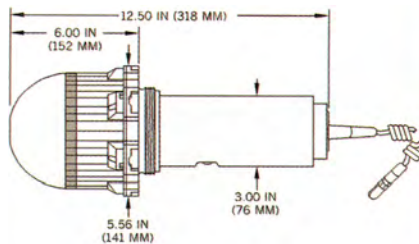

## AFGHAN KIT, FIRING DEVICE, RADIO CONTROLLED, MODEL UNKNOWN

Ordnance used with:

MDL. UNKNOWN, TRANSMITTER, RADIO CONTROLLED (RC)

MDL. UNKNOWN, RECEIVER, RADIO CONTROLLED (RC)

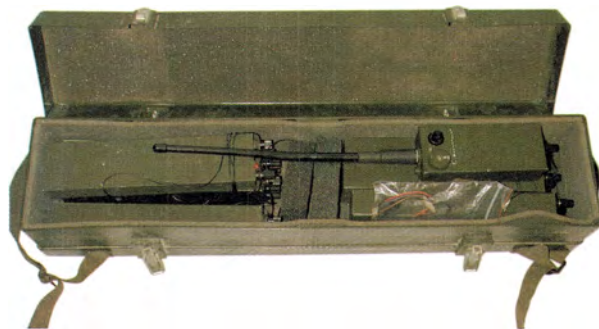



**U.S.S.R. ANTILIFT DEVICE, MS-3**

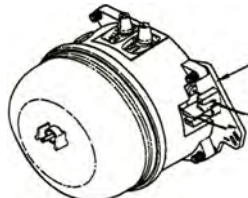
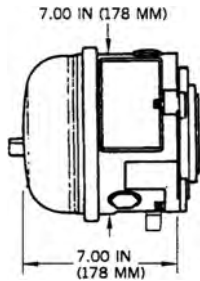

**FUZE ADAPTER  
(USED WITH  
MK 7 DISPENSER)**

**FMU-140/B**

**U.S. BOMB FUZE, NOSE, PROXIMITY, FMU-140/B**

Ordnance used with:  
MK 7 MOD 2, DISP.  
MK 7 MOD 3, DISP.  
MK 7 MOD 4, DISP.  
MK 7 MOD 6, DISP.  
SUU-58/B, DISP.  
APAM CLUSTER WEAPON  
CBU-59/B

N.E.W. 608.33 MG

## U.S. BOMB FUZE, NOSE, PROXIMITY, FMU-140A/B

Ordnance used with:

MK 7 MOD 2, DISP.

MK 7 MOD 3, DISP.

MK 7 MOD 4, DISP.

MK 7 MOD 6, DISP.

SUU-58/B, DISP.

APAM CLUSTER WEAPON

CBU-59/B

N.E.W. 608.33 MG

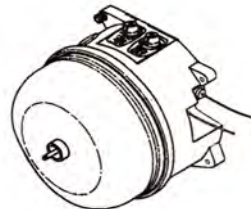
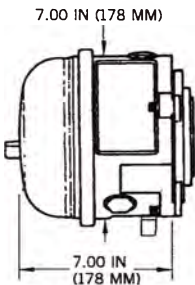

FMU-140A/B

***THIS PAGE INTENTIONALLY LEFT BLANK***

## FRENCH GRENADE, RIFLE, 40-MM, APERS/ ANTIVEHICLE, BTRG AP/AV (AP-AV-F2)

Ordnance used with:  
UNKNOWN, GRENADE, BD

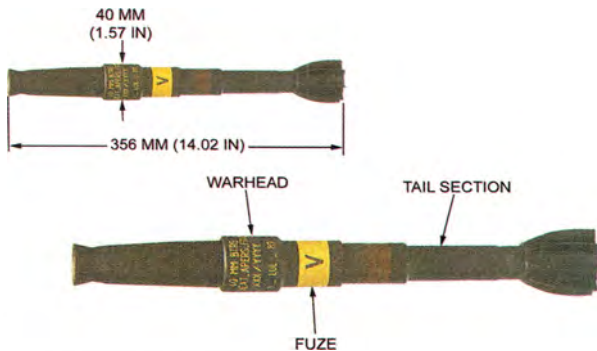

N.E.W. 63.00 G

## CHINESE GRENADE, HAND, FRAG, TYPE 73

Ordnance used with:  
UNKNOWN, GRENADE, ALL-WAY ACTING

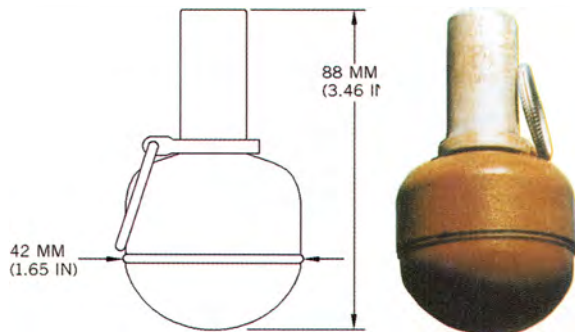

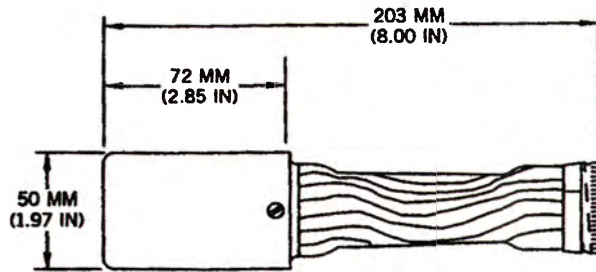

NONSERRATED SHORT  
CYLINDRICAL HEAD (A)

**CHINESE GRENADE, HAND, STICK, FRAG,  
NONSERRATED SHORT CYLINDRICAL BODY A**

N.E.W. 26.00 G



**CHINESE GRENADE, HAND, STICK, FRAG, M46**

N.E.W. 49.00 G

## EGYPTIAN GRENADE, HAND, FRAG, NO. 2

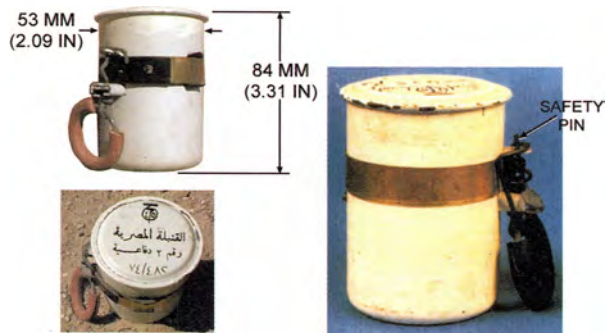

N.E.W. 42.00 G

## BULGARIAN GRENADE, HAND, FRAG, RGO-78

Ordnance used with:

DVM, GRENADE, STRIKER-RELEASE  
DVM-78, GRENADE, STRIKER-RELEASE  
UZRGM, GRENADE, STRIKER-RELEASE

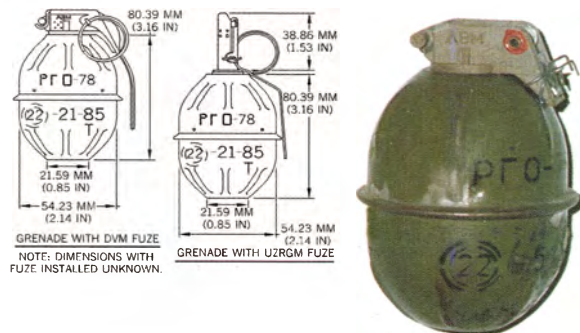

N.E.W. 82.00 G

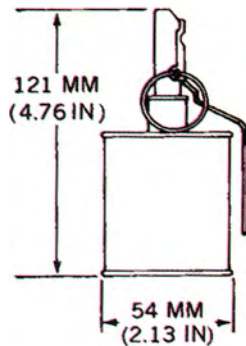

### U.S.S.R. GRENADE, HAND, DEFENSIVE, RG-42

Ordnance used with:  
 UZRG, GRENADE, STRIKER-RELEASE  
 UZRGM, GRENADE, STRIKER-RELEASE  
 FGM-1, GRENADE, STRIKER-RELEASE

N.E.W. 120.00 G

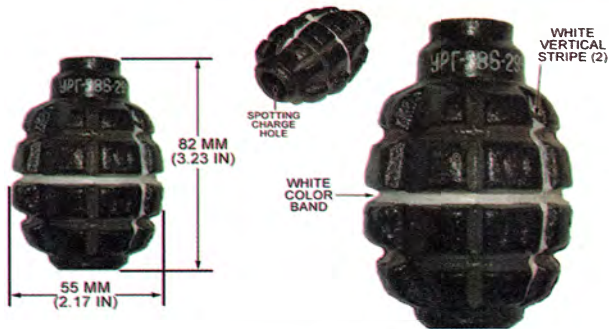

### RUSSIAN GRENADE, HAND, PRACTICE, URG

Ordnance used with:  
 UNKNOWN, GRENADE, STRIKER-RELEASE, PRACTICE

## U.S.S.R. GRENADE, HAND, DEFENSIVE, F-1; ROMANIAN GRENADE, TIP F-1

Ordnance used with:

F-IN-60, 55MM, RIFLE, FRAG

UZRG, GRENADE, STRIKER-RELEASE

UZRGM, GRENADE, STRIKER-RELEASE

UZRGM-2, GRENADE, HAND, STRIKER-RELEASE

(UZRGM COPY)

UNKNOWN, GRENADE, STRIKER-RELEASE

(UZRGM COPY)

N.E.W. 54.00 G

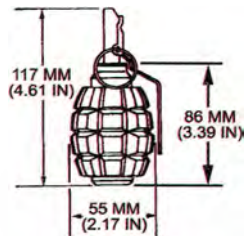

## U.K. GRENADE, HAND/RIFLE, APERS, HE-FRAG, L2A1

Ordnance used with:

L25A2, GRENADE, STRIKER-RELEASE

L25A1, GRENADE, STRIKER-RELEASE

L25A3, GRENADE, STRIKER-RELEASE

L25A4, GRENADE, STRIKER-RELEASE

L25A5, GRENADE, STRIKER-RELEASE

L25A6, GRENADE, STRIKER-RELEASE

L1A1, 56MM, ADAPTER, PROJECTION, GRENADE, RIFLE

N.E.W. 170.00 G

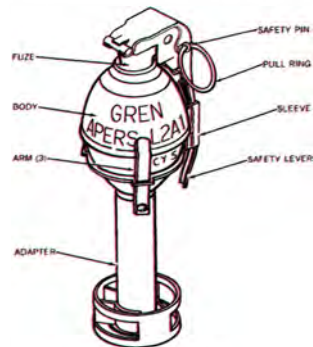
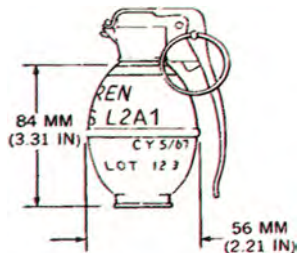

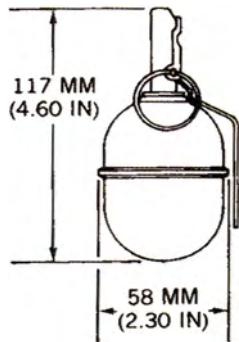

### U.S.S.R. GRENADE, HAND, DEFENSIVE, RGD-5

Ordnance used with:

DVM, GRENADE, STRIKER-RELEASE

DVM-78, GRENADE, STRIKER-RELEASE

UZRG, GRENADE, STRIKER-RELEASE

UZRGM, GRENADE, STRIKER-RELEASE

UZRGM-2, GRENADE, HAND, STRIKER-RELEASE

N.E.W. 111.00 G

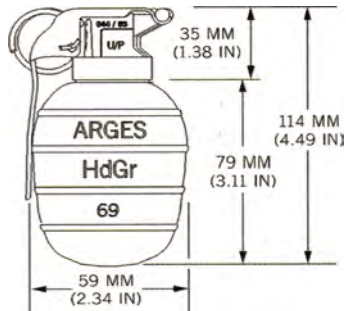

### AUSTRIAN GRENADE, HAND, FRAGMENTATION, HG 69; PAKISTANI P-1 MK 1

Ordnance used with:

P7 MK 1, LANDMINE, APERS, JUMPING

N.E.W. 62.00 G

## U.S.S.R. GRENADE, HAND, FRAG, RGN

Ordnance used with:

UDZ, GRENADE, STRKR-RELEASE, ALL-WAY ACTING, ...  
UDZ-S, GRENADE, STRKR-RELEASE, ALL-WAY ACTING...

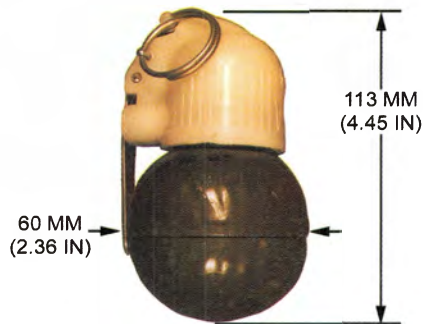

N.E.W. 114.00 G

## U.S.S.R. GRENADE, HAND, FRAG, RGO

Ordnance used with:

UDZ, GRENADE, STRKR-RELEASE, ALL-WAY ACTING, ...  
UDZ-S, GRENADE, STRKR-RELEASE, ALL-WAY ACTING...

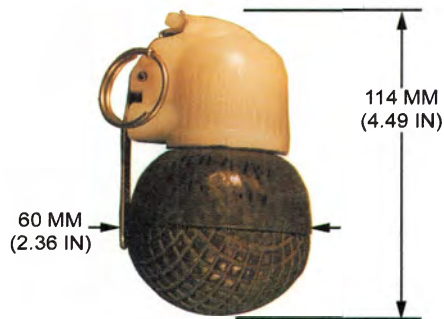

N.E.W. 92.00 G

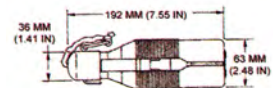

UNARMED

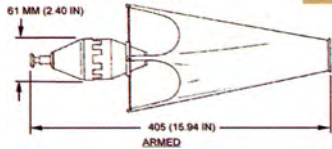

ARMED



**EGYPTIAN GRENADE, HAND, HEAT, TYPE 2 (HOSAM)**

N.E.W. 143.00 G

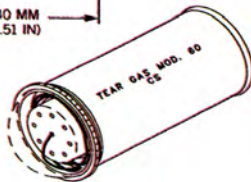
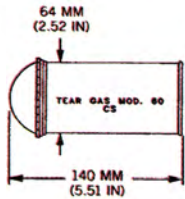

**ITALIAN GRENADES, HAND, SMOKE, M60F; AND CN-CS, M60L**

## U.S. GRENADE, HAND, FRAG, M67

Ordnance used with:  
M213, GRENADE, STRIKER-RELEASE

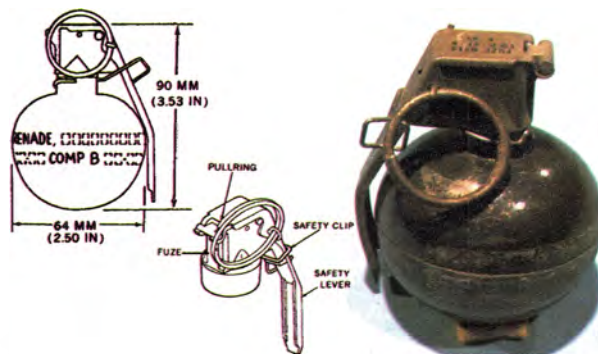

N.E.W. 184.00 G

## U.S. GRENADE, HAND, INCENDIARY, AN-M14

Ordnance used with:  
M201A1E2, GRENADE, STRIKER-RELEASE  
M201A1, GRENADE, STRIKER-RELEASE  
AN-M14, HAND, BODY, INCENDIARY

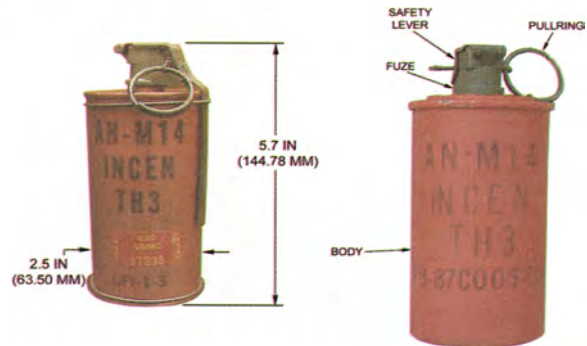

N.E.W. 0.48 G

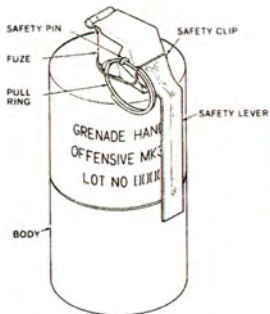
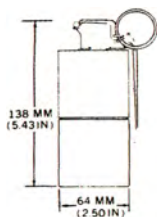

## U.S. GRENADE, HAND, OFFENSIVE, MK 3A2

Ordnance used with:  
M206A2, GRENADE, STRIKER-RELEASE  
M206A1, GRENADE, STRIKER-RELEASE

N.E.W. 226.00 G

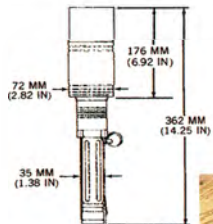

## U.S.S.R. GRENADES, HAND, HEAT, RKG-3, RKG-3T & RKG-3M

N.E.W. 604.00 G

**GREEK GRENADE, 76-MM, SMOKE,  
MULTISPECTRAL, NM186**



**SWEDISH GRENADE, 76-MM, PROJECTED, SMOKE  
(HC), DM45F1**



# U.S.S.R. GRENADE, HAND, HEAT, RKG-3EM

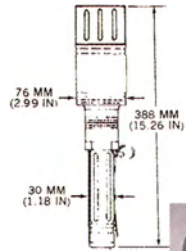

N.E.W. 434.00 G

**BULGARIAN CARTRIDGE, 73-MM, ROCKET, HEAT,  
PG-15V**

Ordnance used with:

PG-9, 73MM, HEAT

VP-9 G CH, ROCKET, PI ELEMENT

MDL. UNKNOWN, PG-9, 73MM, RKT MOTOR

PG-15P, 73MM, PROPELLING CHARGE

UNDESIGNATED, WARHEAD, 73MM, HEAT, FOR PG-9

VP-9 D CH, ROCKET, BD ELEMENT



**BULGARIAN CARTRIDGE, 73-MM, ROCKET, HEAT,  
PG-15VN**

Ordnance used with:

PG-9N, 73MM, HEAT

VP-9 G CH, ROCKET, PI ELEMENT

MDL. UNKNOWN, PG-9, 73MM, RKT MOTOR

PG-15P, 73MM, PROPELLING CHARGE

PG-9N, WARHEAD, 73-MM, HEAT

VP-9 D CH, ROCKET, BD ELEMENT



**BULGARIAN CARTRIDGE, 73-MM, ROCKET, HEAT,  
PG-9V**



Ordnance used with:  
PG-9, 73MM, HEAT  
VP-9 G CH, ROCKET, PI ELEMENT  
MDL. UNKNOWN, PG-9, 73MM, RKT MOTOR  
346 E, 73MM, PROPELLING CHARGE  
PG-9P, 73MM, EXPELLING CHARGE  
PG-9P, 73MM, PROPELLING CHARGE  
UNDESIGNATED, WARHEAD, 73MM, HEAT, FOR PG-9

---

**BULGARIAN CARTRIDGE, 73-MM, ROCKET, HEAT,  
PG-9VN**



Ordnance used with:  
PG-9N, 73MM, HEAT  
VP-9 G CH, ROCKET, PI ELEMENT  
MDL. UNKNOWN, PG-9, 73MM, RKT MOTOR  
346 E, 73MM, PROPELLING CHARGE  
PG-9P, 73MM, EXPELLING CHARGE  
PG-9P, 73MM, PROPELLING CHARGE  
PG-9N, WARHEAD, 73-MM, HEAT

## **BULGARIAN PROPELLING CHARGE, ROCKET CARTRIDGE, 73-MM, PG-15P**

Ordnance used with:

PG-15V, CARTRIDGE, 73MM, HEAT

PG-9, 73MM, HEAT

PG-15VN, CARTRIDGE, 73MM, HEAT

PG-9N, 73MM, HEAT

MDL. UNKNOWN, PG-9, 73MM, RKT MOTOR

PG-9, 73MM, PRACTICE

PG-15, CARTRIDGE, 73-MM, PRAC



---

## **BULGARIAN ROCKET, 73-MM, HEAT, PG-9N**

Ordnance used with:

PG-15VN, CARTRIDGE, 73MM, HEAT

VP-9 G CH, ROCKET, PI ELEMENT

MDL. UNKNOWN, PG-9, 73MM, RKT MOTOR

PG-9VN, 73MM, CARTRIDGE, ROCKET, HEAT

346 E, 73MM, PROPELLING CHARGE

PG-9P, 73MM, EXPPELLING CHARGE

PG-9P, 73MM, PROPELLING CHARGE





**CHINESE ROCKET, 85MM, HEAT, TYPE 69-I W/TYPE 1 FUZE**

Ordnance used with:  
TYPE 1, ROCKET, PIBD



**BULGARIAN ROCKET EXPELLING CHARGE, PG-7P**



Ordnance used with:  
PG-7VL, 93MM, HEAT-T



## CHINESE EXPPELLING CHARGE, MODEL UNKNOWN (FOR PG-9 TYPE)

Ordnance used with:  
TYPE 69-1, 85-MM, HEAT  
TYPE 69-1, 85MM, HEAT

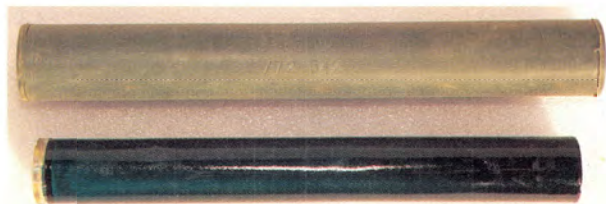

## U.S.S.R. ROCKET WARHEAD, 57-MM, HE-FRAG, S-5MO

Ordnance used with:  
UB-16-57, UMVP, LAUNCHER, ROCKET, AIRCRAFT  
UB-32A1, LAUNCHER, ROCKET, AIRCRAFT (57-MM)  
V-5K, ROCKET, PD, A-TO-S  
C-5MO, 57-MM, HE/FRAG, A-TO-S  
S-5MO, 57-MM, HE/FRAG, A-TO-S  
S-5MO, MOTOR, 57 MM, SOLID PROPELLENT, A-TO-S

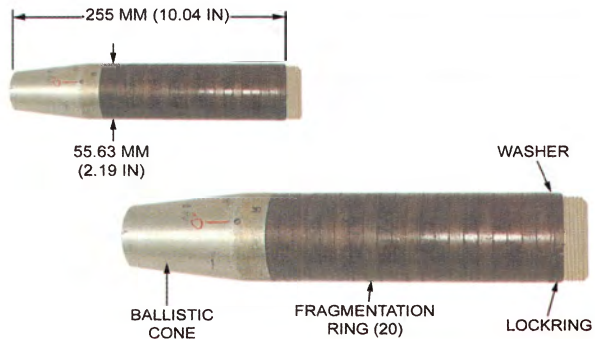



### U.S.S.R. ROCKET MOTOR, 57-MM, SOLID PROPELLANT, AIR-TO-SURFACE, S-5KO

Ordnance used with:  
UB-16-57, UMVP, LAUNCHER, ROCKET, AIRCRAFT  
UB-32A1, LAUNCHER, ROCKET, AIRCRAFT (57-MM)  
S-5KO, 57-MM, WARHEAD, HEAT-FRAG, A-TO-S

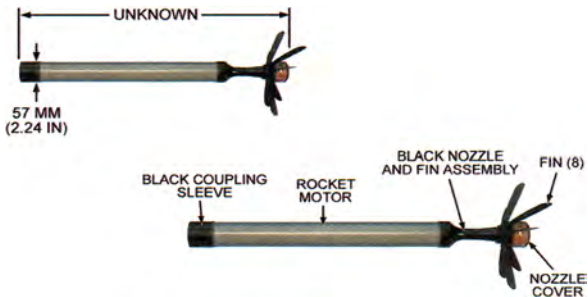

### U.S.S.R. ROCKET MOTOR, 57-MM, SOLID PROPELLANT, MODEL UNKNOWN

Ordnance used with:  
S-5-OB, 57-MM, WARHEAD, ILLUMINATION, A-TO-S  
S-5-01, 57-MM, ILLUMINATION, A-TO-S  
S-5-OB, 57-MM, ILLUMINATION, A-TO-S

"Image from the Russian Arms Catalog,  
Vol. VII, reproduced with permission from  
Military Parade Publishing House."

## U.S.S.R. ROCKET MOTOR, 57-MM, SOLID PROPELLANT, S-5KP

Ordnance used with:

UB-16-57, UMVP, LAUNCHER, ROCKET, AIRCRAFT  
UB-32A1, LAUNCHER, ROCKET, AIRCRAFT (57-MM)  
S-5KP, 57-MM, HEAT/FRAG, A-TO-S  
S-5KP, 57-MM, WARHEAD, HEAT/FRAG, A-TO-S



## U.S.S.R. ROCKET MOTOR, 57-MM, SOLID-PROPELLANT, S-5MO

Ordnance used with:

UB-16-57, UMVP, LAUNCHER, ROCKET, AIRCRAFT  
UB-32A1, LAUNCHER, ROCKET, AIRCRAFT (57-MM)  
C-5MO, 57-MM, HE/FRAG, A-TO-S  
S-5MO, 57-MM, HE/FRAG, A-TO-S  
S-5MO, 57-MM, WARHEAD, HEAT/FRAG, A-TO-S

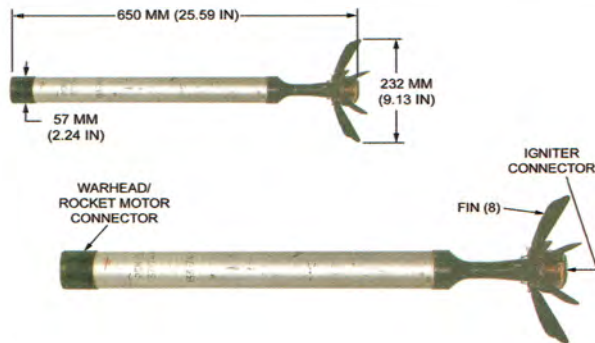

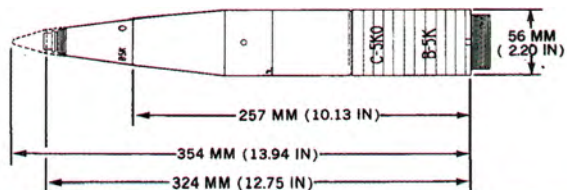

### U.S.S.R. ROCKET WARHEAD, 57-MM, HEAT/FRAG MODEL S-5KO

Ordnance used with:

UB-16-57, UMVP, LAUNCHER, ROCKET, AIRCRAFT  
 UB-32A1, LAUNCHER, ROCKET, AIRCRAFT (57-MM)  
 V-5K, ROCKET, PD, A-TO-S  
 V-5M1, ROCKET, PSD  
 KO-7V, 57MM, CARTRIDGE, HEAT-FRAG

### U.S.S.R. ROCKET WARHEAD, 57-MM, HEAT/FRAG, S-5KP



Ordnance used with:

UB-16-57, UMVP, LAUNCHER, ROCKET, AIRCRAFT  
 UB-32A1, LAUNCHER, ROCKET, AIRCRAFT (57-MM)  
 S-5KP, 57-MM, HEAT/FRAG, A-TO-S  
 S-5KP, MOTOR, 57-MM, SOLID PROPELLANT, A-TO-S  
 V-5KP1, ROCKET, PIBD, A-TO-S

## U.S.S.R. ROCKET, 57-MM, AIR-TO-SURFACE, HEAT/ FRAG, S-5KP

Ordnance used with:

UB-16-57, UMVP, LAUNCHER, ROCKET, AIRCRAFT

UB-32A1, LAUNCHER, ROCKET, AIRCRAFT (57-MM)

UB-32A, LAUNCHER, ROCKET, AIRCRAFT (57-MM)

S-5KP, 57-MM, WARHEAD, HEAT/FRAG, A-TO-S

S-5KP, MOTOR, 57-MM, SOLID PROPELLANT, A-TO-S

V-5KP1, ROCKET, PIBD, A-TO-S

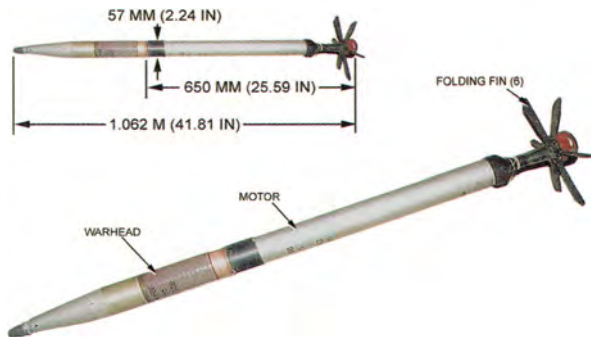

## U.S.S.R. ROCKET, 57-MM, CHAFF, S-5PB

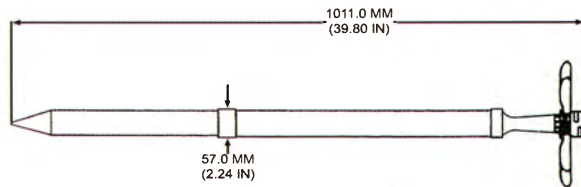



### U.S.S.R. ROCKET, 57-MM, HE, S-5M

Ordnance used with:

UB-16-57, UMVP, LAUNCHER, ROCKET, AIRCRAFT  
 UB-32A1, LAUNCHER, ROCKET, AIRCRAFT (57-MM)  
 UB-32A, LAUNCHER, ROCKET, AIRCRAFT (57-MM)  
 UB-16-57-U, 57-MM, LAUNCHER, RKT  
 V-5M1, ROCKET, PDSD  
 UB-16-57-U, 57 MM, LAUNCHER, ROCKET, 16 SHOT

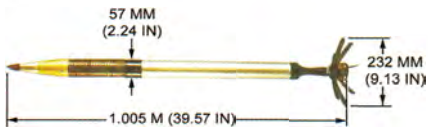

### U.S.S.R. ROCKET, 57-MM, HE-FRAG, S-5MO

Ordnance used with:

UB-16-57, UMVP, LAUNCHER, ROCKET, AIRCRAFT  
 UB-32A1, LAUNCHER, ROCKET, AIRCRAFT (57-MM)  
 V-5K, ROCKET, PD, A-TO-S  
 V-5M1, ROCKET, PDSD  
 S-5MO, 57-MM, WARHEAD, HEAT/FRAG, A-TO-S  
 S-5MO, MOTOR, 57 MM, SOLID PROPELLENT, A-TO-S

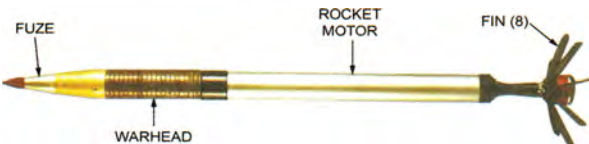

## U.S.S.R. ROCKET, 57-MM, HEAT/FRAG, S-5KPB

Ordnance used with:

UB-16-57, UMVP, LAUNCHER, ROCKET, AIRCRAFT  
UB-32A1, LAUNCHER, ROCKET, AIRCRAFT (57-MM)  
V-5KP1, ROCKET, PIBD, A-TO-S

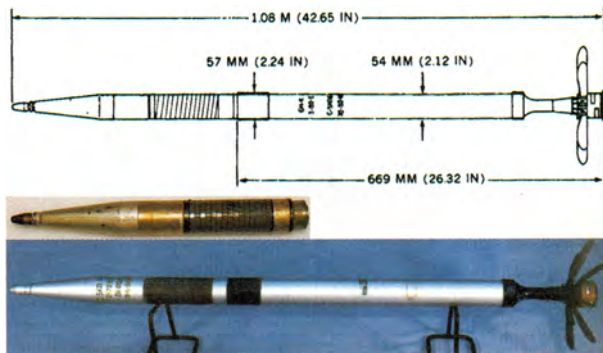

## U.S.S.R. ROCKET, 57-MM, ILLUMINATION, S-5-OB

Ordnance used with:

S-5-OB, 57-MM, WARHEAD, ILLUMINATION, A-TO-S  
VB-5, ROCKET, NOSE, A-TO-S  
S-5-OB, MOTOR, 57-MM, SOLID PROPELLANT, AIR-S...

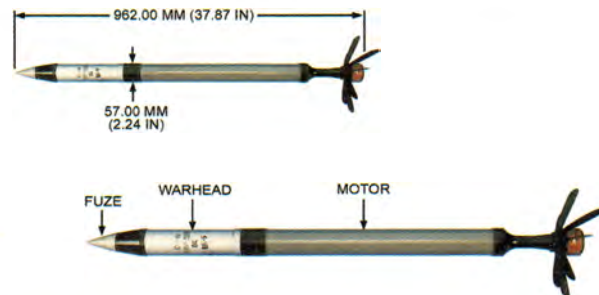

"Image from the Russian Arms Catalog,  
Vol. VII, reproduced with permission from  
Military Parade Publishing House."

## U.S.S.R. ROCKETS, 57-MM, HEAT, S-5K AND S-5K1



Ordnance used with:  
UB-16-57-U, 57-MM, LAUNCHER, RKT  
V-5K, ROCKET, PD, A-TO-S  
MP-4, PROJECTILE, PD  
UB-16-57-U, 57 MM, LAUNCHER, ROCKET, 16 SHOT

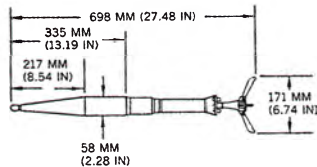

## U.S.S.R. GRENADE, 58-MM, ROCKET-PROPELLED, HEAT-FS-T, PG-16

Ordnance used with:  
VP-16 G CH, ROCKET, PIBD, PI ELEMENT  
PG-16P, 57MM, EXPELLING CHARGE, RKT  
VP-9 D CH, ROCKET, PIBD, BASE DETONATING ELEMENT  
PG-16V, 58MM, CARTRIDGE, HEAT

N.E.W. 800.00 G

## YUGOSLAV ROCKET, 64-MM, HEAT, M80

Ordnance used with:  
RBR M80, 64-MM, RKT SYSTEM, HEAT

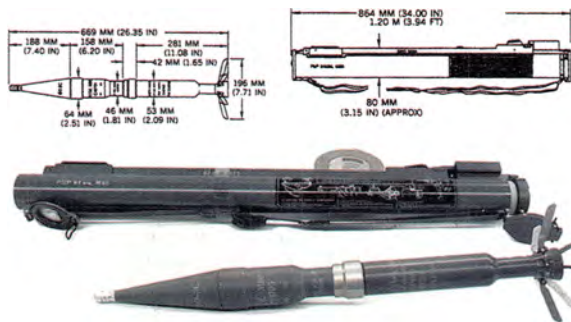

## U.S. ROCKET WARHEAD, 2.75-IN, HE, M261

Ordnance used with:  
LAU-130/A, LAUNCHER, RKT  
LAU-131/A, LAUNCHER, RKT  
LAU-3/A, LAUNCHER, RKT  
LAU-32/A, LAUNCHER, RKT  
LAU-32A/A, LAUNCHER, RKT  
LAU-3A/A, LAUNCHER, RKT  
LAU-3B/A, LAUNCHER, RKT

N.E.W. 34.18 OZ

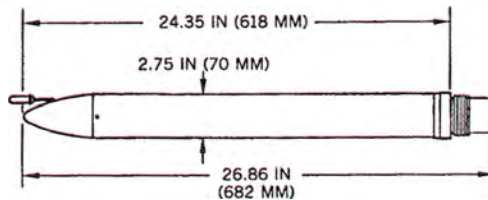

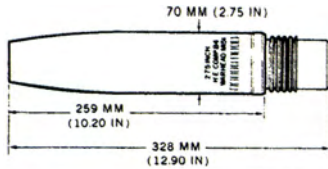

## U.S. ROCKET WARHEAD, 2.75-IN, HE-FRAG, M151

Ordnance used with:

LAU-130/A, LAUNCHER, RKT  
 LAU-131/A, LAUNCHER, RKT  
 LAU-3/A, LAUNCHER, RKT  
 LAU-32/A, LAUNCHER, RKT  
 LAU-32A/A, LAUNCHER, RKT  
 LAU-3A/A, LAUNCHER, RKT  
 LAU-3B/A, LAUNCHER, RKT

N.E.W. 1.00 KG

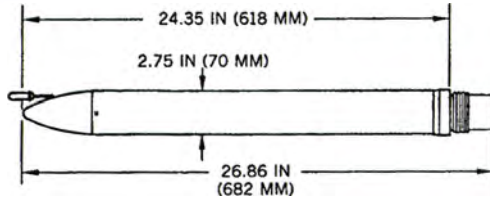

## U.S. ROCKET WARHEAD, FLECHETTE, 2.75-IN, HE, M255A1

Ordnance used with:

LAU-130/A, LAUNCHER, RKT  
 LAU-131/A, LAUNCHER, RKT  
 LAU-3/A, LAUNCHER, RKT  
 LAU-32/A, LAUNCHER, RKT  
 LAU-32A/A, LAUNCHER, RKT  
 LAU-3A/A, LAUNCHER, RKT  
 LAU-3B/A, LAUNCHER, RKT

## U.S.S.R. ROCKET, 70-MM, HEAT, PG-7M

Ordnance used with:  
VP-7M, ROCKET, PIBD  
PG-7VM, 70MM, CARTRIDGE, HEAT  
PG-7VM, 70MM, CARTRIDGE, HEAT

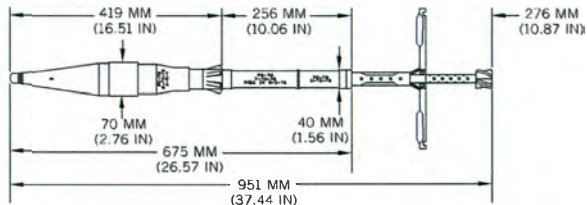

N.E.W. 489.00 G

## U.S.S.R. ROCKET, 70-MM, GROUND-TO-GROUND, HEAT, PG-7S

Ordnance used with:  
PG-7P, EJECTION CHARGE FOR PG-7-SERIES ROCKETS  
VP-7M G CH, FUZE, ROCKET, PI ELEMENT  
VP-7M D CH, FUZE, ROCKET, BASE DETONATING ELEMENT



## BULGARIAN CARTRIDGE, 73-MM, ROCKET, PRACTICE, PG-15



Ordnance used with:  
MDL. UNKNOWN, PG-9, 73MM, RKT MOTOR  
PG-9, 73MM, PRACTICE  
PG-15P, 73MM, PROPELLING CHARGE  
PG-9, WARHEAD, 73-MM, PRAC



## BULGARIAN ROCKET, 73-MM, HEAT, PG-9

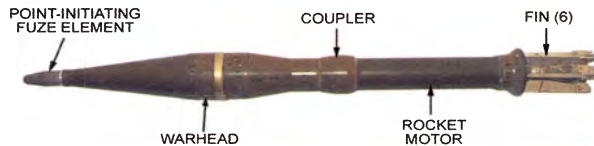

Ordnance used with:  
PG-15V, CARTRIDGE, 73MM, HEAT  
VP-9 G CH, ROCKET, PI ELEMENT  
PG-9V, 73MM, CARTRIDGE, ROCKET, HEAT  
MDL. UNKNOWN, PG-9, 73MM, RKT MOTOR  
346 E, 73MM, PROPELLING CHARGE  
PG-9P, 73MM, EXPPELLING CHARGE  
PG-9P, 73MM, PROPELLING CHARGE

**BULGARIAN WARHEAD, 73-MM, ROCKET, HEAT,  
PG-9N**

Ordnance used with:

PG-15VN, CARTRIDGE, 73MM, HEAT

PG-9N, 73MM, HEAT

VP-9 G CH, ROCKET, PI ELEMENT

MDL. UNKNOWN, PG-9, 73MM, RKT MOTOR

PG-9VN, 73MM, CARTRIDGE, ROCKET, HEAT

346 E, 73MM, PROPELLING CHARGE

PG-9P, 73MM, EXPELLING CHARGE



---

**BULGARIAN WARHEAD, 73MM, ROCKET, HEAT, PG-9**

Ordnance used with:

PG-15V, CARTRIDGE, 73MM, HEAT

PG-9, 73MM, HEAT

VP-9 G CH, ROCKET, PI ELEMENT

PG-9V, 73MM, CARTRIDGE, ROCKET, HEAT

MDL. UNKNOWN, PG-9, 73MM, RKT MOTOR

VP-9 D CH, ROCKET, BD ELEMENT



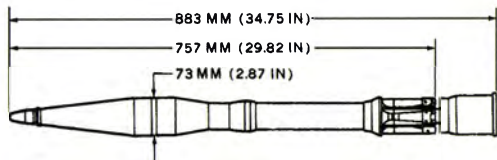

## U.S.S.R. CARTRIDGE, 73-MM, HEAT-T, PG-9, PG-9S & PG-9 PRACTICE

Ordnance used with:  
 PG-15, CARTRIDGE, 73-MM, HEAT-T  
 VP-9, ROCKET, PIBD

N.E.W. 335.00 G

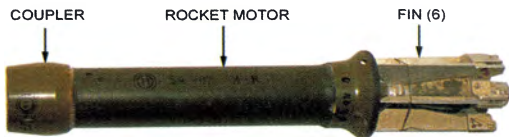

## BULGARIAN ROCKET MOTOR, 73-MM, PG-9

Ordnance used with:  
 PG-15V, CARTRIDGE, 73MM, HEAT  
 PG-9, 73MM, HEAT  
 PG-15VN, CARTRIDGE, 73MM, HEAT  
 PG-9N, 73MM, HEAT  
 PG-9V, 73MM, CARTRIDGE, ROCKET, HEAT  
 PG-9VN, 73MM, CARTRIDGE, ROCKET, HEAT  
 346 E, 73MM, PROPELLING CHARGE

N.E.W. 495.00 G

## CHINESE ROCKET, 75-MM, APERS, BOUNDING, TYPE 69

Ordnance used with:  
MJ-7, FUZE, ROCKET, PI  
DREOI, FUZE, ROCKET, PI

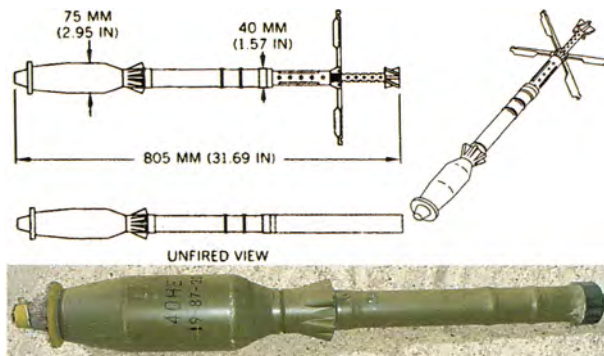

## U.S.S.R. ROCKET MOTOR, 80-MM, SOLID PROPELLANT, S-8-OF

Ordnance used with:  
S-8-OF, 80-MM, HE/FRAG, A-TO-S  
V-8, ROCKET, PD, A-TO-S  
S-8-OF, WARHEAD, 80-MM, HE/FRAG, A-TO-S

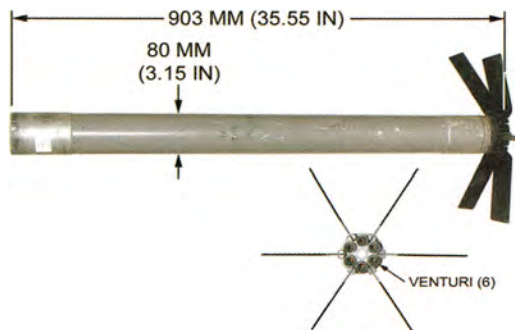

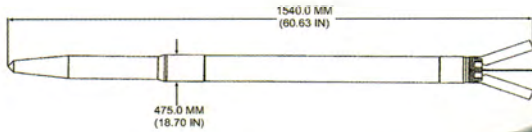

**U.S.S.R. ROCKET, 80-MM, APHE, S8BM**



**U.S.S.R. ROCKET, 80-MM, CHAFF, S8PM**

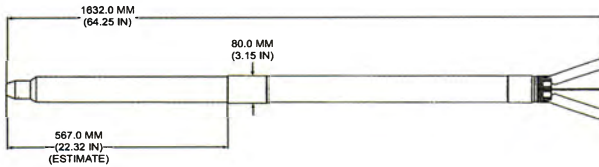

## U.S.S.R. ROCKET, 80-MM, FAE, S8DM

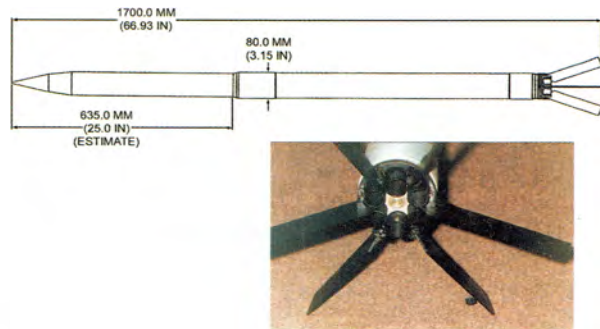

## U.S.S.R. ROCKET, 80-MM, FLECHETTE, S8ASM

Ordnance used with:

B-8M, LAUNCHER, ROCKET, 20-SHOT

B-8M1, LAUNCHER, ROCKET, 20-SHOT

B-8V20-A, LAUNCHER, ROCKET, 20-SHOT

B-8V20A, LAUNCHER, ROCKET, 20-SHOT

B-8V7, LAUNCHER, 7-SHOT

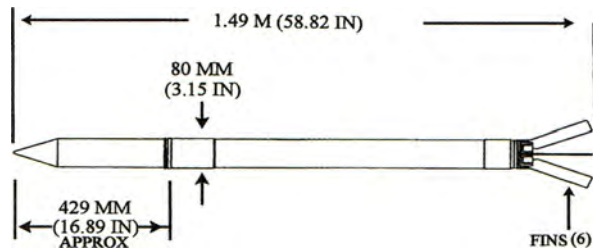

## U.S.S.R. ROCKET, 80-MM, HE/FRAG, S-8-OF

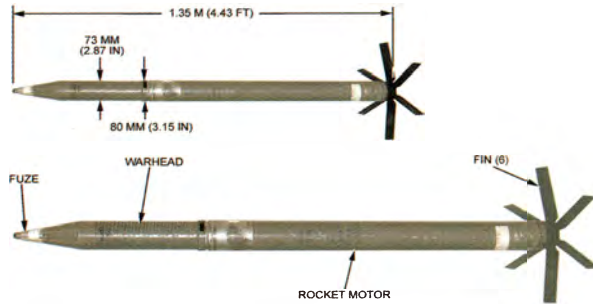

Ordnance used with:  
V-8, ROCKET, PD, A-TO-S  
S-8-OF, WARHEAD, 80-MM, HE/FRAG, A-TO-S  
S-8-OF, 80-MM, MOTOR, SOLID PROPELLANT, A-TO-S

N.E.W. 10.04 KG

## U.S.S.R. ROCKET, 80-MM, ILLUMINATION, S80M

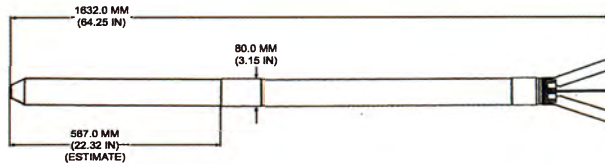

## U.S.S.R. WARHEAD, 80-MM, HE/FRAG, S-8-OF

Ordnance used with:

S-8-OF, 80-MM, HE/FRAG, A-TO-S

V-8, ROCKET, PD, A-TO-S

S-8-OF, 80-MM, MOTOR, SOLID PROPELLANT, A-TO-S



N.E.W. 1.37 KG

## YUGOSLAV ROCKET SYSTEM, 64-MM, HEAT, RBR M80

Ordnance used with:

M80, 64MM, HEAT

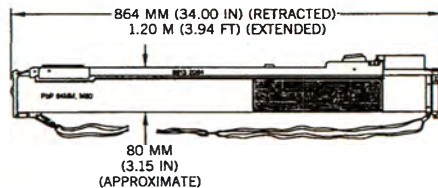

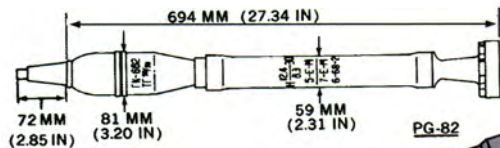

### U.S.S.R. ROCKET, 82 MM, HE, OG82

Ordnance used with:  
 GK-1, FUZE, PROJECTILE, PD  
 GK-2, FUZE, PROJECTILE, PD  
 GK-2M, FUZE, PROJECTILE, PD  
 GK-662, 82 MM, WARHEAD, HEAT



### U.S.S.R. ROCKET, 80-MM, HEAT/FRAG, S-8KO

Ordnance used with:  
 9-K1-608, ROCKET, BASE ELEMENT, A-TO-S  
 B-8M, LAUNCHER, ROCKET, 20-SHOT  
 B-8M1, LAUNCHER, ROCKET, 20-SHOT  
 B-8V20-A, LAUNCHER, ROCKET, 20-SHOT  
 B-8V20A, LAUNCHER, ROCKET, 20-SHOT  
 B-8V7, LAUNCHER, 7-SHOT  
 V-5KP1, ROCKET, PIBD, A-TO-S  
 N.E.W. 1.00 KG

## U.S.S.R. ROCKET, 80-MM, HEAT/FRAG, S-8KOM

Ordnance used with:

9-K1-608, ROCKET, BASE ELEMENT, A-TO-S  
B-8M, LAUNCHER, ROCKET, 20-SHOT  
B-8M1, LAUNCHER, ROCKET, 20-SHOT  
B-8V20-A, LAUNCHER, ROCKET, 20-SHOT  
B-8V20A, LAUNCHER, ROCKET, 20-SHOT  
B-8V7, LAUNCHER, 7-SHOT  
V-5KP1, ROCKET, PIBD, A-TO-S

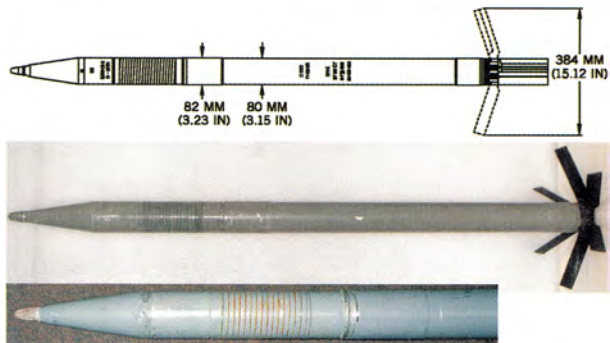

## BULGARIAN ROCKET, 85-MM, HEAT, PG7

Ordnance used with:

VP-7M, ROCKET, PIBD  
PG-7P, EJECTION CHARGE FOR PG-7-SERIES ROCKETS  
VP-7M D CH, FUZE, ROCKET, BASE DETONATING ELEMENT  
VP-7M G CH, FUZE, ROCKET, PI ELEMENT  
PG-7, RKT MOTOR

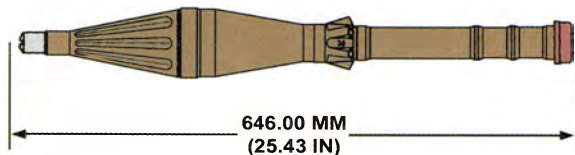

N.E.W. 603.44 G

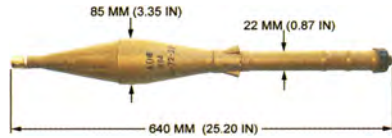

## CHINESE ROCKET, 85-MM, HEAT, TYPE 69-1

Ordnance used with:  
MDL. UNKNOWN, EXPPELLING CHARGE FOR TYPE 69-1  
FUZE, ROCKET, PIBD, TYPE 69-1

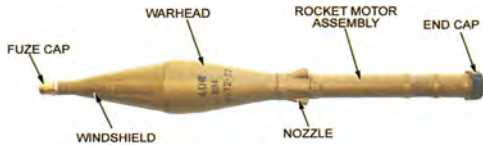

## IRANIAN ROCKET, HEAT-T, NADER

**PAKISTANI ROCKET, 85MM, HEAT, P1 MK1**



**U.S.S.R. ROCKET, 85-MM, HEAT, PG-7**

Ordnance used with:  
VP-7, ROCKET, PIBD  
PG-7P, EJECTION CHARGE FOR PG-7-SERIES ROCKETS



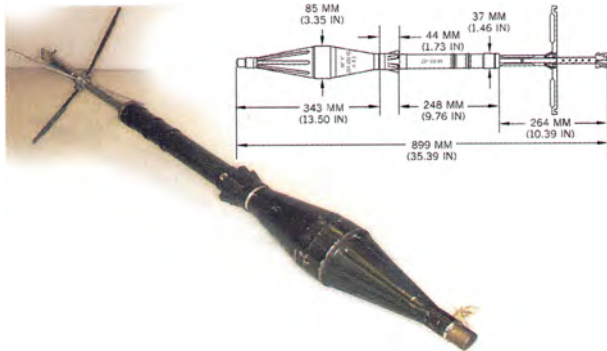

### U.S.S.R. ROCKET, 85-MM, HEAT-T, MODEL PG-7G

Ordnance used with:  
UNDESIGNATED, GRENADE, PIBD

N.E.W. 770.00 G

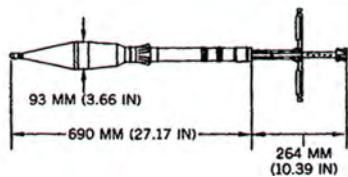

### U.S.S.R. GRENADE, 93-MM, HEAT-T, ROCKET PROPELLED, PG-7VL

Ordnance used with:  
PG-7L, 94MM, HEAT  
PG-7P, EXPELLING CHARGE



## CHINESE ROCKET, 107-MM, HE, TYPE 63-2

Ordnance used with:  
MJ-1, ROCKET, PD

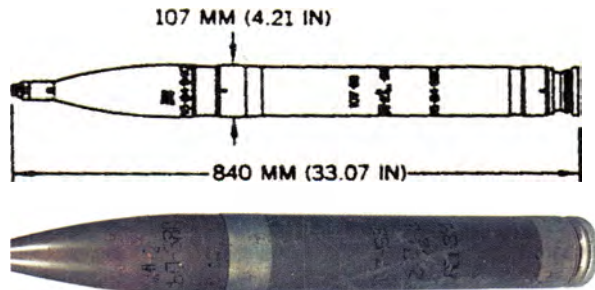

N.E.W. 1.30 KG

## CHINESE ROCKET, 107-MM, HE-FRAG, SPIN-STABILIZED, TYPE 63

Ordnance used with:  
MD-21, ROCKET, PROX.  
TYPE 1, ROCKET, PD

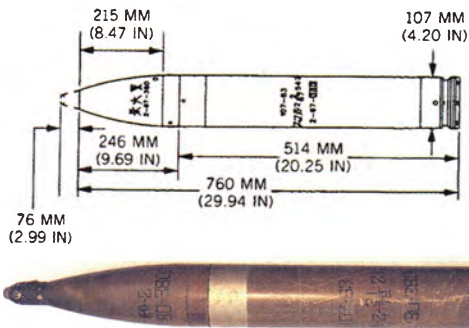

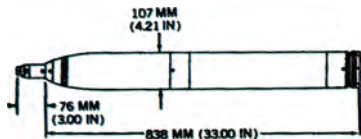

### CHINESE ROCKET, 107-MM, INCENDIARY, TYPE 63-1

Ordnance used with:  
MD-21, ROCKET, PROX.  
MJ-1, ROCKET, PD  
TYPE 63-1, WARHEAD, 107 MM, INCENDIARY

---

### NORTH KOREAN ROCKET, 107MM, HE, R107



Ordnance used with:  
TYPE 107, ROCKET, PD  
MDL. UNKNOWN, ROCKET, FOR R107

**U.S.S.R. ROCKET, 122-MM, AIR-TO-SURFACE, HE,  
S-13D**

Ordnance used with:  
B-13L, LAUNCHER, ROCKET, 5 SHOT

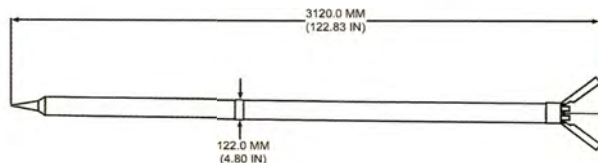

**U.S.S.R. ROCKET, 122-MM, HE, 9M28F**

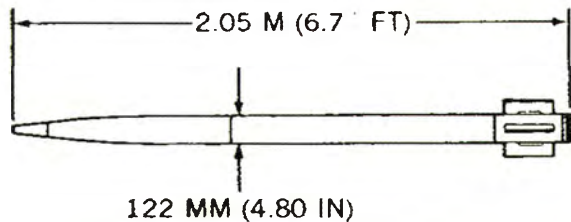

N.E.W. 6.00 KG

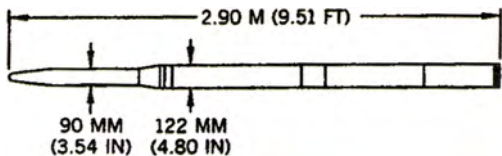

**U.S.S.R. ROCKET, 122-MM, HE, S-13**

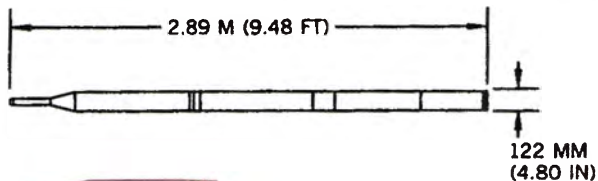

**U.S.S.R. ROCKET, 122-MM, HE, S-13-OF**



Ordnance used with:  
B-13L, LAUNCHER, ROCKET, 5 SHOT

N.E.W. 7.00 KG

## U.S.S.R. ROCKET, 122-MM, HE, S-13-T

Ordnance used with:  
B-13L, LAUNCHER, ROCKET, 5 SHOT

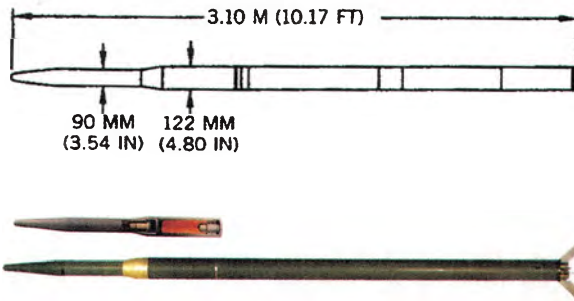

N.E.W. 4.50 KG

## U.S.S.R. ROCKET, 122-MM, HE-FRAG, FIN & SPIN-STABILIZED, 9M22U (9-FOOT)

Ordnance used with:  
MRV-U, ROCKET, PD  
9E210, ROCKET, PD  
M-210F, WARHEAD, 122-MM, HE-FRAG  
M-210FM, RKT WARHEAD, 122-MM, HE-FRAG  
MRV-U, ROCKET, PD

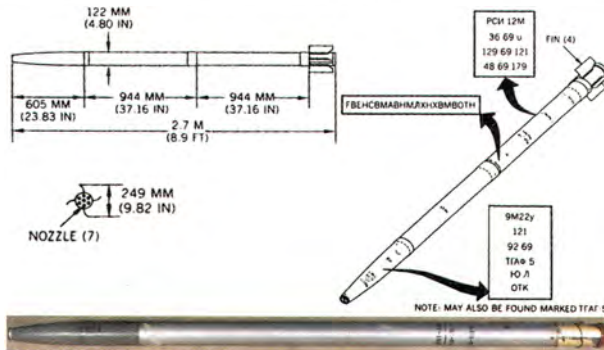



### U.S.S.R. ROCKET, 122-MM, HE-FRAG, FIN- & SPIN-STABILIZED, 9M22M (6-FOOT)

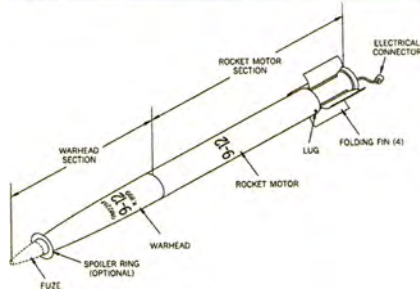

Ordnance used with:  
 DKZ-B, ROCKET, NOSE, PD  
 MRV, RKT FUZE, PD  
 MRV-42M, ROCKET, PD  
 MRV-U, ROCKET, PD  
 M-210F, WARHEAD, 122-MM, HE-FRAG  
 M-210FM, RKT WARHEAD, 122-MM, HE-FRAG  
 MRV-U, ROCKET, PD

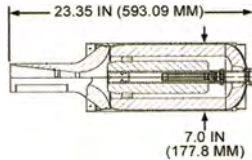

### U.S. GUIDED MISSILE ROCKET MOTOR, M120E4

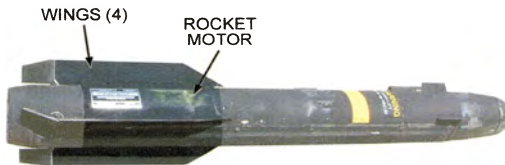

Ordnance used with:  
 AGM-114K, GUIDED MISSILE, A-TO-S (HELLFIRE II)  
 AGM-114L, GUIDED MISSILE, A-TO-S (LONGBOW)  
 AGM-114M, GUIDED MISSILE, AIR-TO-SURFACE, HEL...  
 AGM-114N, GUIDED MISSILE, HELLFIRE II

N.E.W. 21.96 LB

## U.S.S.R. ROCKET, 64-MM, HEAT, MODEL PG-18

Ordnance used with:  
V659, ROCKET, BD  
VP-18 D CH, ROCKET, BD ELEMENT

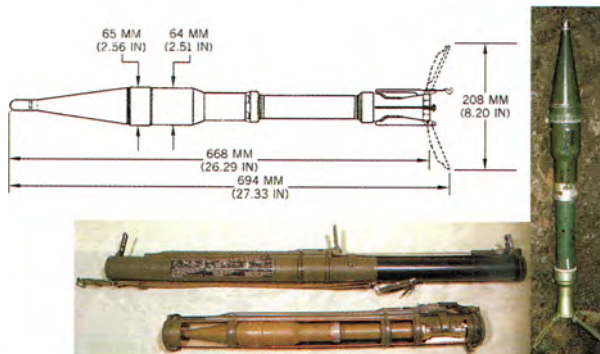

## U.S.S.R. ROCKET WARHEAD, 220-MM, AT, MINE DISPENSING, 9N128K2

Ordnance used with:  
9M27K2, 220 MM, CARGO  
PGMDM, LANDMINE, AT  
PTM-1, LANDMINE, AT  
PTM-1S, LANDMINE, AT



"Image from Russian Arms Catalog, Vol. 7, reproduced with Permission from Military Parade Publishing House."

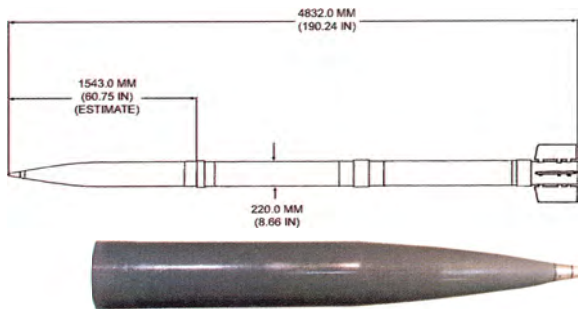

"Image from Russian Arms Catalog, Vol. 7, reproduced with Permission from Military Parade Publishing House."

## U.S.S.R. ROCKET WARHEAD, 220-MM, HE, 9N128F

Ordnance used with:  
 MRV-U, ROCKET, PD  
 9M27F, 220MM, HE  
 MRV-U, ROCKET, PD

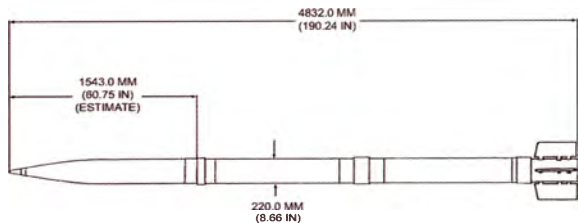

## U.S.S.R. ROCKET, 220-MM, HE, 9M27F

Ordnance used with:  
 MRV-U, ROCKET, PD  
 9N128F, WARHEAD, 220MM, HE  
 MRV-U, ROCKET, PD



## U.S.S.R. ROCKET, 220-MM, HE, 9M27K1

Ordnance used with:  
9N128K1, WARHEAD, 220MM, CARGO

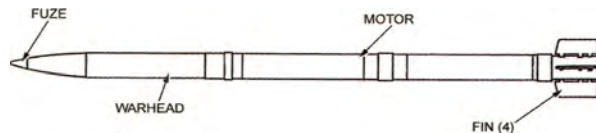

## U.S.S.R. ROCKET, SURFACE-TO-SURFACE, 220-MM, AT, MINE DISPENSING, 9M27K2

Ordnance used with:  
PGMDM, LANDMINE, AT  
PTM-1, LANDMINE, AT  
PTM-1S, LANDMINE, AT  
9N128K2, WARHEAD, 220MM, CARGO

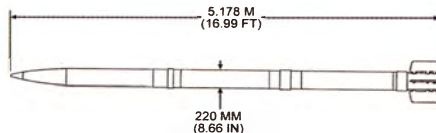

**U.S.S.R. ROCKET, SURFACE-TO-SURFACE, APERS, MINE DISPENSING, 9M27K3**

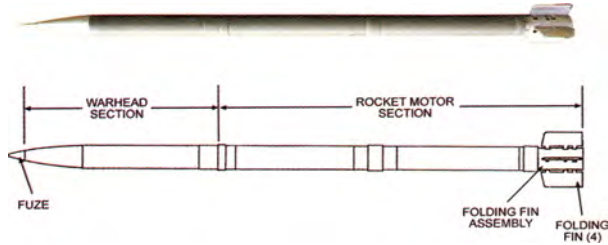

**U.S.S.R. ROCKET, 240-MM, AIRCRAFT, HE, MODEL S-24**

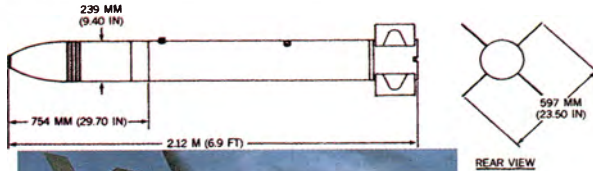

Ordnance used with:  
V-24A, PD, RKT  
9-A-682, ROCKET, PROXIMITY, A-TO-S  
RV-24, ROCKET, PROXIMITY, A-TO-S

## BULGARIAN PROPELLING CHARGE, 73-MM, PG-9P

Ordnance used with:

PG-9, 73MM, HEAT

PG-9N, 73MM, HEAT

346-E, 73MM, CARTRIDGE, HE (TEARDROP)

346E, 73MM, CARTRIDGE, HE (TEARDROP)

OG-9, 73MM, CARTRIDGE, HE (TEARDROP)

OG-9/F, 73MM, CARTRIDGE, HE (TEARDROP)

PG-9V, 73MM, CARTRIDGE, ROCKET, HEAT

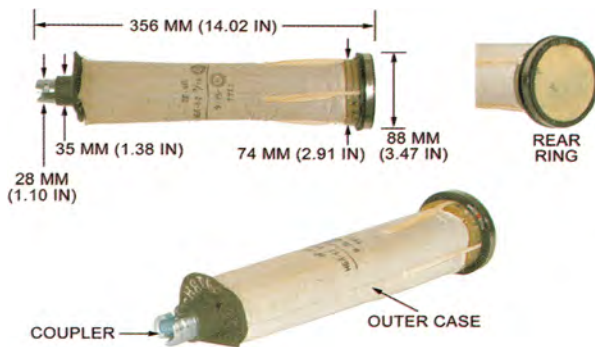

***THIS PAGE INTENTIONALLY LEFT BLANK***

**U.K. GUIDED MISSILE, SURFACE-TO-AIR, SURFACE-TO-SURFACE, K103A1 MK 2, BLOWPIPE**

Ordnance used with:  
LAUNCH TUBE, K103A1, BLOWPIPE



---

**U.S. GUIDED MISSILE STARTER CARTRIDGE FOR ENGINE, TURBOFAN, F107-WR-101**

Ordnance used with:  
AGM-86C, AIR-TO-SURFACE, CALCM  
OTL, PRACTICE ALCM, AGM-86C  
AGM-86D, CALCM  
UNDESIGNATED, AFT SECTION, AGM-86 SERIES

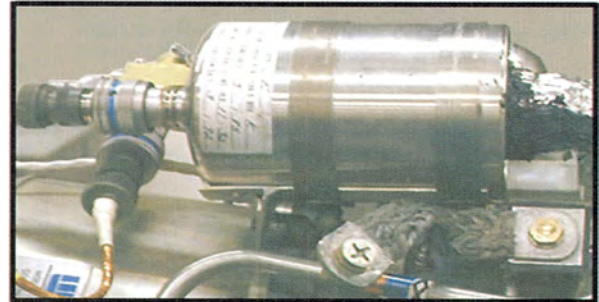

## U.S. GUIDED MISSILE SWITCH, ROTARY, SWU-58/A

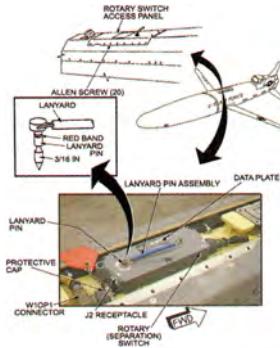

Ordnance used with:  
FMU-139A/B, NOSE & TAIL, IMPACT  
AGM-86C, AIR-TO-SURFACE, CALCM  
OTL, PRACTICE ALCM, AGM-86C  
AGM-86D, CALCM  
UNDESIGNATED, CENTER SECTION, F/AGM-86D

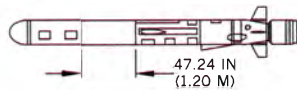

ANTISHIP VERSION  
BLAST-EFFECT WARHEAD

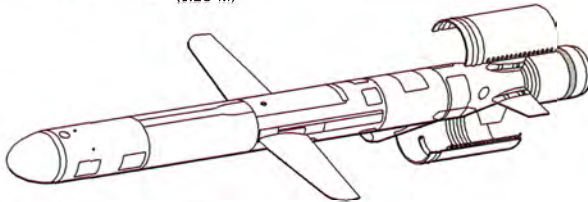

## U.S. GUIDED MISSILE WARHEADS, CONVENTIONAL (FOR RGM-/UGM-109-SERIES TOMAHAWK) (ANTISHIP VERSION BLAST EFFECT WARHEAD)

Ordnance used with:  
RGM-109B-1, GUIDED MISSILE, S-TO-S (TOMAHAWK)  
RGM-109B-3, GUIDED MISSILE, S-TO-S (TOMAHAWK)  
RGM-109B-4, GUIDED MISSILE, S-TO-S, (TOMAHAWK)  
RGM-109C-1, GUIDED MISSILE, S-TO-S (TOMAHAWK)  
RGM-109C-3, GUIDED MISSILE, S-TO-S (TOMAHAWK)  
RGM-109C-4, GUIDED MISSILE, S-TO-S (TOMAHAWK)  
RGM-109D-3, GUIDED MISSILE, S-TO-S (TOMAHAWK)

**U.S. GUIDED MISSILE WARHEADS, CONVENTIONAL  
(FOR RGM-/UGM-109-SERIES TOMAHAWK) (LAND-  
ATTACK VERSION BLAST EFFECT WARHEAD)**

Ordnance used with:

- RGM-109B-1, GUIDED MISSILE, S-TO-S (TOMAHAWK)
- RGM-109B-3, GUIDED MISSILE, S-TO-S (TOMAHAWK)
- RGM-109B-4, GUIDED MISSILE, S-TO-S, (TOMAHAWK)
- RGM-109C-1, GUIDED MISSILE, S-TO-S (TOMAHAWK)
- RGM-109C-3, GUIDED MISSILE, S-TO-S (TOMAHAWK)
- RGM-109C-4, GUIDED MISSILE, S-TO-S (TOMAHAWK)
- RGM-109D-3, GUIDED MISSILE, S-TO-S (TOMAHAWK)

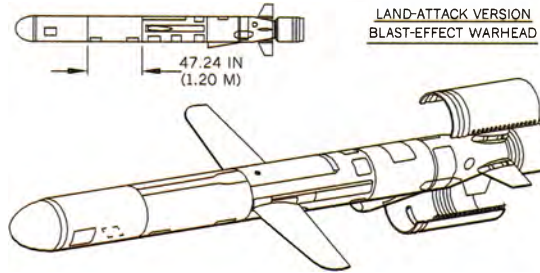

**U.S. GUIDED MISSILE WARHEADS, CONVENTIONAL  
(FOR RGM-/UGM-109-SERIES TOMAHAWK) (LAND-  
ATTACK VERSION SUBMUNITION LOADED)**

Ordnance used with:

- RGM-109B-1, GUIDED MISSILE, S-TO-S (TOMAHAWK)
- RGM-109B-3, GUIDED MISSILE, S-TO-S (TOMAHAWK)
- RGM-109B-4, GUIDED MISSILE, S-TO-S, (TOMAHAWK)
- RGM-109C-1, GUIDED MISSILE, S-TO-S (TOMAHAWK)
- RGM-109C-3, GUIDED MISSILE, S-TO-S (TOMAHAWK)
- RGM-109C-4, GUIDED MISSILE, S-TO-S (TOMAHAWK)
- RGM-109D-3, GUIDED MISSILE, S-TO-S (TOMAHAWK)

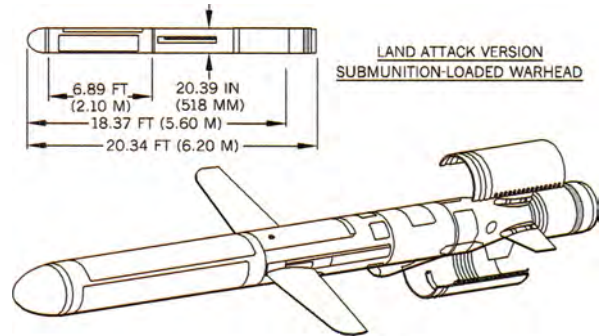



**U.S.S.R. GUIDED MISSILE, SURFACE-TO-SURFACE,  
TRAINING, AT-2C (SWATTER)**



**CHINESE GUIDED MISSILE, SURFACE-TO-AIR, HN-5**



**U.S. GUIDED MISSILE LAUNCHERS, SURFACE-TO-AIR, FIM-92A, FIM-92B, FIM-92C, FIM-92D, AND FIM-92 E (STINGER)**

Ordnance used with:  
T61, ELEC. DET.

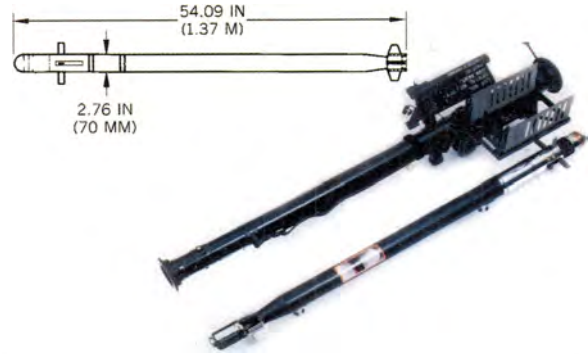

N.E.W. 11.30 LB

**U.S. GUIDED MISSILE, AIR DEFENSE, M41 (REDEYE) / FIM-43**

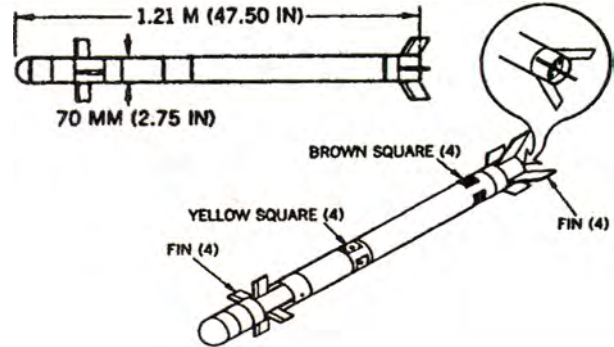

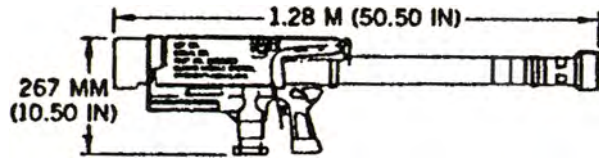

**U.S. GUIDED MISSILE, AIR DEFENSE, M41 (REDEYE) / FIM-43 (LAUNCHER)**

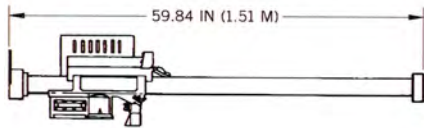

**U.S. GUIDED MISSILES, SURFACE-TO-AIR, FIM-92A, FIM-92B, FIM-92C, FIM-92D, AND FIM-92E (STINGER) (LAUNCHER)**

Ordnance used with:  
T61, ELEC. DET.

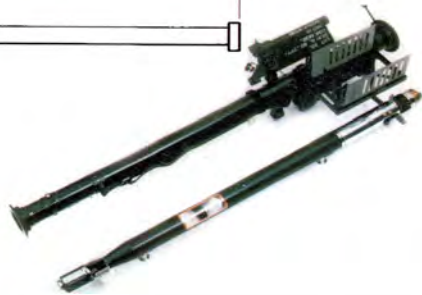

N.E.W. 11.30 LB

## U.S.S.R. GUIDED MISSILE, SURFACE-TO-AIR, SA-14



## U.S.S.R. GUIDED MISSILES, SA-7A, SA-7B, AND SA-N-5 (GRAIL)

Ordnance used with:  
9K32M SYSTEM, USES SA-7B MISSILE  
ZUR-23-2S, GUN/MISSILE AIR DEFENSE SYSTEM,



MARKINGS

**U.S.S.R. GUIDED MISSILE, SURFACE-TO-AIR, SA-16  
AND PRACTICE (GIMLET)**



Ordnance used with:  
9K310E SYSTEM, SA-16 MISSILE



---

**U.S.S.R. GUIDED MISSILE, SURFACE-TO-AIR, SA-18  
(GARGOYLE)**



Ordnance used with:  
MDL. UNKNOWN, GUIDED MISSILE EJECTION MOTOR  
9P39, GUIDED MISSILE SYS. (SA-18)



## U.K. GUIDED MISSILES, SURFACE-TO-AIR, BLOWPIPE

Ordnance used with:  
EJECT MOTOR, MDL. UNKNOWN, BLOWPIPE, K102A1 MK 2  
CTRL. SECTION, MDL. UNKNOWN, BLOWPIPE, K102A1...  
LAUNCH TUBE, MDL. UNKNOWN, BLOWPIPE, K102A1 MK 2

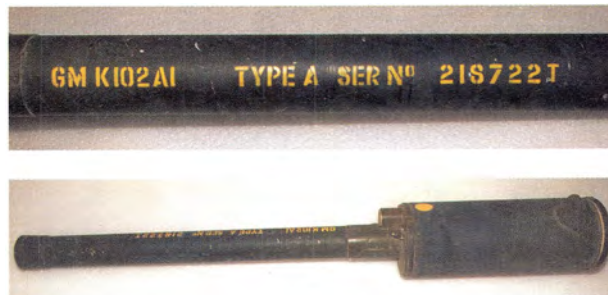

## FRENCH GUIDED MISSILE, SURFACE-TO-SURFACE, MILAN

Ordnance used with:  
UNDESIGNATED, PIBD-ELECTRIC (MILAN, MILAN 2)

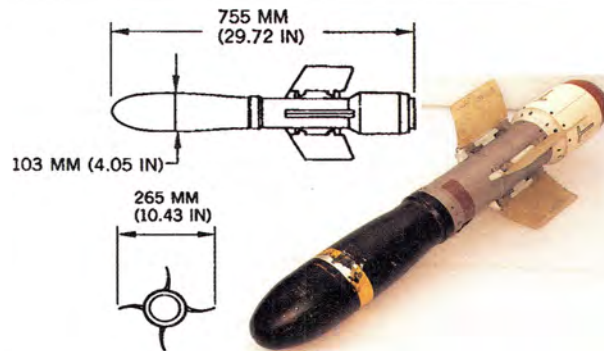

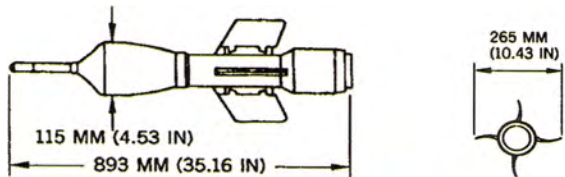

## FRENCH GUIDED MISSILE, SURFACE-TO-SURFACE, MILAN 2

Ordnance used with:  
UNDESIGNATED, PIBD-ELECTRIC (MILAN, MILAN 2)  
WARHEAD, MDL. UNKNOWN, MILAN 2  
RKT MOTOR, MDL. UNKNOWN, MILAN 2  
GUIDANCE & CONTROL, MDL. UNKNOWN, MILAN 2  
LAUNCH TUBE, MDL. UNKNOWN, MILAN 2



## U.S.S.R. GUIDED MISSILE, AT-4A (SPIGOT A)

Ordnance used with:  
LAUNCHER, AT-4 SPIGOT



**U.S.S.R. GUIDED MISSILE, AA-8A**



**U.S.S.R. GUIDED MISSILE, AA-8B**



## **U.S.S.R. GUIDED MISSILE, SURFACE-TO-AIR, SA-13B (GOPHER)**



Ordnance used with:  
MDL. UNKNOWN, MOTOR, SOLID PROPELLANT (SA-13B)  
UNKNOWN, LASER PROX. (SA-13B)  
UNKNOWN, WARHEAD, HE, DISCRETE-RODS (SA-13B)  
UNKNOWN, IMPACT (SA-13B)  
UNKNOWN, SEEKER, EO/IR (SA-13B)

---

## **U.S.S.R. GUIDED MISSILE, SURFACE-TO-SURFACE, AT-3A (SAGGER)**



Ordnance used with:  
WHD. AT-3A & AT-3C MALYUTKA, SAGGER  
RKT MOTOR, AT-3A & AT-3C, MALYUTKA, SAGGER  
GUIDANCE & CTRL, AT-3A & AT-3C MALYUTKA, SAGGER

## U.S.S.R. GUIDED MISSILE, SURFACE-TO-SURFACE, AT-3C (SAGGER)

Ordnance used with:

WHD. AT-3A & AT-3C MALYUTKA, SAGGER

RKT MOTOR, AT-3A & AT-3C, MALYUTKA, SAGGER

GUIDANCE & CTRL, AT-3A & AT-3C MALYUTKA, SAGGER



## U.S.S.R. GUIDED MISSILE, SURFACE-TO-SURFACE, AT-5 (SPANDREL)

Ordnance used with:

GUIDANCE SECTION AT-5A SPANDREL KONKURS

WHD. AT-5A, SPANDREL, 9M113, KONKURS

RKT MOTOR AT-5A, SPANDREL, 9M113, KONKURS





## U.S.S.R. GUIDED MISSILES, SURFACE-TO-AIR, SA-9A AND SA-9B (GASKIN)

Ordnance used with:  
SA-9, GASKIN, SPECIFIC MDL. UNK.



## U.S.S.R. GUIDED MISSILE, AIR-TO-SURFACE, AT-6 (SPIRAL)

Ordnance used with:  
U.S.S.R. RKT MOTOR, MDL. UNK. (AT-6A/SPIRAL)  
U.S.S.R. EJECT MOTOR, MDL. UNK. (AT-6A/SPIRAL)  
U.S.S.R. LAUNCH TUBE, MDL. UNK. (AT-6A/SPIRAL)



**U.S.S.R. GUIDED MISSILE, WIRE, AT (SNAPPER)**

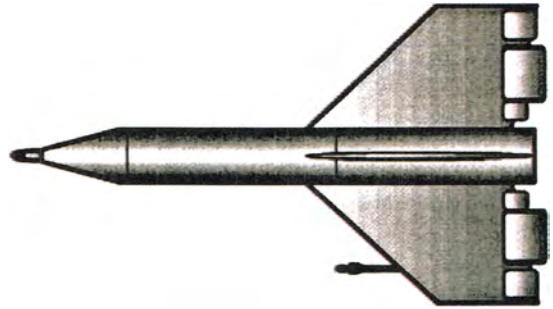

**U.S.S.R. GUIDED MISSILE, SURFACE-TO-SURFACE, AT-2C (SWATTER)**



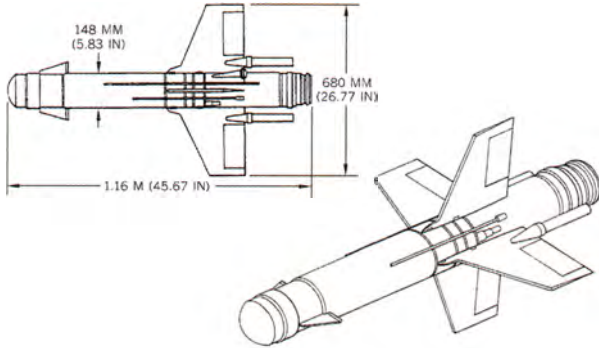

**U.S.S.R. GUIDED MISSILE, SURFACE-TO-SURFACE  
AND AIR-TO-SURFACE, AT-2A SWATTER A**

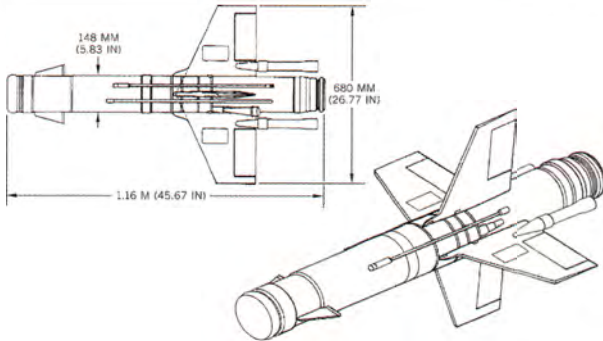

**U.S.S.R. GUIDED MISSILE, SURFACE-TO-SURFACE  
AND AIR-TO-SURFACE, AT-2B SWATTER B**

## U.S. GUIDED MISSILE, AIR-TO-SURFACE, AGM-114K (HELLFIRE II)

Ordnance used with:

AH-64A, HELICOPTER, (APACHE)

AH-1W, AIRCRAFT, HELICOPTER (COBRA)

UH-3A, AIRCRAFT, HELICOPTER (SEA KING)

UH-60 SERIES, AIRCRAFT, HELICOPTERS (BLACK HAWK)

M120E2, RKT MOTOR, (THIOKOL)

M120E4, RKT MOTOR, (HERCULES)

GUIDANCE SECTION, AGM-114 (DESIGNATION UNKNOWN)

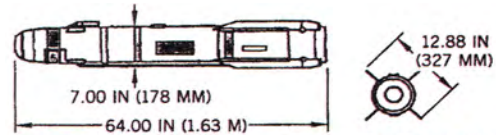

## U.S. GUIDED MISSILES, AIR-TO-SURFACE, AGM-65E & TRAINER, A/A37A-T9 (MAVERICK)

Ordnance used with:

LAU-88/A, LAUNCHER, MISSILE (MAVERICK)

LAU-88A/A, LAUNCHER, MISSILE (MAVERICK)

LAU-117/A, MISSILE LAUNCHER, AIRCRAFT

WDU-24/B, WARHEAD, PENETRATOR, AGM-65G

FMU-135/B, ELECTROMECHANICAL, GUIDED MISSILE,...

RKT MOTOR, AGM-65E

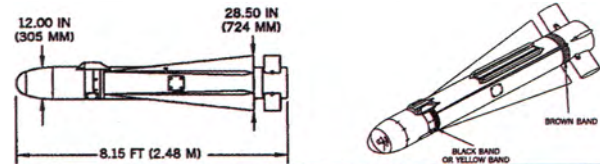

N.E.W. 148.80 LB

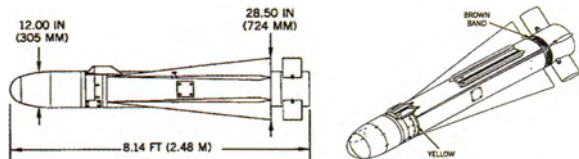

## U.S. GUIDED MISSILES, AIR-TO-SURFACE, AGM-65F & TRAINER, TGM-65F (MAVERICK)

Ordnance used with:

LAU-88/A, LAUNCHER, MISSILE (MAVERICK)  
 LAU-88A/A, LAUNCHER, MISSILE (MAVERICK)  
 LAU-117/A, MISSILE LAUNCHER, AIRCRAFT  
 WDU-24/B, WARHEAD, PENETRATOR, AGM-65G  
 FMU-135/B, ELECTROMECHANICAL, GUIDED MISSILE,...  
 RKT MOTOR, AGM-65F

N.E.W. 148.60 LB

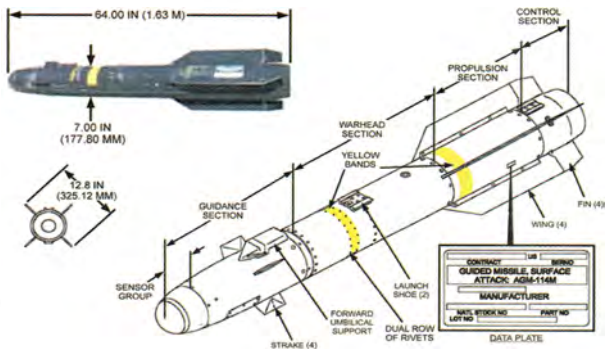

## U.S. GUIDED MISSILE, AIR-TO-SURFACE, AGM-114M

Ordnance used with:

AH-64A, HELICOPTER, (APACHE)  
 M120E1, RKT MOTOR, (THIOKOL), HELLFIRE  
 M120E3, RKT MOTOR, (HERCULES)  
 M120E4, RKT MOTOR, (HERCULES)  
 GUIDANCE SECTION, AGM-114 (DESIGNATION UNKNOWN)  
 UNDESIGNATED, WHD. SECTION, BLAST FRAG (F/ AG...  
 ESAF MODULE, AGM-114 (DESIGNATION UNKNOWN)

## U.S. GUIDED MISSILE (GUIDED DISPENSER), AIR-TO-SURFACE, AGM-154A (JSOW)

Ordnance used with:

BLU-97B/B, HEAT

FSU-24/B, ELECT. SAFE & ARM DEVICE (SAD)

EUROFIGHTER, TYPHOON

DISP. PAYLOAD, AGM-154A, (UNKNOWN DESIGNATION)

N.E.W. 92.60 LB

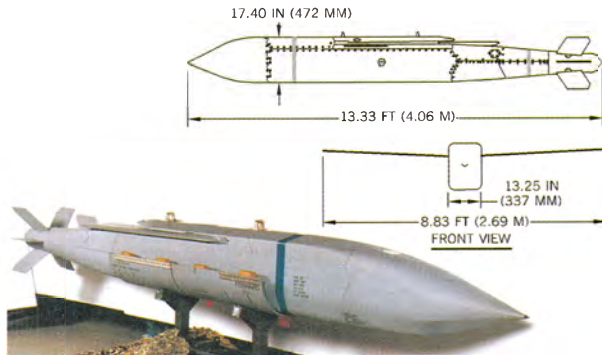

## U.S. GUIDED MISSILES, AIR-TO-SURFACE, AGM-84H & TRAINER ATM-84H (SLAM-ER)

Ordnance used with:

FZU-47/B, AIR PRESS. PROBE, GUIDED MISSILE

FMU-155/B, FUZE

FZU-56/B, AIR PRESS. PROBE

BBU-60/B, BOOSTER

WAU-30C (V2) / B, WHD. SECTION

WDU-40 / B, WHD.

J402, SUSTAINER MOTOR, TURBOFAN

N.E.W. 350.00 LB

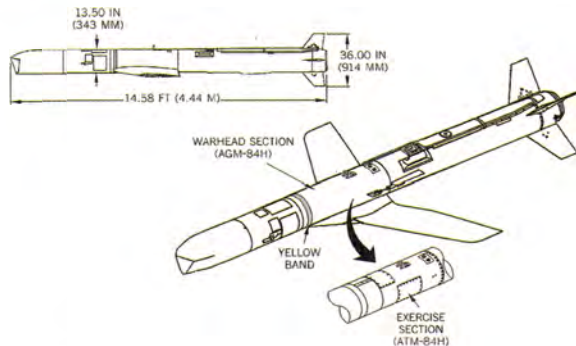

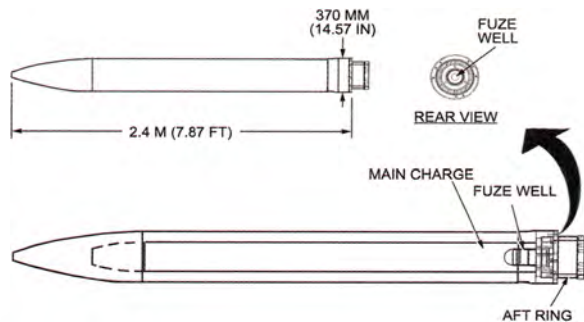

## U.S. GUIDED MISSILE WARHEAD, 1,200-LB, HE-PENETRATION, AUP-3 (M)

Ordnance used with:  
 AGM-86D, CALCM  
 FMU-159/B, BOMB, TAIL, HTSF  
 UNDESIGNATED, CENTER SECTION, F/AGM-86D

N.E.W. 43.09 KG

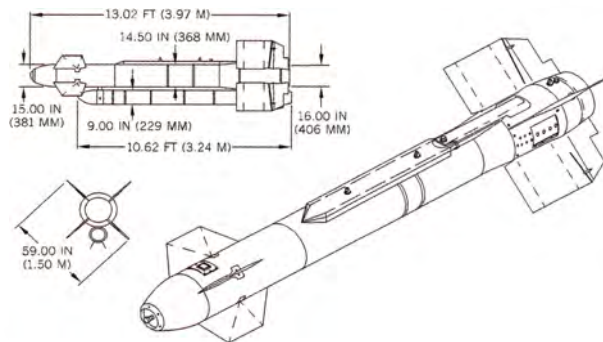

## U.S. GUIDED MISSILE, AIR-TO-SURFACE, AGM-130C

Ordnance used with:  
 BLU-109/B, PENETRATOR  
 FMU-143B/B, NOSE & TAIL, IMPACT  
 FMU-152/B, BOMB FUZE, TAIL  
 JPF  
 DSU-27B/B, GUIDANCE CTRL. UNIT, GUIDED MISSILE  
 WGU-33/B, GUIDANCE CTRL. UNIT, GUIDED MISSILE  
 WGU-40/B, GUIDANCE CTRL. UNIT, GUIDED MISSILE

## U.S.S.R. GUIDED MISSILE, AIR-TO-SURFACE, AS-9 (KYLE)



## U.S. GUIDED MISSILE, AIR-TO-SURFACE, AGM-130A

Ordnance used with:

FMU-124A/B, NOSE & TAIL, IMPACT

FMU-152/B, BOMB FUZE, TAIL

JPF

MK 84, 2000-LB, GP

DSU-27B/B, GUIDANCE CTRL. UNIT, GUIDED MISSILE

WGU-33/B, GUIDANCE CTRL. UNIT, GUIDED MISSILE

WGU-40/B, GUIDANCE CTRL. UNIT, GUIDED MISSILE

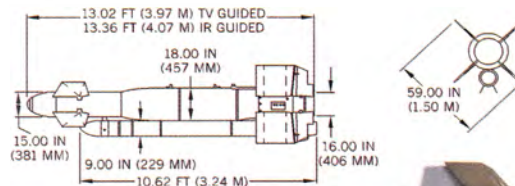

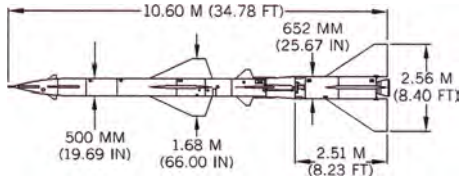

**U.S.S.R. GUIDED MISSILE, SURFACE-TO-AIR, SA-2B,  
SA-2C, SA-2F (GUIDELINE)**



N.E.W. 791.00 KG

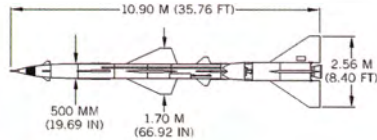

**U.S.S.R. GUIDED MISSILE, SURFACE-TO-AIR, SA-2D  
(GUIDELINE)**



N.E.W. 851.00 KG

**U.S. GUIDED MISSILES, SUBMARINE-TO-SURFACE,  
UGM-109C-1, -2 AND UGM-109D-1, -11, -2; -21  
(TOMAHAWK) (BLAST EFFECTS WARHEAD)**

Ordnance used with:  
RGM-109 WAREADS, CONVENTIONAL, (TOMAHAWK)  
MK 14 MOD 0, MISSILE CAN. SYS. (USED IN THE M...  
MK 1 MOD 0, CAPSULE SYSTEM, TTL  
WDU-25/B, WARHEAD, HE, MISSILE, (TOMAHAWK)  
WDU-36/B, WARHEAD, PENETRATOR, (FOR TOMAHAWK)  
MK 14 MOD 1, MISSILE CANISTERING SYS.

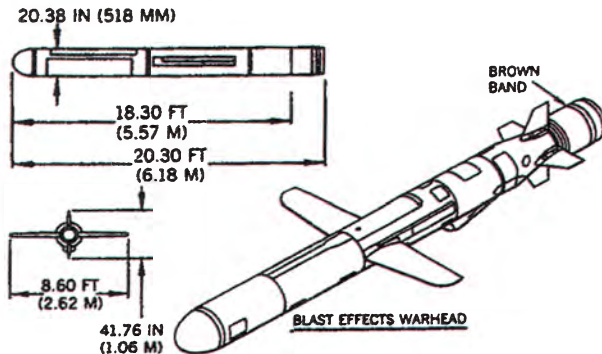

**U.S.S.R. GUIDED MISSILE, SURFACE-TO-AIR, SA-2E  
(GUIDELINE)**

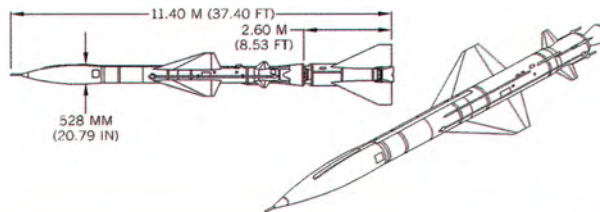



**U.S.S.R. GUIDED MISSILE, SURFACE-TO-AIR,  
SA-3/SA-N-1 (GOA) SERIES**

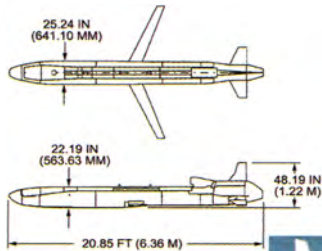

**U.S. GUIDED MISSILE, AIR-TO-SURFACE, AGM-86D  
(CALCM)**

Ordnance used with:  
A/A48K-1(V)2 COMMON STRATEGIC ROTARY LNCHR. (...  
FMU-159A/B, BOMB, TAIL, HTSF  
FMU-159/B, BOMB, TAIL, HTSF  
AUP-3 (M), WARHEAD, 1,200 LB, HE-PENETRATION  
MAU-191/A, ARMING DEVICE  
UNDESIGNATED, FORWARD SECTION, F/ AGM-86D  
SWU-58/A, ROTARY SWITCH  
N.E.W. 47.50 KG



## U.S. GUIDED MISSILE, AIR-TO-SURFACE, CALCM, AGM-86C

Ordnance used with:

FMU-139A/B, NOSE & TAIL, IMPACT

A/A48K-1(V)2 COMMON STRATEGIC ROTARY LNCHR. (...)

MAU-191/A, ARMING DEVICE

SWU-58/A, ROTARY SWITCH

UNDESIGNATED, AFT SECTION, AGM-86 SERIES

F107-WR-101, CALCM ENGINE

FMU-137/A, IMPACT, GUIDED MISSILE (AGM-86C)

N.E.W. 797.00 LB

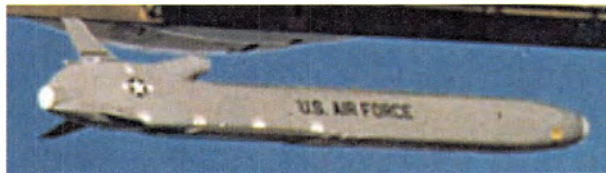
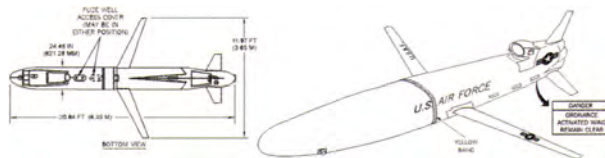

***THIS PAGE INTENTIONALLY LEFT BLANK***

## CANADIAN LANDMINE SYSTEM, 84MM, OFF ROUTE, C14

Ordnance used with:  
FFV 65 CARTRIDGE, 84-MM, HEAT-T



## CHINESE LANDMINE, APERS (BOUNDING), TYPE 69

Ordnance used with:  
MDL. UNKNOWN, LANDMINE, PULL/PRESSURE

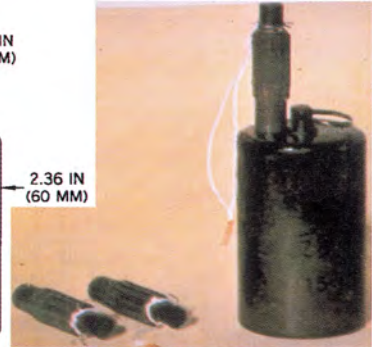
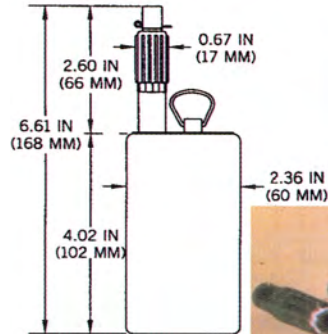

N.E.W. 110.00 G



**CHINESE LANDMINE, APERS, CLAYMORE, TYPE 66**



**PAKISTAN, P5 MK 1, APERS, CLAYMORE**



## PAKISTANI LANDMINE, APERS, P4 MK2



## U.S. LANDMINES: AT, HE, NONMETALLIC, M19; INERT, M19; AND TRAINING, M80

Ordnance used with:  
M/88, MAGNETIC INFLUENCE, LANDMINE  
M606, LANDMINE PRESSURE, AT  
UNDESIGNATED, BOOSTER (52 G RDX)  
UNDESIGNATED, BOOSTER (52 G COMP A-5)

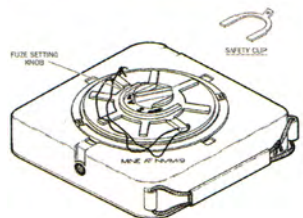
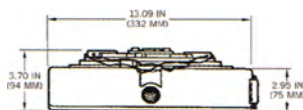

N.E.W. 21.25 LB

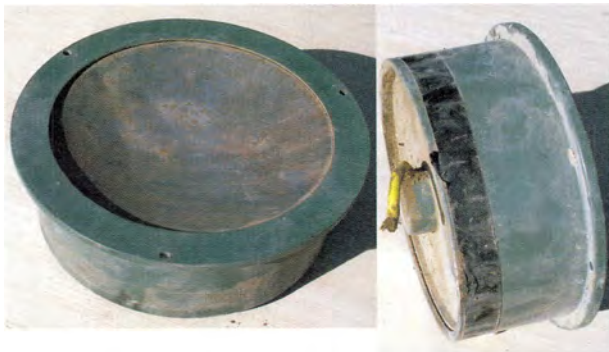

**UNKNOWN COUNTRY, LANDMINE, AT, MODEL UNKNOWN**

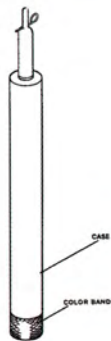
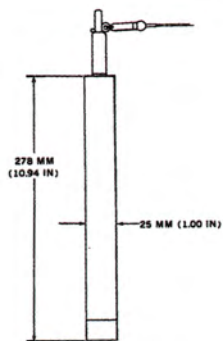

**U.S.S.R. LANDMINE, SIGNAL, SM**

Ordnance used with:  
MUV, PULL  
MUV-2, FIRING DEVICE, PULL/PRESSURE  
MUV-3, FIRING DEVICE, PULL/PRESURE

## YUGOSLAV LANDMINE, APERS, TM100

Ordnance used with:  
UANU-1, LANDMINE, AT, PRESS.  
MDL. UNKNOWN, LANDMINE, PRESS.



## CANADIAN LANDMINE, APERS, CLAYMORE, C19

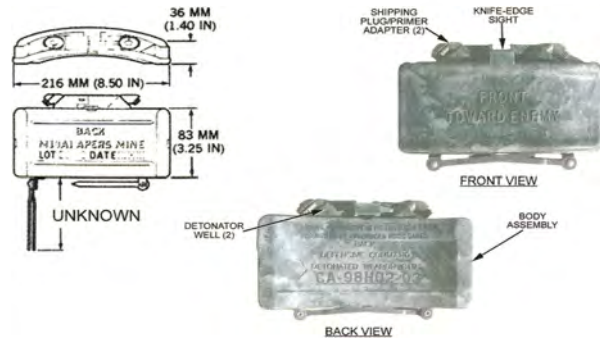

N.E.W. 680.00 G

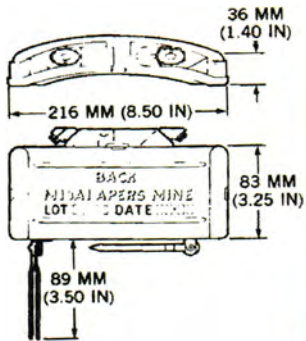

**U.S. LANDMINE, APERS, HE, M18A1; & PRACTICE, M68**

N.E.W. 680.00 G

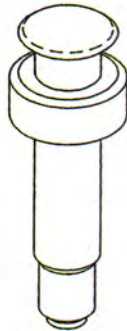
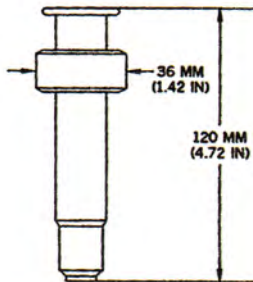

**U.S.S.R. LANDMINE, APERS, PMP**

## ZIMBABWE LANDMINES, APERS, ZAP-1 AND ZAP-2

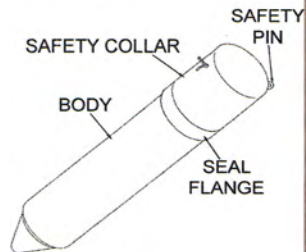

N.E.W. 140.00 G

## EGYPTIAN LANDMINE, APERS, (HAMDY)



N.E.W. 501.60 G

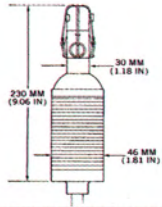

**BELGIAN LANDMINE, APERS, MODEL NR 413**



N.E.W. 95.00 G

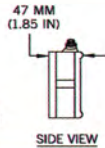
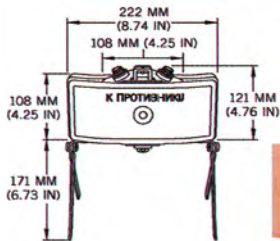

**U.S.S.R. LANDMINE, APERS, FRAG, MON-50**



Ordnance used with:

MUV-4, PULL

NVU-P, LANDMINE CTRL. DEVICE

VP-12, LANDMINE CTRL. DEVICE

NVU-PM, LANDMINE CTRL. DEVICE

VP-13, LANDMINE CTRL. DEVICE

**U.S. LANDMINES, APERS, HE, M14 & M14E1; &  
LANDMINE, APERS, PRACTICE, M17**

Ordnance used with:  
T1204, AP

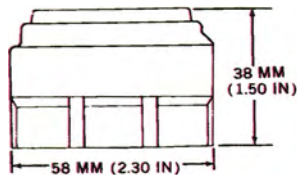

N.E.W. 29.00 G

**CHINESE LANDMINE, APERS, STAKE, TYPE 58**

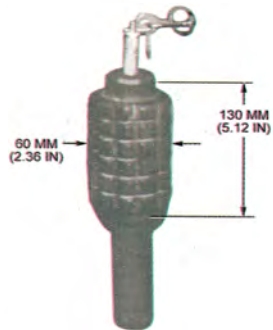

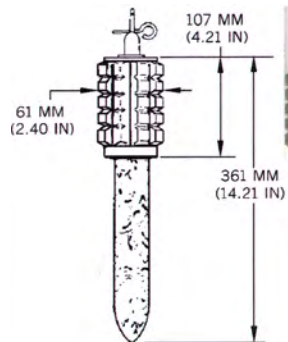

## U.S.S.R. LANDMINE, APERS, POMZ-2M

Ordnance used with:

MUV-4, PULL

MDL. UNKNOWN, PULL

MUV, PULL

MUV-2, FIRING DEVICE, PULL/PRESSURE

MUV-3, FIRING DEVICE, PULL/PRESURE

MV-5, FUZE, LANDMINE, AT, PRESS.

NM, INITIATOR, ELEC.

N.E.W. 75.00 G

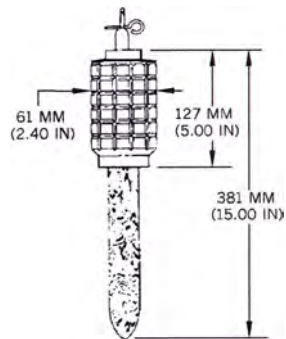

## U.S.S.R. LANDMINES, APERS, POMZ-2 AND PRACTICE, UIPOMZ-2

Ordnance used with:

MUV-4, PULL

MDL. UNKNOWN, PULL

MUV, PULL

MUV-2, FIRING DEVICE, PULL/PRESSURE

MUV-3, FIRING DEVICE, PULL/PRESURE

MV-5, FUZE, LANDMINE, AT, PRESS.

NM, INITIATOR, ELEC.

N.E.W. 75.00 G

## IRANIAN LANDMINE, APERS, NO. 4 (PEDAL)

Ordnance used with:  
MDL. UNKNOWN, LANDMINE, PRESS. (FOR NO. 4 PEDAL)



## YUGOSLAV LANDMINES, APERS, PMA-2; AND PRACTICE, VPMA-2

Ordnance used with:  
UPMAH-2, LANDMINE, APERS, PRESS.

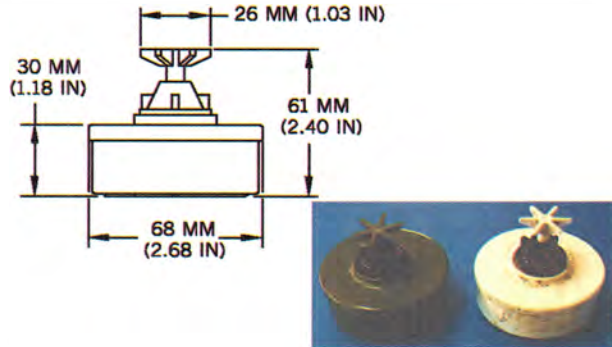

N.E.W. 100.00 G

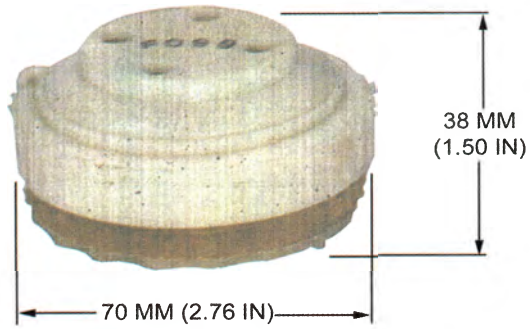

**PAKISTANI LANDMINE, APERS, P2 MK2**

Ordnance used with:  
 P2 MK2, AT, NONMETALLIC  
 P3 MK 2, AT

N.E.W. 58.00 G

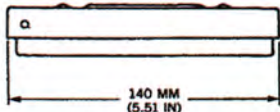

**SIDE VIEW**

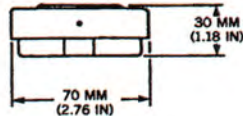

**FRONT VIEW**



**YUGOSLAV LANDMINES, APERS, PMA-1, PMA-1A, & PRACTICE, VPMA-1A**

Ordnance used with:  
 UPM-1, FIRING DEVICE, PULL/PRESSURE/TENSION R...  
 UPMAH-1, LANDMINE, APERS, PRESS.

N.E.W. 200.00 G

## PAKISTANI LANDMINE, AP, JUMPING, MODEL P7 MK1

Ordnance used with:  
P-1 MK 1, HAND, FRAG  
P1 MK 1, HAND, FRAG

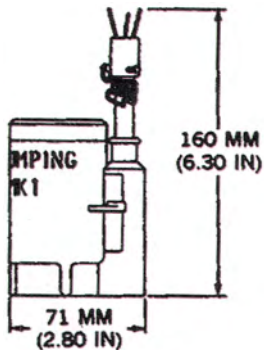

## YUGOSLAV LANDMINES, APERS, BOUNDING, (FRAG), PROM-1 AND PRACTICE VPROM-1

Ordnance used with:  
UPROM-1, LANDMINE, APERS, PRESSURE/PULL  
M61-1, LANDMINE, APERS, PULL



N.E.W. 448.00 G

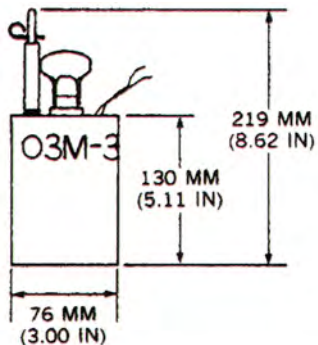

U.S.S.R. LANDMINE, APERS, OZM-3



N.E.W. 75.00 G

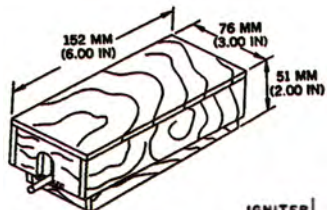

U.S.S.R. LANDMINES, APERS, PMD-7 & PMD-7TS

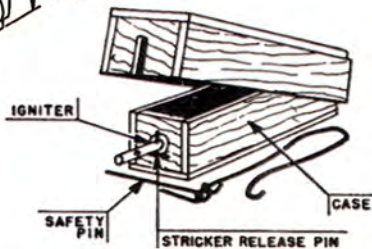

N.E.W. 200.00 G

**CHINESE LANDMINES, APERS, TYPES 72, 72B, AND 72C**

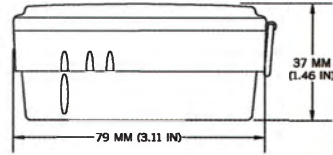

N.E.W. 51.00 G

**BELGIAN LANDMINE, APERS, PRB-M409**

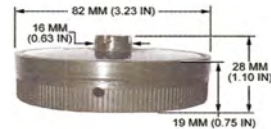
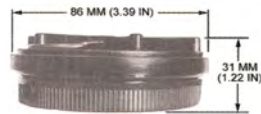

N.E.W. 0.18 LB

## U.K. LANDMINE, APERS, BOUNDING, MK II (MK 2)

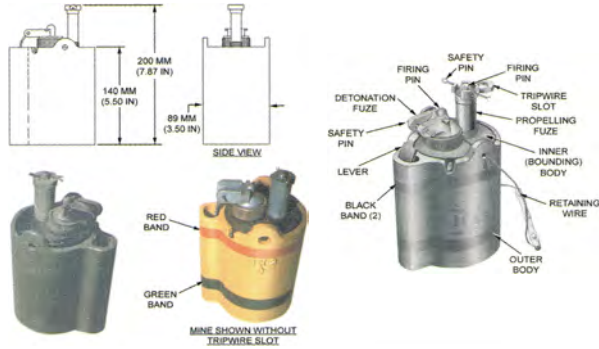

N.E.W. 500.00 G

## U.S. LANDMINES, APERS, HE, M3, M3A1, & M3B1; LANDMINE, INERT, M3

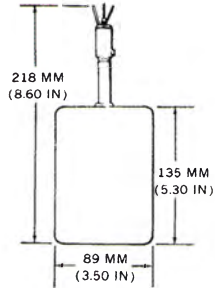

Ordnance used with:  
M3, LANDMINE, APERS, PULL/PRESSURE  
M7, LANDMINE, PULL/PRESSURE

N.E.W. 1.00 LB

## U.S.S.R. LANDMINES, APERS, PMD-6 AND PMD-6M

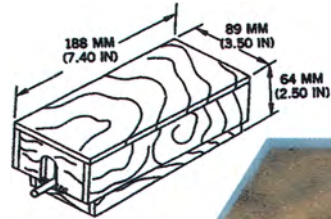

N.E.W. 200.00 G

## U.S.S.R. LANDMINE, APERS, BOUNDING, OZM-4

Ordnance used with:

MUV-4, PULL

MUV, PULL

MUV-2, FIRING DEVICE, PULL/PRESSURE

MUV-3, FIRING DEVICE, PULL/PRESURE

VPF, FIRING DEVICE, PULL

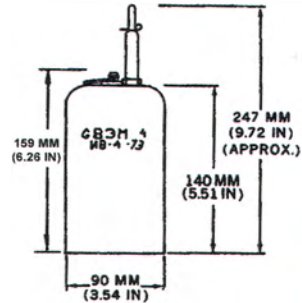

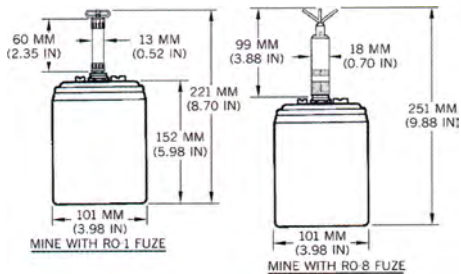

## CZECHOSLOVOKIAN LANDMINES, APERS, PP-MI-SR AND PP-MI-SR II

Ordnance used with:  
 RO-1, LANDMINE, PULL/PRESSURE  
 RO-8, LANDMINE, PRESS.  
 UPM-1, FIRING DEVICE, PULL/PRESS./TENSION RELEASE

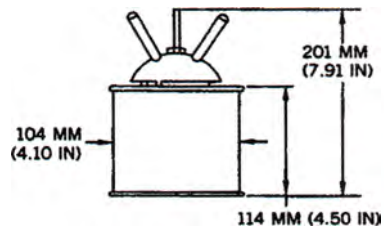

## ITALIAN LANDMINES, APERS, VALMARA AND VALMARA 59

Ordnance used with:  
 UNDESIGNATED, LANDMINE, APERS, PRESSURE/PULL

N.E.W. 564.00 G

## U.S. LANDMINES, APERS, HE, M16 AND M16A1; AND LANDMINES, INERT, M16 AND M16A1

Ordnance used with:

M605, FUZE, LANDMINE, AP, COMBINATION

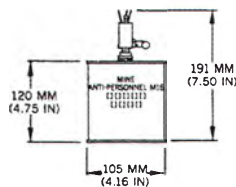

N.E.W. 553.00 G

## U.S.S.R. LANDMINE, APERS, MODEL OZM-72

Ordnance used with:

NVU-P, LANDMINE CTRL. DEVICE

VP-12, LANDMINE CTRL. DEVICE

NVU-PM, LANDMINE CTRL. DEVICE

VP-13, LANDMINE CTRL. DEVICE

MUV, PULL

MUV-2, FIRING DEVICE, PULL/PRESSURE



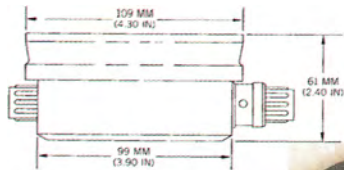

**HUNGARIAN LANDMINE, APERS, GYATA-64**

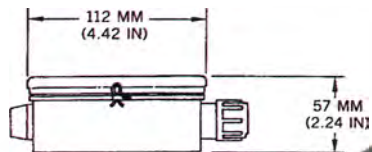

**U.S.S.R. LANDMINE, APERS, PMN**



Ordnance used with:  
SVP, PYROTECHNIC ARMING DEVICE

N.E.W. 227.00 G

## U.S.S.R. LANDMINE, APERS, PMN-2

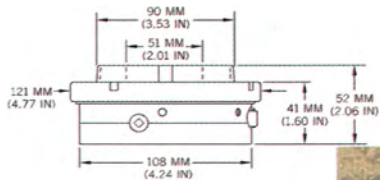

N.E.W. 115.00 G

## U.S.S.R. LANDMINE, AT, YAM-5

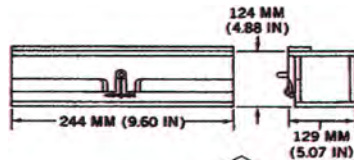

Ordnance used with:  
MUV, PULL

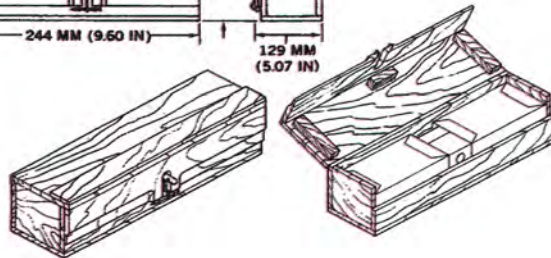

N.E.W. 5.20 KG

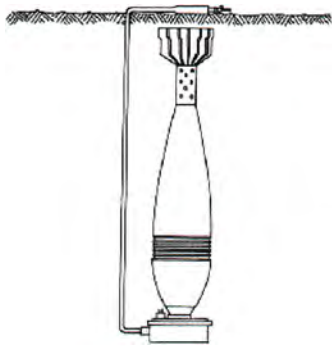

U.S.S.R. LANDMINE, APERS, OZM

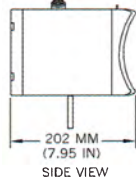
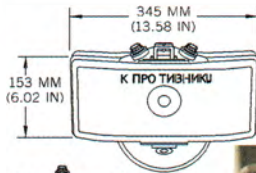

U.S.S.R. LANDMINE, APERS, FRAG, MON-90

Ordnance used with:

MUV-4, PULL

NVU-PM, LANDMINE CTRL. DEVICE

VP-13, LANDMINE CTRL. DEVICE

MUV, PULL

MUV-2, FIRING DEVICE, PULL/PRESSURE

## U.K. LANDMINES, AT, GS MK V, & GS MK V, HC

Ordnance used with:  
NO. 3 MK 1, LANDMINE, AT, PRESS.

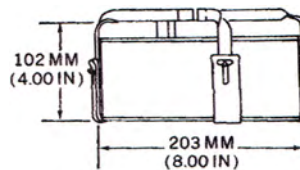

## EGYPTIAN LANDMINE, AT, M/80

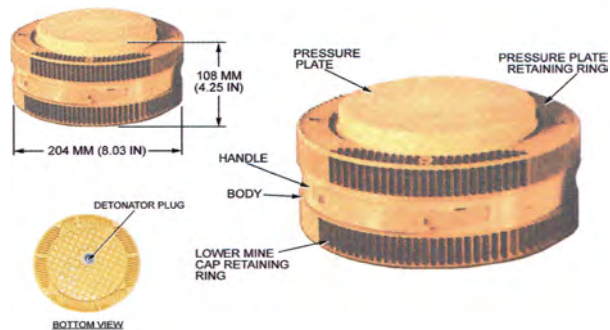

N.E.W. 2.40 KG

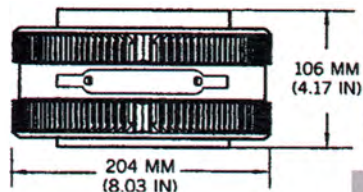

### ITALIAN LANDMINE, AT, TC/2.4

Ordnance used with:  
MDL. UNKNOWN, ANTI LIFT

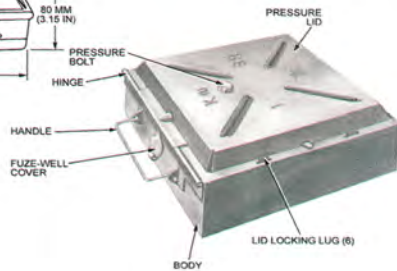
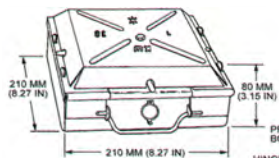

### U.S.S.R. LANDMINE, AT, TM-38

Ordnance used with:  
MUV, PULL  
UV, FIRING DEVICE, PULL

N.E.W. 2.80 KG

## BELGIAN LANDMINE, AT, PRB M3A1

Ordnance used with:  
PRB-M30, ANTLIFT DEVICE  
M60, LANDMINE, PRESS.  
PRB MIG M60, LANDMINE, PRESS.  
PRB 2144, FIRING DEVICE, PULL

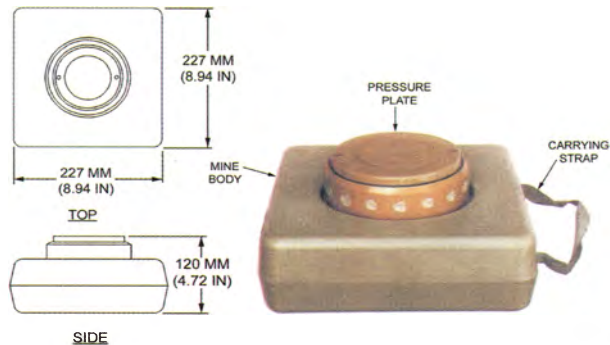

N.E.W. 6.00 KG

## ITALIAN LANDMINE, AT, SB-81; SPANISH C-5; PORTUGUESE M/453; AND IRANIAN YM-II

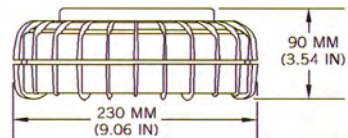

N.E.W. 2.20 KG

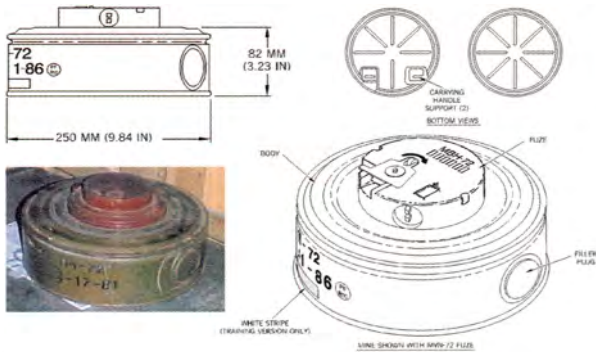

## U.S.S.R. LANDMINE, AT TM-72

N.E.W. 2.50 KG

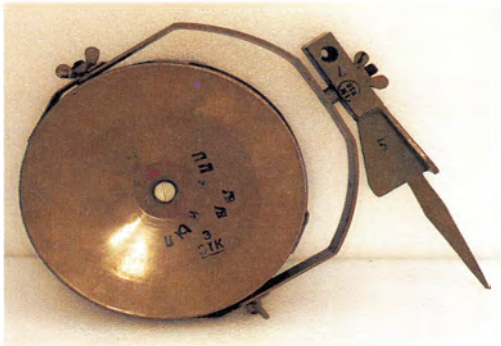

## U.S.S.R. LANDMINE, APERS, MON-100

Ordnance used with:

MUV-4, PULL  
 NVU-P, LANDMINE CTRL. DEVICE  
 VP-12, LANDMINE CTRL. DEVICE  
 NVU-PM, LANDMINE CTRL. DEVICE  
 VP-13, LANDMINE CTRL. DEVICE  
 MUV, PULL

N.E.W. 2.16 KG

## U.S.S.R. LANDMINES, AT, TM-41 & TM-44

Ordnance used with:  
MV-5, FUZE, LANDMINE, AT, PRESS.  
MV-5K, FUZE, LANDMINE, AT, PRESS.

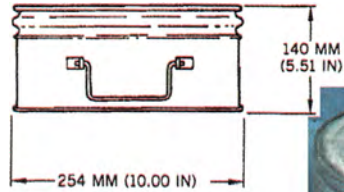

## ITALIAN LANDMINE, AT, SH-55

Ordnance used with:  
VS-N-TLC, ELEC, FIELD PROGRAMMABLE, R/C PRESS...  
VS-N-EL2, ELEC, FIELD PROGRAMMABLE, PRESS./AN...  
VS-N/AR-AN, ELECTRONIC, ANIT-REMOVAL/DISTRUBANCE  
VS-N, PRESSURE-ACTUATED  
FD-64, LANDMINE, AT, PRESS.  
SH-160, LANDMINE, AT, PRESS.

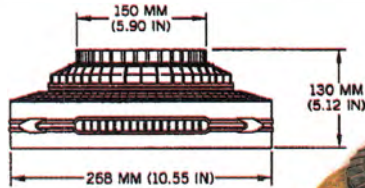

N.E.W. 5528.00 G

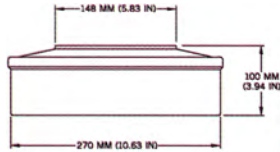

## CHINESE LANDMINE, AT, TYPE 72

Ordnance used with:  
TYPE 69, LANDMINE, AT, DOUBLE IMPULSE  
TYPE 72A, LANDMINE, AT, (SINGLE IMPULSE)  
TYPE 81, LANDMINE, AT (SINGLE IMPULSE)  
TYPE 72, LANDMINE, AT, PRESS. (BLAST RESISTANT)  
TYPE 74, 284MM, CARGO

N.E.W. 6.60 KG

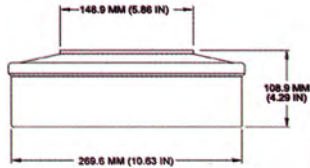

## IRANIAN LANDMINE, AT, YM-III

Ordnance used with:  
UNKNOWN, LANDMINE, AT, PRESS.

N.E.W. 5.69 KG

## ITALIAN LANDMINE, AT, ELECTRONIC, TCE/6

Ordnance used with:  
MDL. UNKNOWN, AT, ELECT. FUZE, (TCE/6)

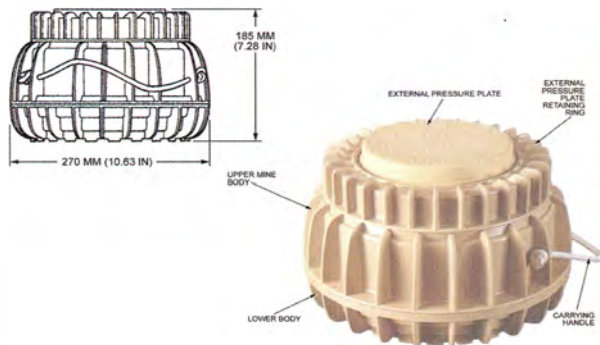

## ITALIAN LANDMINE, AT, TC/3.6

Ordnance used with:  
UNKNOWN, PRESSURE, LANDMINE (TC/3.6)

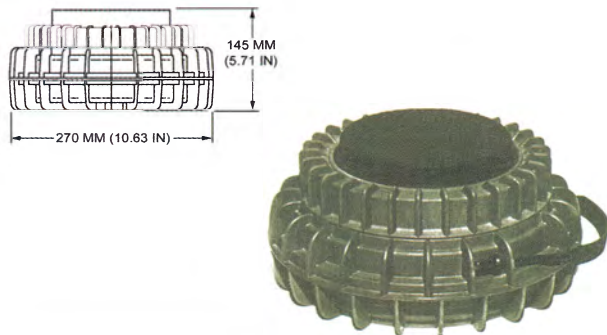

N.E.W. 3.60 KG

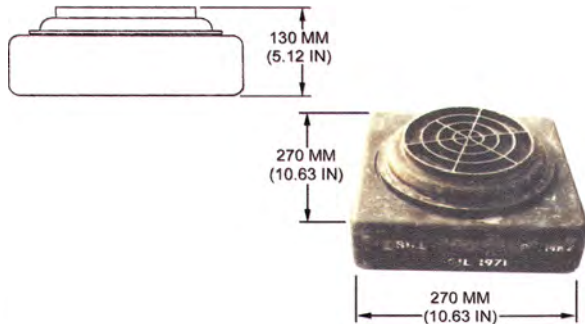

## PAKISTANI LANDMINE, AT, P2 MK 2

Ordnance used with:  
P2 MK 2, APERS

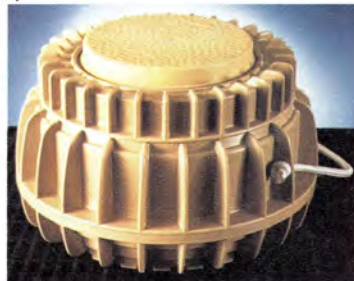
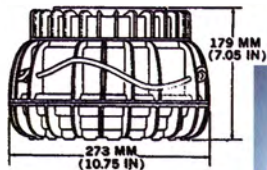

## ITALIAN LANDMINE, AT, MODEL TC-6

Ordnance used with:  
MDL. UNKNOWN, ANTILIFT  
UNKNOWN, FIRING DEVICE, IMPROVISED, PHOTOELECTRIC  
MDL. UNKNOWN, FIRING DEVICE, ANTILIFT

## YUGOSLAV LANDMINES, AT, NONMETALLIC, MODEL TMA-5 & PRACTICE, VTMA-5

Ordnance used with:  
UANU-1, LANDMINE, AT, PRESS.

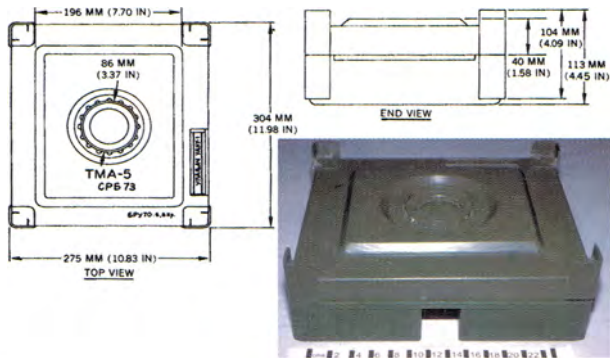

N.E.W. 5561.00 G

## U.S.S.R. LANDMINE, AT/APERS, PMZ-40

Ordnance used with:  
MUV, PULL  
MV-5, FUZE, LANDMINE, AT, PRESS.  
MV-3, FUZE, LANDMINE, AT, PRESS.  
UV, FIRING DEVICE, PULL

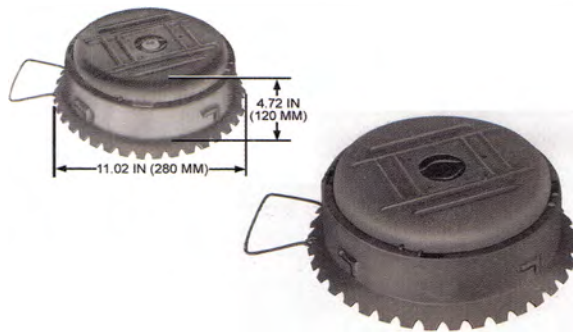

N.E.W. 8.00 LB

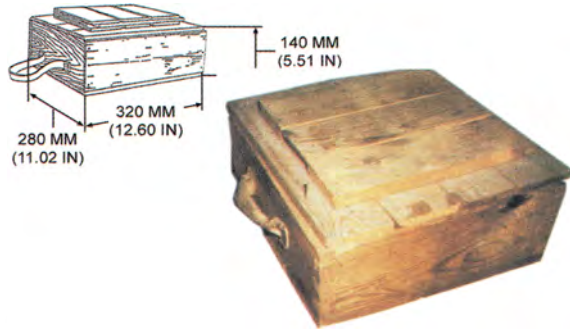

## YUGOSLAV LANDMINE, AT, TMD-1

Ordnance used with:  
 UANU-1, LANDMINE, AT, PRESS.  
 UPM-1, FIRING DEVICE, PULL/PRESSURE/TENSION R...  
 MV-5, MINE, PRESS.

N.E.W. 5.50 KG

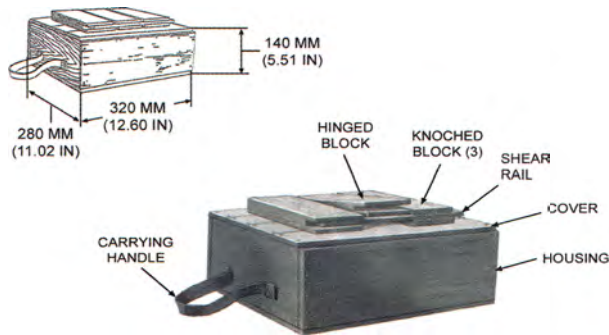

## YUGOSLAV LANDMINE, AT, TMD-2D

Ordnance used with:  
 MV-5, FUZE, LANDMINE, AT, PRESS.  
 UANU-1, LANDMINE, AT, PRESS.

N.E.W. 5.50 KG

## U.S.S.R. LANDMINE, AT, TMD-B

Ordnance used with:

MV-5, FUZE, LANDMINE, AT, PRESS.

MV-5K, FUZE, LANDMINE, AT, PRESS.

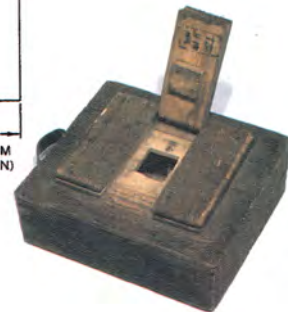
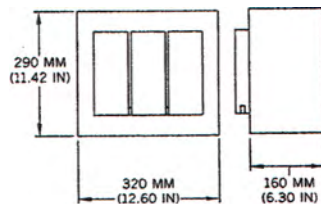

N.E.W. 6.90 KG

## U.S.S.R. LANDMINES, AT, TMD-44, AND PRACTICE, UITMD-44; AND INERT UTMD-44

Ordnance used with:

MV-5, FUZE, LANDMINE, AT, PRESS.

MV-5K, FUZE, LANDMINE, AT, PRESS.

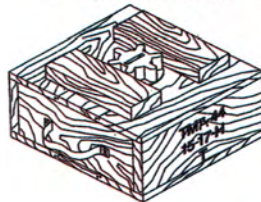
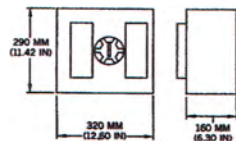

N.E.W. 6.90 KG

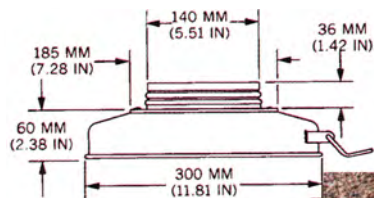

## CZECHOSLOVOKIAN LANDMINE, AT, PT-MI-K

Ordnance used with:  
 RO-3, FIRING DEVICE, PRESSURE-RELEASE  
 RO-5, LANDMINE, AT, PRESS.  
 RO-9, LANDMINE, AT, PRESS.

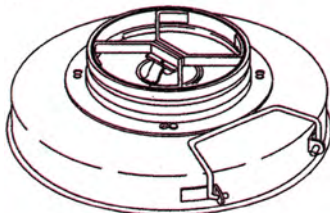
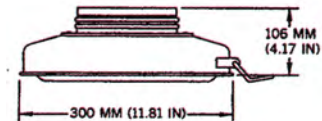

## CZECHOSLOVOKIAN LANDMINE, AT, PT-MI-K II

Ordnance used with:  
 RO-3, FIRING DEVICE, PRESSURE-RELEASE  
 RO-5, LANDMINE, AT, PRESS.

## HUNGARIAN LANDMINE, AT, UKA-63

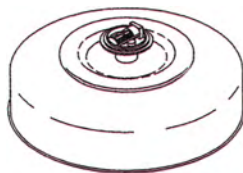

## U.S.S.R. LANDMINE AT, TMK-2

Ordnance used with:  
MVK-2, LANDMINE, AT, TILTROD



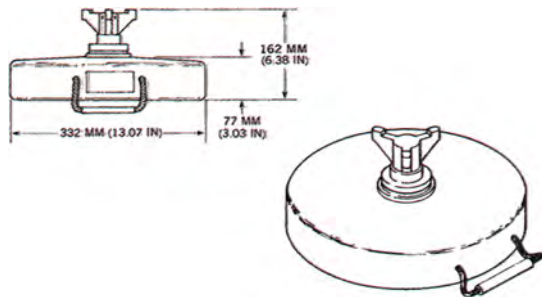

## SWEDISH LANDMINES, AT, MI 102 (OBSOLETE)

Ordnance used with:  
MDL. UNKNOWN, LANDMINE, AT, PRESS.

N.E.W. 7.50 KG

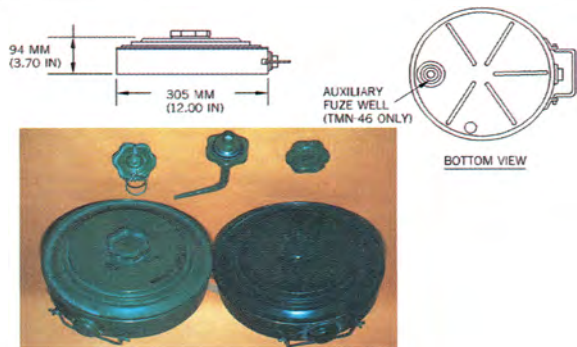

## U.S.S.R. LANDMINES, AT, TM-46 AND TMN-46; AND TRAINING, UITM-46

Ordnance used with:  
MUV, PULL  
MUV-2, FIRING DEVICE, PULL/PRESSURE  
MUV-3, FIRING DEVICE, PULL/PRESURE  
MV-5, FUZE, LANDMINE, AT, PRESS.  
MVM, FUZE, LANDMINE, AT, PRESS.  
MVSH-46, FUZE, LANDMINE, TILTROD

**PAKISTANI LANDMINE, AT, NONMETALLIC, MODEL  
P3 MK 1 (ROUND)**

Ordnance used with:  
P2 MK 2, APERS



**U.S.S.R. LANDMINE, AT, TM-57**

Ordnance used with:  
MVSH 57, LANDMINE, AT, TILTROD  
MVZ-57, LANDMINE, AT, PRESS.

71 MM (2.80 IN)

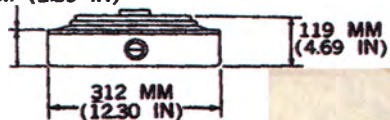

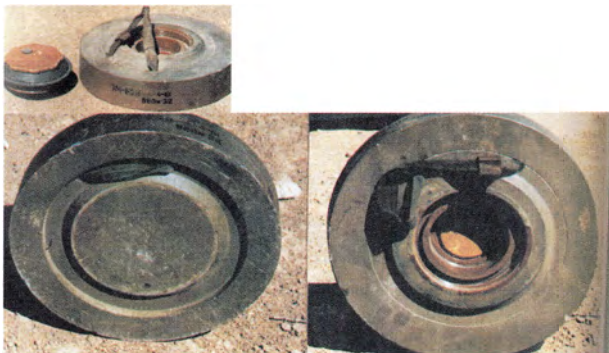

### U.S.S.R. LANDMINE, AT, TM-62B

Ordnance used with:

MVCH-62, FUZE, LANDMINE, AT, PRESS.  
MVN-62, FUZE, LANDMINE, AT, MAGNETIC INFLUENCE  
MVP-62, FUZE, LANDMINE, AT, PRESS.  
VM-62, FUZE, LANDMINE, AT, PRESS.  
MWP-62, FUZE, LANDMINE, AT, PRESS.  
MVCH-62Z, FUZE, LANDMINE, AT, PRESS.  
VM-62Z, FUZE, LANDMINE, AT, PRESS.



### BULGARIAN LANDMINE, AT, TM-62M

Ordnance used with:

MVCH-62, FUZE, LANDMINE, AT, PRESS.  
MVN-62, FUZE, LANDMINE, AT, MAGNETIC INFLUENCE  
MVP-62, FUZE, LANDMINE, AT, PRESS.  
NV-PTM, FUZE, LANDMINE, AT, MAGNETIC INFLUENCE  
NV-PTM-RC, AT, MAGNETIC INFLUENCE, REMOTE CTRL.  
VM-62, FUZE, LANDMINE, AT, PRESS.  
MWP-62, FUZE, LANDMINE, AT, PRESS.

N.E.W. 5700.00 G

## U.S.S.R. LANDMINE, AT, TM-62P2

Ordnance used with:

MVCH-62, FUZE, LANDMINE, AT, PRESS.  
MVN-62, FUZE, LANDMINE, AT, MAGNETIC INFLUENCE  
MVP-62, FUZE, LANDMINE, AT, PRESS.  
VM-62, FUZE, LANDMINE, AT, PRESS.  
MWP-62, FUZE, LANDMINE, AT, PRESS.  
MVCH-62Z, FUZE, LANDMINE, AT, PRESS.  
VM-62Z, FUZE, LANDMINE, AT, PRESS.

N.E.W. 7200.00 G



## U.K. LANDMINE, AT, MK 7

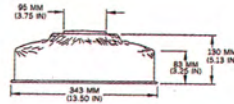

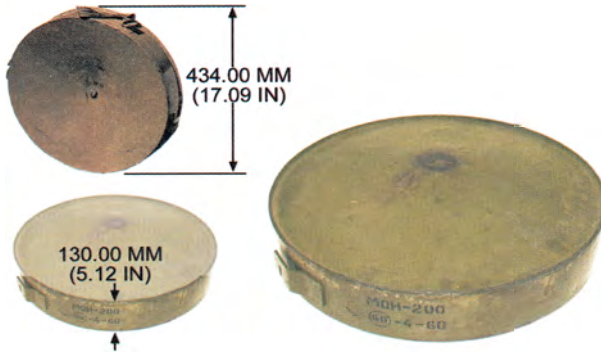

## U.S.S.R. LANDMINE, APERS, MON-200

Ordnance used with:

MUV-4, PULL

NVU-P, LANDMINE CTRL. DEVICE

VP-12, LANDMINE CTRL. DEVICE

NVU-PM, LANDMINE CTRL. DEVICE

VP-13, LANDMINE CTRL. DEVICE

MUV, PULL

N.E.W. 12.16 KG

## U.S.S.R. SMOKE POT, MODEL UNKNOWN



## GERMAN FLARE, AIRCRAFT, COUNTERMEASURES, INFRARED, DM 69

Ordnance used with:  
AN/ALE-40 (V), DISPENSER, COUNTERMEASURES, AI...  
MJU-12/A, MAGAZINE, AIRCRAFT, FLARE  
BBU-36, IMPULSE CARTRIDGE

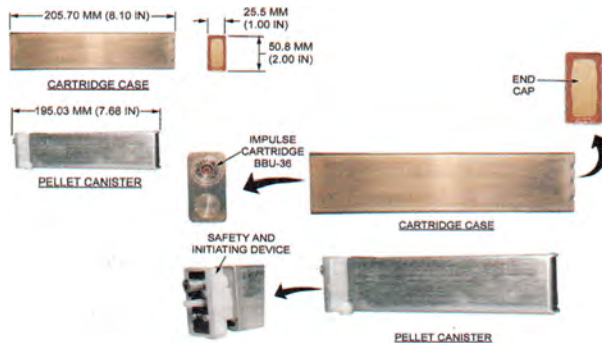

N.E.W. 6.40 OZ

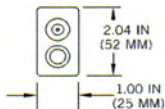
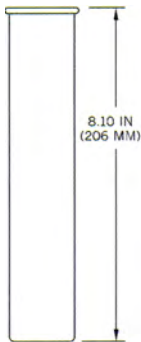

## U.S. CARTRIDGE, FLARE, INFRARED COUNTERMEASURES, MJU-7/B

Ordnance used with:

AN/ALE-40 (V), DISPENSER, CNTRMSRES, AIRCRAFT  
 AN/ALE-45, DISPENSER, COUNTERMEASURE, AIRCRAFT  
 AN/ALE-47, DISPENSER, COUNTERMEASURES, AIRCRAFT  
 MJU-12/A, MAGAZINE, AIRCRAFT, FLARE  
 MDL. UNDESIGNATED, PELLET, FLARE (MECHANICAL)  
 MDL. UNDESIGNATED, PELLET, SMOKE (PARASITIC)  
 AN/ALE-52, DISPENSER, COUNTERMEASURES, AIRCRA...

N.E.W. 1.00 G

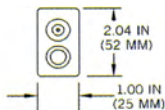
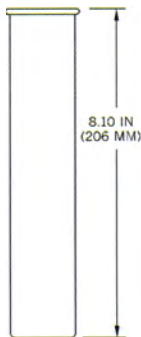

## U.S. CARTRIDGE, FLARE, INFRARED COUNTERMEASURES, MJU-7A/B

Ordnance used with:

AN/ALE-40 (V), DISPENSER, COUNTERMEASURES, AI...  
 AN/ALE-45, DISPENSER, COUNTERMEASURE, AIRCRAFT  
 AN/ALE-47, DISPENSER, COUNTERMEASURES, AIRCRAFT  
 MJU-12/A, MAGAZINE, AIRCRAFT, FLARE  
 MDL. UNDESIGNATED, PELLET, SMOKE (PARASITIC V...  
 AN/ALE-52, DISPENSER, COUNTERMEASURES, AIRCRA...  
 MULTI-PAYLOAD DISP. ASSEMBLY, FLARE/CHAFF(F/A...

N.E.W. 1.00 G

## U.S. CARTRIDGE, FLARE, M206

Ordnance used with:

AN/ALE-40 (V), DISPENSER, CNTRMSRES, AIRCRAFT  
AN/ALE-45, DISPENSER, COUNTERMEASURE, AIRCRAFT  
AN/ALE-47, DISPENSER, COUNTERMEASURES, AIRCRAFT  
M130, DISPENSER, AIRCRAFT, GENERAL PURPOSE  
XM130, DISPENSER, AIRCRAFT, GENERAL PURPOSE  
CH-53A, AIRCRAFT, HELICOPTER, (SEASTALLION)  
CH-53C, AIRCRAFT, HELICOPTER, (SEA STALLION)

N.E.W. 6.00 OZ

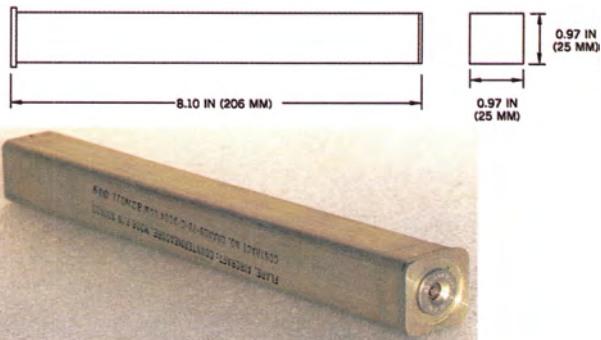

## U.S. CARTRIDGE, FLARE, MJU-50/B

Ordnance used with:

AN/ALE-40 (V), DISPENSER, CNTRMSRES, AIRCRAFT  
AN/ALE-47, DISPENSER, COUNTERMEASURES, AIRCRAFT  
MJU-11/A, MAGAZINE, AIRCRAFT, CHAFF/FLARE

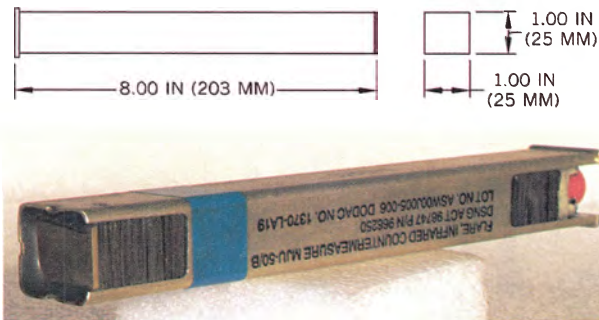

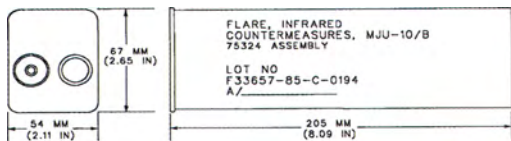

## U.S. CARTRIDGE, FLARE, COUNTERMEASURES, MJU-10/B

Ordnance used with:

AN/ALE-40 (V), DISPENSER, CNTRMSRES, AIRCRAFT  
AN/ALE-45, DISPENSER, COUNTERMEASURE, AIRCRAFT  
C-5A, AIRCRAFT, CARGO (GALAXY)  
C-5B, AIRCRAFT, CARGO (GALAXY)  
F-15E, AIRCRAFT, FIGHTER (EAGLE)  
MJU-17/A, MAGAZINE, AIRCRAFT, FLARE  
MJU-41/A, MAGAZINE, FLARE, CNTRMSRES, AIRCRAFT

N.E.W. 2.00 LB

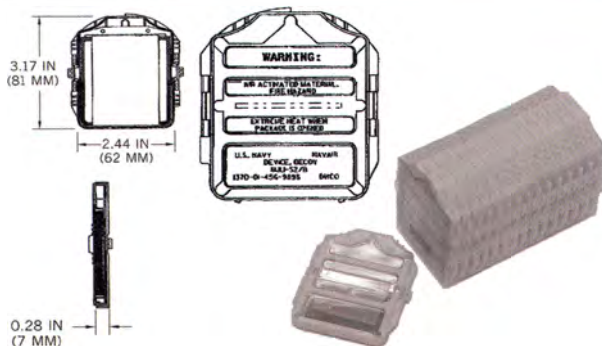

## U.S. FLARE DECOY, INFRARED, MJU-52/B (BOL-IR)

Ordnance used with:

LAU-138A/A, DISPENSER, FLARE/CHAFF, CNTRMSR  
AN/ALE-58, DISPENSER, COUNTERMEASURE, AIRCRAF...  
BOL-515, DISPENSER, COUNTERMEASURES, AIRCRAFT...

N.E.W. 1.50 OZ

## U.S. CARTRIDGE, FLARE, INFRARED COUNTERMEASURES, MJU-23A/B

Ordnance used with:  
AN/ALE-49, DISPENSER, AIRCRAFT, FLARE (B-1B)

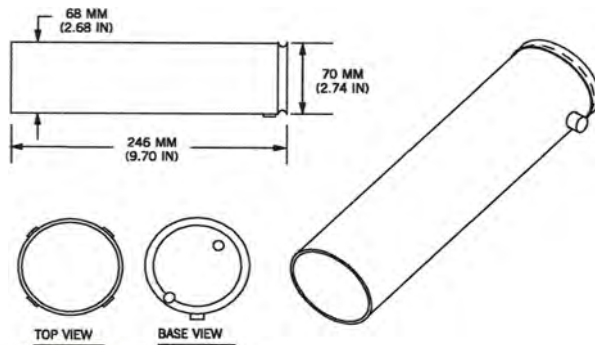

N.E.W. 3.10 LB

## U.S. FLARE SET, AN/ALA-17A

Ordnance used with:  
B-52D, AIRCRAFT, BOMBER, (STRATOFORTRESS)  
ALA-17B, FLARE, CARTRIDGE  
AN/ALE-20, DISPENSER, AIRCRAFT, FLARE  
ALA-17, FLARE, CARTRIDGE  
ALA-17A, FLARE, CARTRIDGE  
RR108/ALA-17, PELLET, FLARE

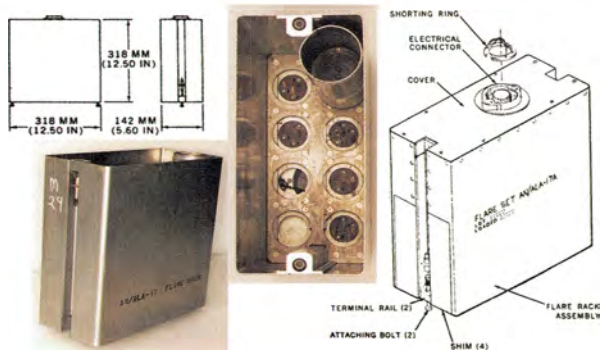

***THIS PAGE INTENTIONALLY LEFT BLANK***

**AFGHAN FIRING DEVICE, ELECTRONIC DELAY,  
MODEL UNKNOWN**



**TERRORIST/INSURGENT & GUERRILLA ORG FIRING  
DEVICE, IMPROVISED, RADIO CONTROLLED (R/C),  
MOVING COIL METER**



DIMENSIONS  
UNKNOWN

DIMENSIONS  
UNKNOWN



RADIO



METER  
NEEDLE

SOLDERED  
CONNECTOR

METER

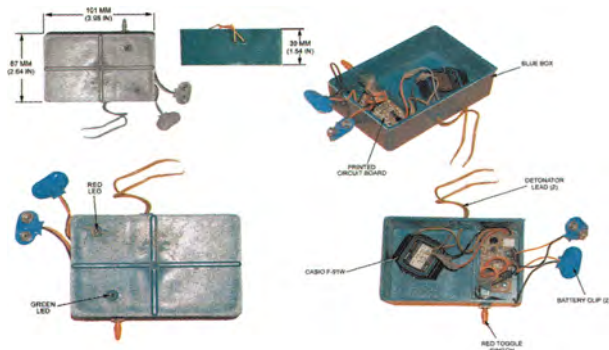

**AFGHAN FIRING DEVICE, ELECTRONIC TIMER, MODEL UNKNOWN**

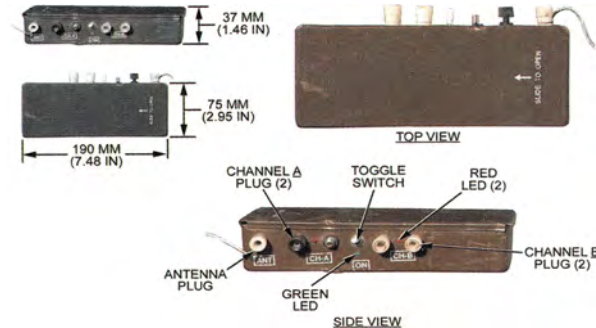

**TERRORIST/INSURGENT & GUERRILLA ORG IMPROVISED DEVICE, RADIO CONTROLLED (R/C), DTMF, BROWN BOX, MODEL UNKNOWN**

Ordnance used with:  
IMPROVISED EXPLOSIVE DEVICES, SUGGESTED EOD P...

**U.S.S.R. ACTUATOR MECHANISM ASSEMBLY,  
EXPLOSIVE, 549S / BR 549C / MN 549C, (USED WITH  
BFK-AO 2.5 CONTAINER ASSEMBLY)**

Ordnance used with:

KMGU

KMGU-2, DISPENSER, CAPTIVE

BKF AO-2.5 RT, SUBMUN. CTR UNIT, BOMB DISPENS...

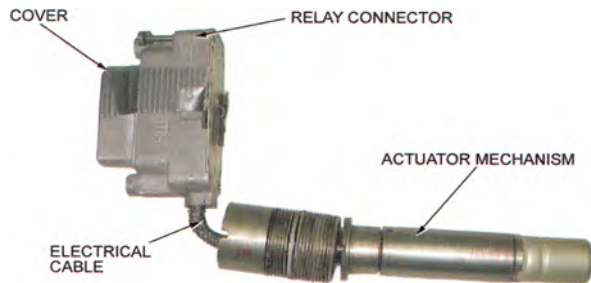

**U.S.S.R. AIRCRAFT FLARE, PK-3M-1**





**U.S.S.R. DEMOLITION CHARGE, SZ-3A**



**MARKINGS**



**U.S.S.R. EXPLOSIVE DISCONNECT/DEPLOYMENT MECHANISM, KP-527**

Ordnance used with:  
ZAB 500 SH, BOMB, INCENDIARY, 500 KG  
RBK-500 BETAB, DISPENSER, BETAB, 500 KG  
RBK-500 PTAB-1M, CBU  
AV-527, NOSE, ELEC.  
RBK-500 AO-2.5 RTM, CLUSTER BOMB  
RBK-500 AO-2.5 RT, CBU  
RBK-500 ZAB 2.50SM, CBU

**U.S.S.R. CARTRIDGE, PHOTOFLASH, FP-100M**



MARKINGS



N.E.W. 533.00 G

**U.S.S.R. ROCKET EXPELLING CHARGE, 57-MM,  
PG-16P**

Ordnance used with:  
PG-16, 58MM, HEAT-T  
PG-16V, 58MM, CARTRIDGE, HEAT

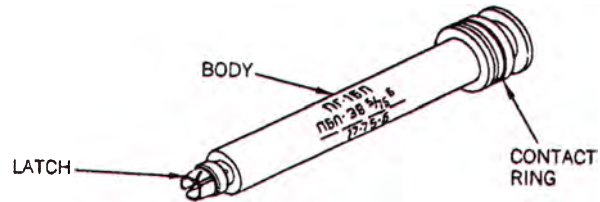

N.E.W. 281.00 G



**AFGHAN RECEIVER, FIRING DEVICE, RADIO CONTROLLED (RC), MODEL UNKNOWN**

Ordnance used with:

MDL. UNKNOWN, KIT, FIRING DEV, RADIO CONTROLL...

MDL. UNKNOWN, TRANSMITTER, RADIO CONTROLLED (RC)



---

**AFGHAN TRANSMITTER, FIRING DEVICE, RADIO CONTROLLED (RC), MODEL UNKNOWN**



Ordnance used with:

MDL. UNKNOWN, KIT, FIRING DEV, RADIO CONTROLL...

MDL. UNKNOWN, RECEIVER, RADIO CONTROLLED (RC)



U.S.S.R. ROCKET MOTOR, NMF-2



***THIS PAGE INTENTIONALLY LEFT BLANK***



***THIS PAGE INTENTIONALLY LEFT BLANK***

## U.S.S.R. BOMB, FRAG, AO-2.5

Ordnance used with:

AGM 1, BOMB, NOSE

AGM 3, BOMB, NOSE

AM B, BOMB, NOSE

AM B B/V, BOMB, NOSE

TM-4A, NOSE, MT

RBK-250, CLUSTER, ADAPTER

RBK-500, DISP. (OLD STYLE)

N.E.W. 0.09 KG



## U.S.S.R. BOMB, HE, AO-1

Ordnance used with:

RBK-250-275, DISP.

RBK-250, DISP.



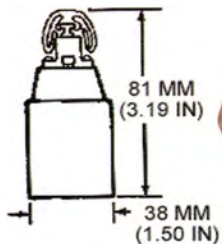

### U.S. GRENADE, DP, M42

Ordnance used with:

M483, 155-MM, HE

M483A1, 155-MM, HE

M509A1, 8-INCH, HE

M864, 155-MM, HE, EXTENDED RANGE

FIROS-30, 122-MM, ICM

FIROS-25, 122-MM, ICM

M223, GRENADE FUZE, IMPACT

N.E.W. 33.00 G

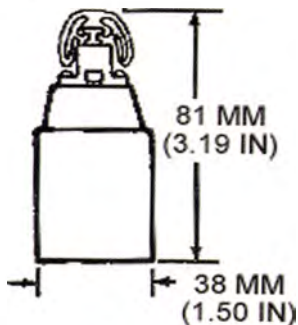

### U.S. GRENADE, DP, M46

Ordnance used with:

M483, 155-MM, HE

M483A1, 155-MM, HE

M509A1, 8-INCH, HE

M864, 155-MM, HE, EXTENDED RANGE

MK 146 MOD 2, 16-IN, HE

NR269, 155MM, ERFB-BB, HE-ICM

M223, GRENADE FUZE, IMPACT

N.E.W. 33.00 G

## YUGOSLAV GRENADE, DP, KB-1

Ordnance used with:  
ABABEL 50, 262MM, HE, M87  
KRTM-M93, RIFLE, 40MM, HEAT-APERS  
M93, 40MM, RIFLE, HEAT-APERS  
M87, 262MM, HE

N.E.W. 35.00 G

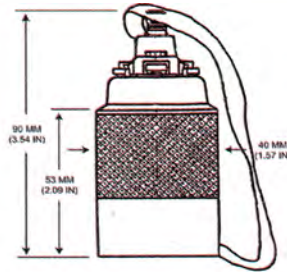

## U.S.S.R. BOMB, HEAT, PTAB-1M

Ordnance used with:  
KMGU  
KMGU-2, DISPENSER, CAPTIVE  
RBK-500 PTAB-1M, CBU  
BKF PTAB-1M, SUBMUN. CONTAINER UNIT, BOMB DIS...

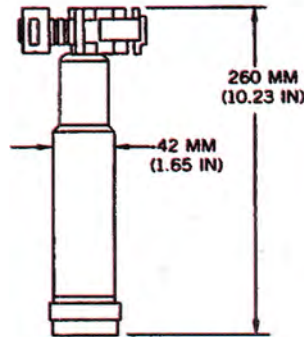

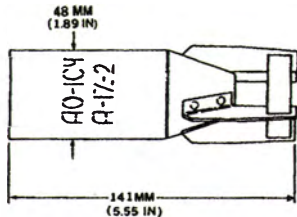

## U.S.S.R. BOMB, HE, AO-1 SCH

Ordnance used with:  
 AM-A, BOMB, NOSE  
 AM A B/V, BOMB, NOSE  
 RBK-250-275, DISP.

N.E.W. 51.00 G

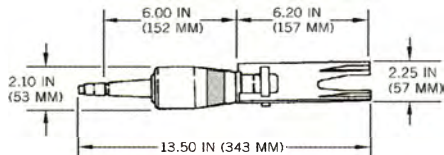

## U.S. BOMB, HEAT/FRAG, MK 118 MODS 0 & 1

Ordnance used with:  
 MK 7 MOD 2, DISP.  
 MK 7 MOD 3, DISP.  
 MK 7 MOD 4, DISP.  
 MK 7 MOD 6, DISP.  
 GRM, CLUSTER, GUIDED ROCKEYE MUNITION  
 MK 20 MOD 2 CBU  
 MK 20 MOD 3 CBU

N.E.W. 175.00 G

## U.S. BOMB, HEAT/FRAG, VECP MODIFIED

Ordnance used with:

MK 7 MOD 2, DISP.

MK 7 MOD 3, DISP.

MK 7 MOD 4, DISP.

MK 7 MOD 6, DISP.

MK 20 MOD 4 CBU

KMU-388/B, LASER GUIDANCE KIT,

MK 96 MOD 0, ELEC. DET.

N.E.W. 185.50 G

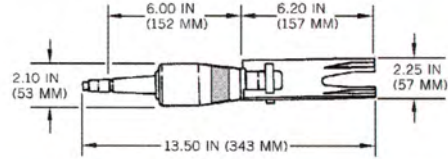

## U.S.S.R. BOMB, HEAT/FRAG, PTAB-2.5KO

Ordnance used with:

KMGU

KMGU-2, DISPENSER, CAPTIVE

I-351A, IMPACT

I-351AM, IMPACT, SD

BKF PTAB-2.5 KO, SUBMUN. CTR UNIT, BOMB DISPE...

N.E.W. 200.00 G

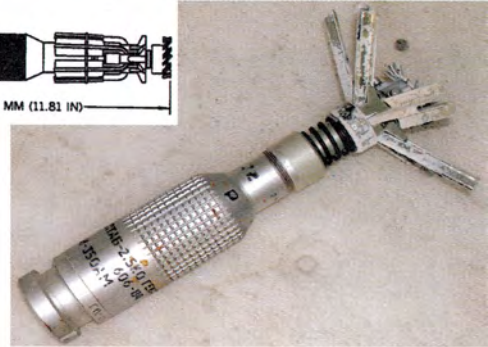
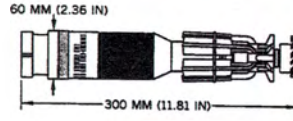

## U.S.S.R. LANDMINE, APERS, PFM-1 (BIRDMINE)

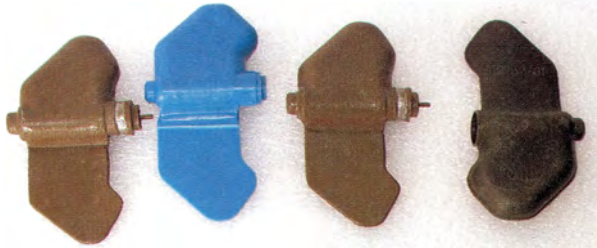

Ordnance used with:

KMGU

KMGU-2, DISPENSER, CAPTIVE

PKM, PORTABLE LANDMINE DISPENSING SYS.

KSF-1, SUBMUN. CANNISTER, MINE DISPENSING, EX...

---

## U.S.S.R. LANDMINE, SCATTERABLE, AT, PTM-1 (PGMDM)



Ordnance used with:

KMGU

KMGU-2, DISPENSER, CAPTIVE

9M27K2, 220 MM, CARGO

MVDM, TIME/PRESSURE/SD

9N128K2, WARHEAD, 220MM, CARGO

BKF PTM-1S, SUBMUN. CONTAINER UNIT, MINE DISP...

**U.S. BOMB UNITS, LIVE, FRAG/HEAT, BLU-97/B,  
BLU-97A/B, AND BLU-97B/B; BOMB UNITS, TRAINING,  
BLU-97(T-1)/B, BLU-97(T-1)A/B, BLU-97(T-2)/B**

Ordnance used with:  
SUU-65/B, DISP.

MK 10 MOD 0, MISSILE CANISTERING SYS. (USED ...  
RGM-109D-3, GUIDED MISSILE, S-TO-S (TOMAHAWK)  
RGM-109D-31, GUIDED MISSILE, S-TO-S (TOMAHAWK)  
RGM-109D-4, GUIDED MISSILE, S-TO-S (TOMAHAWK)  
RGM-109D-41 GUIDED MISSILE, S-TO-S (TOMAHAWK)  
UGM-109D-1, GUIDED MISSILE, SUBMARINE-TOSURFA...

N.E.W. 10.00 OZ

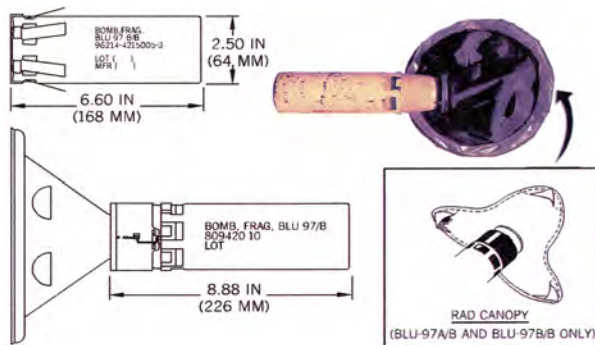

**U.S.S.R. BOMB, FRAG, 1.5-KG, MODEL UNKNOWN**

Ordnance used with:  
PROSAB-250, CBU

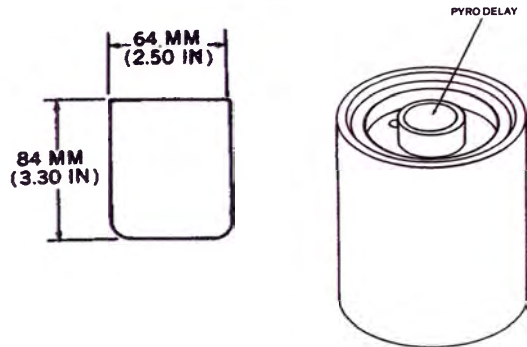

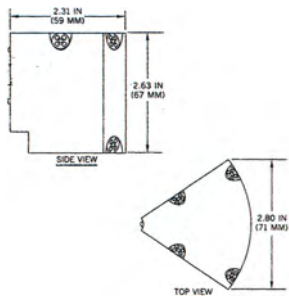

## U.S. LANDMINE, APERS, M86

N.E.W. 21.00 G

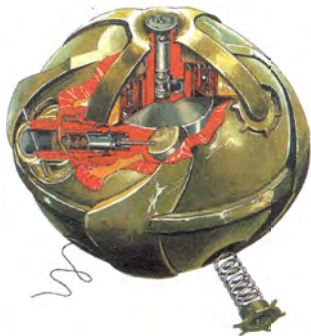

## U.S.S.R. LANDMINES, APERS, POM-1 AND POM-1S

Ordnance used with:

KMGU

KMGU-2, DISPENSER, CAPTIVE

PKM, PORTABLE LANDMINE DISPENSING SYS.

KSO-1, SUBMUN. CANISTER, MINE DISPENSING, EXP...

KSO-1S, SUBMUN. CANISTER, MINE DISPENSING, EX...

PKPI, DISPENSER, CAPTIVE, HELICOPTER MOUNTED

PKPI-1

N.E.W. 100.00 G

**ITALIAN LANDMINE, APERS, ANTI-DISTURBANCE,  
SB-33/AR; PORTUGUESE M412; SPANISH P-5; AND  
GREEK EM-20**

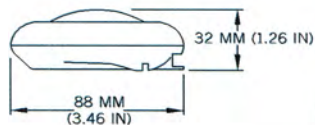
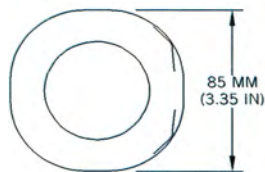

N.E.W. 17.00 G

**ITALIAN LANDMINE, APERS, SB-33; PORTUGUESE  
M412; AND SPANISH P-5**

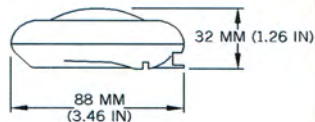
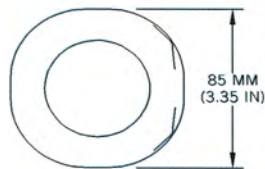

N.E.W. 36.00 G

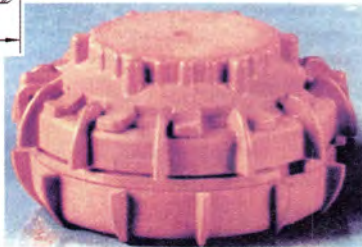
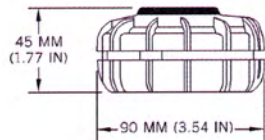

### EGYPTIAN LANDMINE, APERS, T/79

Ordnance used with:  
VS-AR4, ANTILIFT DEVICE

N.E.W. 54.00 G

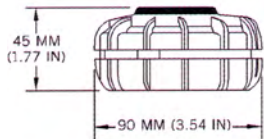

### IRANIAN LANDMINE, APERS, YM-I

Ordnance used with:  
VS-AR4, ANTILIFT DEVICE

N.E.W. 54.00 G

## ITALIAN LANDMINE, APERS, VS-50; AND TRAINING

Ordnance used with:  
VS-AR4, ANTILIFT DEVICE

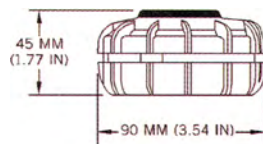

N.E.W. 44.00 G

## ITALIAN LANDMINES, APERS TS-50; AND TRAINING

Ordnance used with:  
VS-AR4, ANTILIFT DEVICE

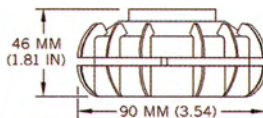

N.E.W. 54.00 G

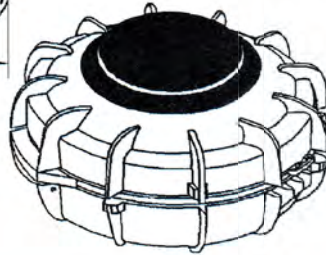
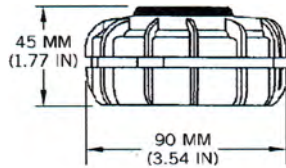

**SINGAPORE LANDMINE; APERS, SPM-1**

N.E.W. 44.00 G



**U.S.S.R. BOMB, HE, FRAG, AO-25-33**

N.E.W. 6.25 KG

## U.S.S.R. CANISTER, MINE-DISPENSING, KPFM-1

Ordnance used with:

KMGU

KMGU-2, DISPENSER, CAPTIVE

PFM-1, LANDMINE, APERS

BKF PFM-1, SUBMUN. CONTAINER UNIT, CANISTER D...

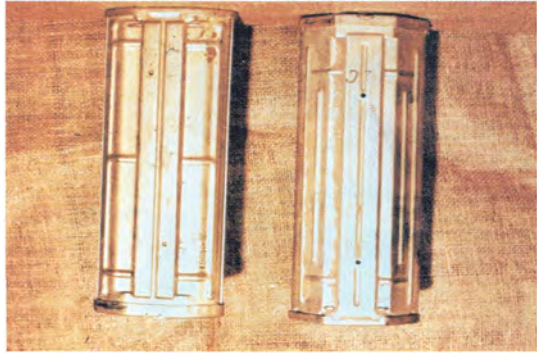

## U.S.S.R. CANISTER, MINE-DISPENSING, KPFM-1S

Ordnance used with:

KMGU

KMGU-2, DISPENSER, CAPTIVE

BKF PFM-1S, SUBMUN. CONTAINER UNIT, CANISTER ...



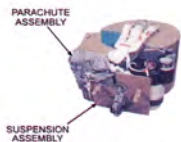

"Image from Russian Arms Catalog, Vol. 7, reproduced with Permission from Military Parade Publishing House."

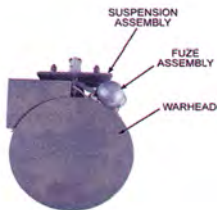

## U.S.S.R. BOMB, THERMOBARIC, BKF ODS-OD, PARACHUTE ASSEMBLY, ODS-OD

Ordnance used with:

KMGU  
 KMGU-2, DISPENSER, CAPTIVE  
 BKF ODS-OD, BOMB, THERMOBARIC  
 MDL. UNK. (ODS-OD)  
 MDL. UNKNOWN, CYLINDER  
 MDL. UNKNOWN, BURSTER/IGNITER ASSY.  
 BKF ODS-OD SUBMUN. CONTAINER UNIT, BOMB DISPE...



## U.S.S.R. LANDMINE, APERS, POM-2S

Ordnance used with:

9M18, 122 MM, MINE DISPENSING, APERS  
 PKM, PORTABLE LANDMINE DISPENSING SYS.  
 PKPI, DISPENSER, CAPTIVE, HELICOPTER MOUNTED  
 PKPI-1  
 UMZ, MULTI-PURPOSE MINE LAYER





# Afghanistan

Ordnance Identification Guide