

# HANDBOOK OF AMMUNITION USED IN KURDISTAN AND SURROUNDING AREAS



**KURDISTAN**



**FEBRUARY 2009**

## TABLE OF CONTENTS

	SECTION
GENERAL INFORMATION	A
GRENADES	B
INFANTRY WEAPONS	C
MINES	D
FIRING DEVICES	E
MORTAR AMMUNITION	F
PROJECTILES	G
ROCKETS	H
FUZES	I
BOMBS AND SUBMUNITIONS	J
MISSILES	K

# SECTION A

## GENERAL INFORMATION

- ◆ TRANSLATIONS
- ◆ FILLER CODES
- ◆ ORDNANCE MARKINGS
- ◆ PROJECTILE CUTAWAYS
- ◆ SOVIET BOMB MARKINGS
- ◆ MODEL MARKINGS FOR MINES
- ◆ MARKINGS FOR BOMBS
- ◆ 9M CODE CROSS REFERENCE

**TRANSLATION TABLE  
FORMER SOVIET UNION**

<b>CYRILLIC</b>	<b>ENGLISH</b>	<b>CYRILLIC</b>	<b>ENGLISH</b>
<b>А</b>	<b>A</b>	<b>П</b>	<b>P</b>
<b>Б</b>	<b>B</b>	<b>Р</b>	<b>R</b>
<b>В</b>	<b>V</b>	<b>С</b>	<b>S</b>
<b>Г</b>	<b>G</b>	<b>Т</b>	<b>T</b>
<b>Д</b>	<b>D</b>	<b>У</b>	<b>U</b>
<b>Е</b>	<b>E</b>	<b>Ф</b>	<b>F</b>
<b>Ж</b>	<b>ZH</b>	<b>Х</b>	<b>KH</b>
<b>З</b>	<b>Z</b>	<b>Ц</b>	<b>TS</b>
<b>И</b>	<b>I</b>	<b>Ч</b>	<b>CH</b>
<b>Й</b>	<b>Y</b>	<b>Ш</b>	<b>SH</b>
<b>К</b>	<b>K</b>	<b>Щ</b>	<b>SHICH</b>
<b>Л</b>	<b>L</b>	<b>Ъ (1)</b>	<b>Y</b>
<b>М</b>	<b>M</b>	<b>Ы (2)</b>	<b>Y</b>
<b>Н</b>	<b>N</b>	<b>Э (3)</b>	<b>E</b>
<b>О</b>	<b>O</b>	<b>ю</b>	<b>YU</b>
		<b>Я</b>	<b>YA</b>

**NOTES:**

1. Pronounced Y as in wilco
2. Pronounced Y as in yellow
3. Pronounced E as in echo

**AMMUNITION FILLER CODES  
FORMER SOVIET UNION**

<b>RUSSIAN</b>	<b>ENGLISH</b>	<b>MEANING</b>
A	A	Amatol (100% ammonium nitrate)
A-40	A-40	Amatol (40% ammonium nitrate, 60% TNT)
AT-40	AT-40	Amatol (40% ammonium nitrate, 60% TNT pressed)
A-80	A-80	Amatol (80% ammonium nitrate, 20% TNT)
AT-90	AT-90	Amatol (90% ammonium nitrate, 10% TNT pressed)
ATФ-40	ATF-40	TNT (40% Ammonium nitrate, 60% TNT pressed)
A-IX-1	A-9-1	RDX 94%, and Wax 6%
A-IX-2	A-9-2	RDX 73%, aluminum 23%, wax 4%
A-IX-20	A-9-20	RDX 78%, aluminum 19%, wax 3%
A-IX-II	A-9-P	RDX with unknown suffix "P"
ДБ	DB	Dinitrobenzol
ДБТ	DBT	Dinitrobenzene and TNT
Г	G	Hexogen (cyclonite, RDX)
ГАИ-30	GAI-30	RDX 30%
З	Z	Incendiary
М	M	Picric acid
МС	MS	TNT/AL/RDX
К-1	K-1	TNT 70% dinitrobenzene 30%
К-2	K-2	TNT 80% dinitrobenzene 20%
ОКТОГЕН	Octogen	HMX
ОКФОЛ	OKFOL	HMX 95%, wax 5% (normal composition)
ОКТОЛ	OKTOL	HMX and TNT
ОЛ	OL	HMX 95%, wax 5% (normal composition)
ПВВ-5А	PVV-5A	Plastic Explosive
Т	T	Trotyl (TNT)
Т-80	T-80	TNT 80%, RDX 20%
ТГ	TG	TNT and RDX
ТГ-30	TG-30	TNT 30%, Hexogen (RDX) 70%
ТГ-50	TG-50	TNT 50%, Hexogen (RDX) 50%
ТГАФ-5	TGAF-5	TNT 40%, RDX 40%, aluminum 20%
ТГАГ-5	TGAG-5	TNT 60%, RDX 20%, aluminum 15%, wax 5%
ТД-42	TD-42	TNT 42%, dinitronaphthalene 58%
ТД-50	TD-50	TNT 50%, dinitronaphthalene 50%
ТДУ	TDU	TNT with spotting charge
ТС	TS	TNT sulfite
Ш	Sh	Schneiderite (ammonium nitrate 88% naphthalene 12%)

## AMMUNITION FILLER CODES FORMER SOVIET UNION Cont//

RUSSIAN	ENGLISH	MEANING
ШТ	ShT	Schneiderite and TNT
P-4	R-4	White and yellow phosphorus
P-5	R-5	Mustard gas
PC	RS	Lewisite gas
PIO	Ryu	Phosgene gas
P-15	R-15	Adamsite gas
P-2	R-2	Hydrocyanic (AC) Gas
P-35	R-35	Sarin (GB) Gas
P-43	P-43	Lewisite Gas
P-55	P-55	Soman (GD) Gas
P-74	P-74	Mustard Gas
PK-7	RK-7	Mustard/Lewisite Mixture

### RUSSIAN BOX MARKINGS

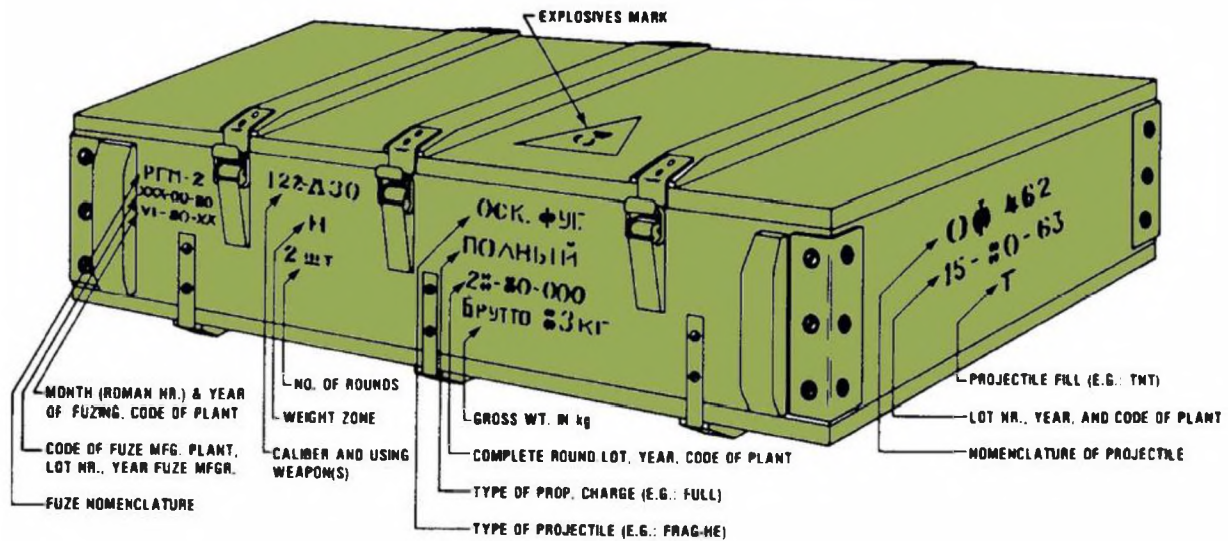

## CALIBRE DETERMINATION THROUGH NOMENCLATURE FORMER SOVIET UNION

The calibre of projectiles manufactured by the former Soviet Union can often be determined by reading the first two digits of the nomenclature. This method is by no means absolute; however it will often be effective.

<b>1<sup>st</sup> &amp; 2<sup>nd</sup> digit of nomenclature</b>	<b>Caliber of using weapon</b>
<b>13</b>	<b>25mm</b>
<b>16</b>	<b>37mm</b>
<b>24</b>	<b>45mm</b>
<b>27</b>	<b>57mm</b>
<b>28</b>	<b>57mm</b>
<b>34</b>	<b>76mm</b>
<b>35</b>	<b>76mm</b>
<b>36</b>	<b>76mm</b>
<b>36</b>	<b>85mm</b>
<b>41</b>	<b>100mm</b>
<b>42</b>	<b>107mm</b>
<b>46</b>	<b>122mm</b>
<b>47</b>	<b>122mm</b>
<b>48</b>	<b>130mm</b>
<b>50</b>	<b>152mm</b>
<b>53</b>	<b>152mm</b>
<b>54</b>	<b>152mm</b>
<b>57</b>	<b>180mm</b>
<b>62</b>	<b>203mm</b>
<b>67</b>	<b>280mm</b>
<b>82</b>	<b>82mm</b>
<b>84</b>	<b>107mm</b>
<b>84</b>	<b>120mm</b>

### **EXAMPLE:**

**A Projectile of Soviet manufacture with the nomenclature O-412 would indicate, Fragmentation, 100mm.**

**MARKINGS FOR AMMUNITION  
FORMER SOVIET UNION**

<b>CYRILLIC</b>	<b>ENGLISH</b>	<b>MEANING</b>
<b>А</b>	<b>A</b>	<b>PROPAGANDA OR FRAGMENTATION</b>
<b>Б</b>	<b>B</b>	<b>ARMOR PIERCING</b>
<b>З</b>	<b>Z</b>	<b>INCENDIARY</b>
<b>Р</b>	<b>R</b>	<b>TRACER</b>
<b>Д</b>	<b>D</b>	<b>SMOKE</b>
<b>Ф</b>	<b>F</b>	<b>HIGH EXPLOSIVE (Fugaasnymi)</b>
<b>О</b>	<b>O</b>	<b>FRAGMENTATION (Oskolochno)</b>
<b>С</b>	<b>S</b>	<b>ILLUMINATION</b>
<b>Г</b>	<b>G</b>	<b>CONCRETE PIERCING</b>
<b>Х</b>	<b>Kh</b>	<b>GAS</b>
<b>БМ</b>	<b>BM</b>	<b>AP DISCARDING SABOT</b>
<b>ДЦ</b>	<b>DTs</b>	<b>TARGET MARKER SMOKE</b>
<b>БК</b>	<b>BK</b>	<b>HIGH EXPLOSIVE ANTITANK</b>
<b>БП</b>	<b>BP</b>	<b>HIGH EXPLOSIVE ANTITANK</b>
<b>РПО</b>	<b>RPO</b>	<b>INFANTRY FLAME ROCKET</b>
<b>З</b>	<b>Z</b>	<b>INCENDIARY</b>
<b>ИНЕРТ</b>	<b>INERT</b>	<b>INERT</b>
<b>МАКЕТ</b>	<b>MAKET</b>	<b>MODEL</b>
<b>ОСКОЛ</b>	<b>OSKOL</b>	<b>FRAGMENTATION</b>
<b>ПРАКТ</b>	<b>PRACT</b>	<b>PRACTICE</b>

**These markings are often used in strings of two or more letters to designate the type of ordnance. Following the letters will be numbers to indicate the model number.**

**For example:**

<b>ОФ 412</b>	<b>OF 412</b>	<b>FRAGMENTATION HIGH EXPLOSIVE MODEL 412</b>
<b>БР 350</b>	<b>BR 350</b>	<b>ARMOR PIERCING TRACER MODEL 350</b>
<b>БЗ 882</b>	<b>BZ 882</b>	<b>ARMOR PIERCING INCENDIARY MODEL 882</b>
<b>ОФР 512</b>	<b>OFR 512</b>	<b>FRAGMENTATION HIGH EXPLOSIVE WITH TRACER MODEL 512</b>

# MARKINGS FOR PROJECTILES FORMER SOVIET UNION

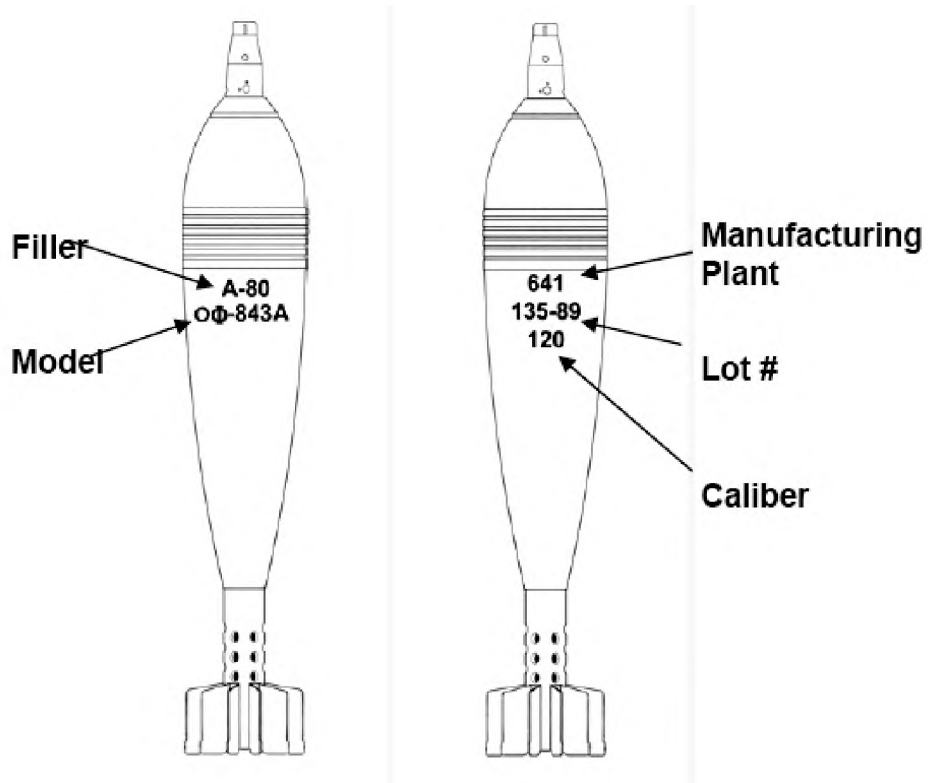

# MARKINGS FOR PROJECTILES FORMER SOVIET UNION

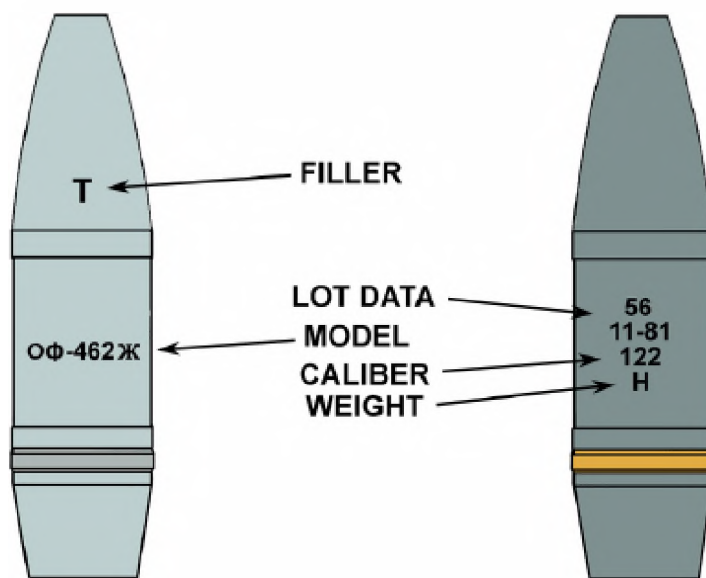

## TYPICAL MODEL MARKING FOR MINES FORMER SOVIET UNION

CYRILLIC	ENGLISH	MEANING
Б	B	LARGE OR PAPER
В	V	FUZE
Д	D	WOODEN
Э	E	ELECTRICAL
З	Z	OBSTACLE
К	K	SHAPED CHARGE
М	M	MINE, METAL, OR IMPROVED
Н	N	ANTI-HANDLING, TREAD OPERATED, OR DIRECTIONAL
О	O	FRAGMENTATION OR OBSTACLE
П	P	ANTI-PERSONNEL OR PLASTIC
С	S	SELF DESTRUCT OR BOOBY TRAP
Т	T	ANTI-TANK
У	U	TRAINING
Ф	F	EXPLOSIVE, FUEL AIR EXPLOSIVE OR AIR DROPPED
Х	Kh	CHEMICAL
Ч	Ch	CLOCKWORK OR TIMER
Ш	Sh	TILT ROD
Я	Ya	BOX (OLD DESIGNATION) OR ANCHORED
Р	R	WATER

These designations are often strung together to form the nomenclatures of mines and their fuzes. Examples of this plus several that don't follow the system are shown below.

МВЗ	MVZ	MINE FUZE PRESSURE OPERATED
ЯМ	YaM	ANTI-TANK MINE WOODEN (OLD DESIGNATION)
МШМ	MPM	MINE - BULLET - IMPROVED
ЭХЗ	E kh Z	ELECTRIC CHEMICAL FUZE
ЧЗ	ChZ	CLOCKWORK/TIMER FUZE
МВЧ	MVCh	CLOCKWORK MINE FUZE
УВ	UV	PULL FUZE

**TYPICAL MODEL MARKING FOR MINES  
FORMER SOVIET UNION Cont//**

<b>МВШ</b>	<b>MVSh</b>	<b>MINE FUZE TILT ROD</b>
<b>ОЗМ</b>	<b>OZM</b>	<b>FRAGMENTATION OBSTACLE MINE</b>
<b>ТМД-Б</b>	<b>TMD-B</b>	<b>ANTI-TANK MINE WOODEN CASED</b>
<b>ЗТ</b>	<b>ZT</b>	<b>TIME FUZE IGNITER</b>
<b>МУВ</b>	<b>MUV</b>	<b>MINE FUZE PULL</b>
<b>ТМК</b>	<b>TMK</b>	<b>ANTI-TANK MINE WITH SHAPED CHARGE</b>
<b>ПМД</b>	<b>PMD</b>	<b>ANTI-PERSONNEL MINE WOODEN CASED</b>
<b>ПОМЗ</b>	<b>POMZ</b>	<b>ANTI-PERSONNEL MINE OBSTACLE</b>
<b>ПМН</b>	<b>PMN</b>	<b>ANTI-PERSONNEL MINE TREAD OPERATED</b>
<b>ВПФ</b>	<b>VPF</b>	<b>ALL WAYS ACTING FUZE</b>
<b>ТМБ</b>	<b>TMB</b>	<b>ANTI-TANK MINE PAPER CASED</b>
<b>ТМ</b>	<b>TM</b>	<b>ANTI-TANK MINE</b>
<b>МВ</b>	<b>MV</b>	<b>MINE FUZE PRESSURE OPERATED</b>
<b>МВМ</b>	<b>MVM</b>	<b>MINE FUZE IMPROVED</b>
<b>МВН</b>	<b>MVN</b>	<b>MINE FUZE MAGNETIC INFLUENCE</b>
<b>ТМН</b>	<b>TMN</b>	<b>ANTI-TANK MINE WITH ANTI HANDLING FUZE</b>
<b>МОН</b>	<b>MON</b>	<b>MINE FRAGMENTATION DIRECTIONAL</b>

**MARKINGS FOR BOMBS  
FORMER SOVIET UNION**

<b>CYRILLIC</b>	<b>ENGLISH</b>	<b>MEANING</b>
<b>ФАБ</b>	<b>FAB</b>	<b>GENERAL PURPOSE</b>
<b>БРАБ</b>	<b>BRAB</b>	<b>SEMI-ARMOR PIERCING</b>
<b>БЕТАБ</b>	<b>BETAB</b>	<b>ARMOR PIERCING</b>
<b>ПТАБ</b>	<b>PTAB</b>	<b>ANTI-TANK</b>
<b>МАБ</b>	<b>MAB</b>	<b>LIGHT CASE BLAST</b>
<b>АО</b>	<b>AO</b>	<b>FRAGMENTATION</b>
<b>ЗАБ</b>	<b>ZAB</b>	<b>INCENDIARY</b>
<b>РРАБ</b>	<b>RRAB</b>	<b>CONTAINER (CLUSTER)</b>
<b>ХАБ</b>	<b>KhAB OR ChAB</b>	<b>CHEMICAL</b>
<b>КРАБ</b>	<b>KRAB</b>	<b>TOXIC SMOKE</b>
<b>ДАБ</b>	<b>DAB</b>	<b>INCENDIARY SMOKE</b>
<b>САБ</b>	<b>SAB</b>	<b>FLARE</b>
<b>ФОТАБ</b>	<b>FOTAB</b>	<b>PHOTO FLASH</b>
<b>АНАБ</b>	<b>ANAB</b>	<b>MARKER FLOAT</b>
<b>АБ</b>	<b>AB</b>	<b>PROPAGANDA</b>
<b>ДС</b>	<b>DS</b>	<b>ROCKET ASSISTED</b>
<b>АОХ</b>	<b>AOKh OR AOCh</b>	<b>FRAG-CHEMICAL</b>

## MARKINGS FOR FUZES (CHINESE PROJECTILES)

The Chinese have begun to mark their fuzes made for export with Roman characters rather than Chinese. Fuzes copied by the Chinese will carry the marking system used by the country that developed it. Therefore fuzes will be found that are of Chinese manufacture but with Soviet or U.S. markings.

- MD = Proximity or Piezoelectric
- MJ = Point Detonating (rockets)
- ML = Point Detonating (artillery projectiles)
- MP = Point Detonating (mortars)
- MS = Time and Mechanical Time (artillery and mortars)

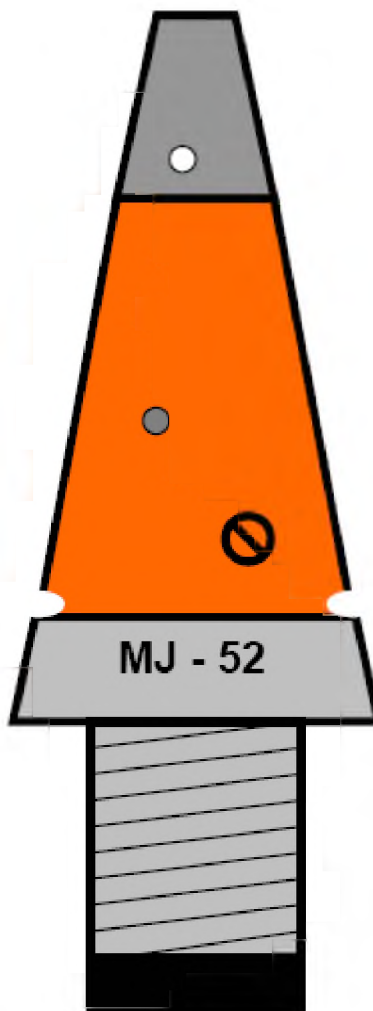

## **MARKINGS FOR PROJECTILES (FRANCE)**

**A = TOXIC**  
**AC = ANTI-TANK**  
**AP = ANTI-PERSONNEL**  
**AV = ANTI-VEHICLE**  
**DUMMY = DUMMY**  
**E = EXPLOSIVE**  
**Ecl = ILLUMINATING**  
**Fum = SMOKE**  
**GC = HIGH CAPACITY**  
**Inc = INCENDIARY**  
**O = PROJECTILE (OBUS)**  
**PA = WITH ADDITIONAL PROPULSION**  
**Ra = ECHO-RADAR**  
**RO = ROCKET**  
**X = PRACTICE/EXCERSISE**  
**PRPA = ROCKET ASSISTED**  
**FL = APFSDS**  
**CC = SHAPED CHARGE (Charge Creuse)**  
**DR = CANISTER**  
**BT = BOAT TAIL**  
**BB = BASE BLEED**  
**ER = EXTENDED RANGE**  
**FB = FULL BORE**  
**HB = HOLLOW BASE**  
**CCC = COMBUSTIBLE CARTRIDGE CASE**  
**OXAS = PROJECTILE EXERCISE AIR TO GROUND**  
**OMEI = PROJECTILE MINE EXPLOSIVE INCENDIARY**  
**OXL = PROJECTILE EXERCISE INERT LOADED**  
**OXT = PROJECTILE EXERCISE WITH TRACER**

## **MARKINGS FOR FUZES (FRANCE PROJECTILES)**

**AD = SELF DESTRUCT**  
**D = DETONATOR**  
**De = DELAY**  
**DE = MECHANICAL TIME SUPERQUICK / PROXIMITY**  
**DUMMY = DUMMY**  
**EI = ELECTRIC**  
**Fu = NOSE FUZE**  
**FuC = BASE FUZE**  
**FuT = TIME FUZE**  
**I = INSTANTANEOUS/POINT DETONATING**  
**Ra = RADIOELECTRIC**  
**X = TRAINING**

**EXAMPLE: FU-I-40 = Nose fuze-Instantaneous-Model 40**

# MARKINGS FOR PROJECTILES (FRANCE) Continued//

EXAMPLES: OE 81 32 = Projectile Explosive 81mm Model 32  
Nomenclature may be shortened to 81-32  
RO AC 73-50 = Rocket Anti-Tank 73mm Model 1950  
OX 81 55 = Projectile practice 81mm Model 55

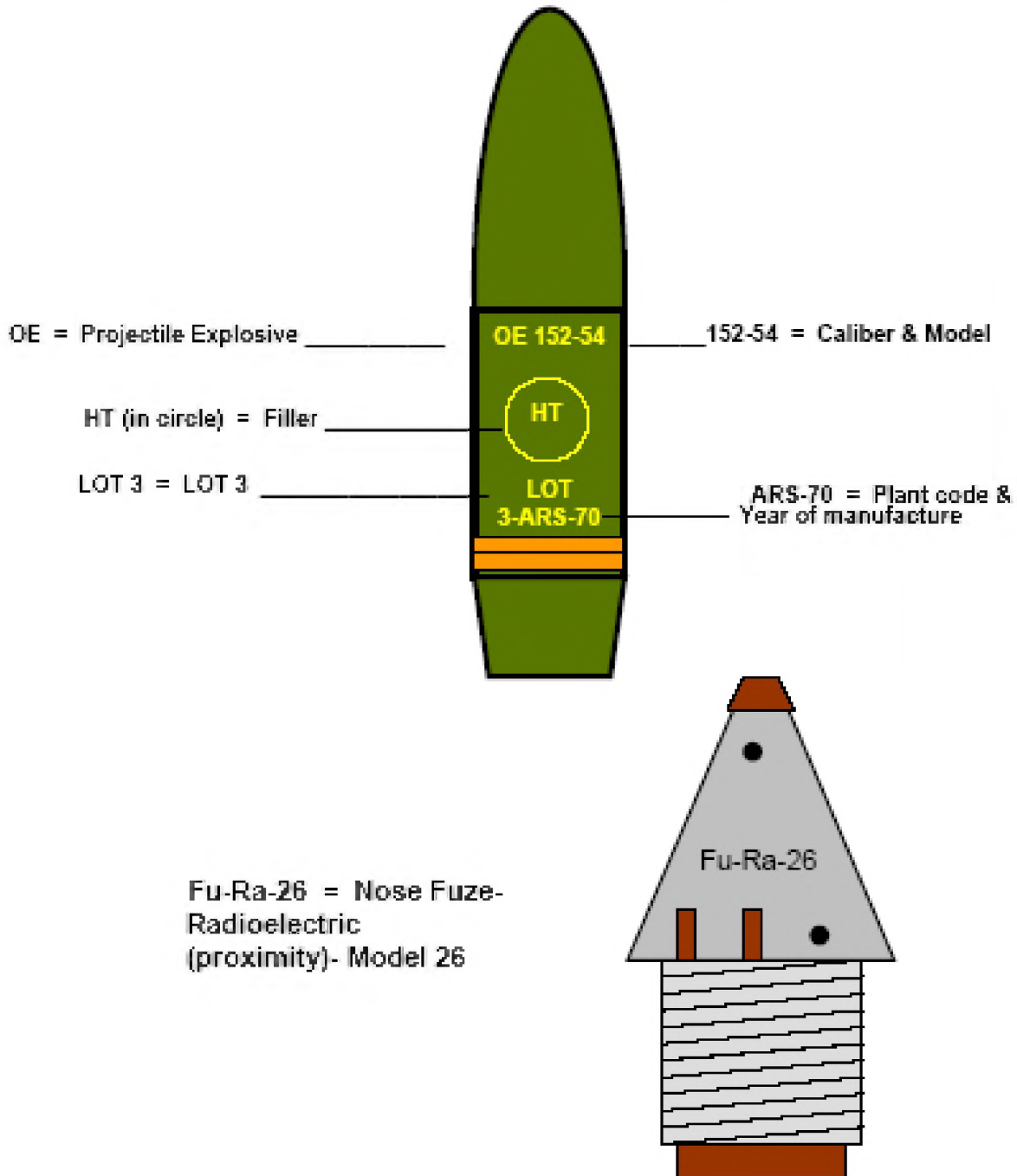

## MARKINGS FOR FUZE (YUGOSLAVIA PROJECTILES)

BU = PROXIMITY  
 DDM – MECHANICAL TIME  
 DDP = IMPACT PYROTECHNIC TIME  
 DI = BASE INERTIA  
 DT = BASE TIME  
 SM = MECHANICAL SELF DESTRUCT  
 SP = PYROTECHNIC SELF DESTRUCT  
 TK = TECHNICAL CONTROL  
 TM = MECHANICAL TIME  
 TP = PYROTECHNIC TIME  
 TR = TIME FUZE (FOR ROCKETS)  
 UT = IMPACT  
 UTE = ELECTRONIC TIME  
 UTI = IMPACT INERTIA  
 UTIU = IMPACT INERTIA WITH DELAY  
 UT-PE = IMPACT WITH PIEZOELECTRIC CRYSTAL  
 UTU = IMPACT WITH DELAY  
 cek = SECONDS  
 (M) = COPY OF HUNGARIAN FUZE  
 (N) = COPY OF GERMAN FUZE  
 (S) = COPY OF SOVIET FUZE  
 NOTE: Designations may be found in English or Cyrillic characters.

### YUGOSLAVIAN FUZE EXAMPLE

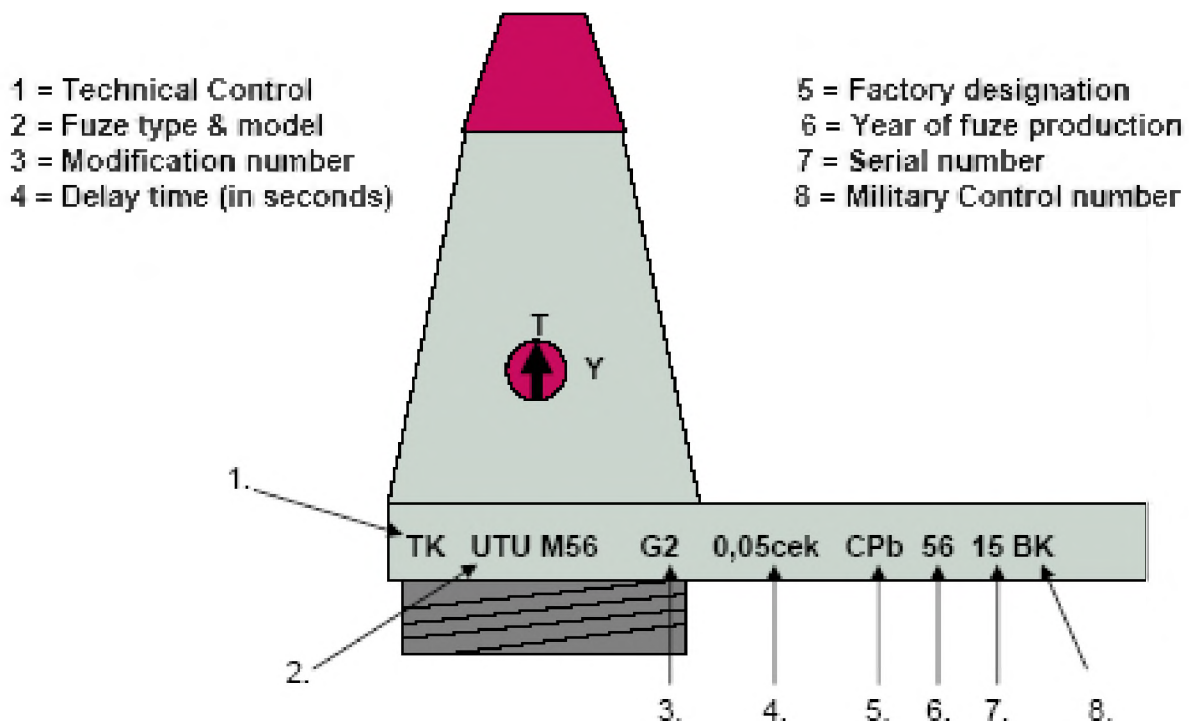

## TYPICAL MODEL MARKINGS FOR MINES (FORMER SOVIET UNION)

<u>CYRILLIC</u>	<u>ENGLISH</u>	<u>MEANING</u>
Б	B	LARGE OR PAPER
В	V	FUZE
Д	D	WOODEN
Э	E	ELECTRICAL
З	Z	OBSTACLE
К	K	SHAPED CHARGE
М	M	MINE, METAL, OR IMPROVED
Н	N	ANTI-HANDLING, PRESSURE, OR DIRECTIONAL
О	O	FRAGMENTATION OR OBSTACLE
П	P	ANTI-PERSONNEL OR PLASTIC
С	S	SELF DESTRUCT OR BOOBY TRAP
Т	T	ANTI-TANK
У	U	TRAINING
Ф	F	EXPLOSIVE, FUEL AIR EXPLOSIVE OR AIR DROPPED
Х	Kh	CHEMICAL
Ч	Ch	CLOCKWORK OR TIMER
Ш	Sh	TILT ROD
Я	Ya	BOX (OLD DESIGNATION) OR ANCHORED
Р	R	WATER

These designations are often strung together to form the nomenclatures of mines and their fuzes. Examples of this plus several that don't follow the system are shown below.

МВЭ	MVZ	MINE FUZE PRESSURE OPERATED
ЯМ	YaM	ANTI-TANK MINE WOODEN OLD DESIGNATION
МПМ	MPM	MINE - BULLET - IMPROVED
ЭХЗ	E kh Z	ELECTRIC CHEMICAL FUZE
ЧЗ	ChZ	CLOCKWORK/TIMER FUZE
МВЧ	MVCh	CLOCKWORK MINE FUZE
УВ	UV	PULL FUZE
МВШ	MVSh	MINE FUZE TILT ROD
ОЗМ	OZM	FRAGMENTATION OBSTACLE MINE
ТМД-Б	TMD-B	ANTI-TANK MINE WOODEN CASED
ЗТ	ZT	TIME FUZE IGNITER
МУВ	MUV	MINE FUZE PULL
ТМК	TMK	ANTI-TANK MINE WITH SHAPED CHARGE
ПМД	PMO	ANTI-PERSONNEL MINE WOODEN CASED
ПОМЭ	POMZ	ANTI-PERSONNEL MINE OBSTACLE
ПМН	PMN	ANTI-PERSONNEL MINE PRESSURE
ВПФ	VPF	ALL WAYS ACTING FUZE
ТМБ	TMB	ANTI-TANK MINE PAPER CASED
ТМ	TM	ANTI-TANK MINE
МВ	MV	MINE FUZE PRESSURE OPERATED
МВМ	MVM	MINE FUZE IMPROVED
МВН	MVN	MINE FUZE MAGNETIC INFLUENCE
ТМН	TMN	ANTI-TANK MINE WITH ANTI HANDLING FUZE
МОН	MON	MINE FRAGMENTATION DIRECTIONAL

## TYPICAL MODEL MARKINGS FOR MINES (FORMER YUGOSLAVIA)

P = ANTI PERSONNEL  
T = ANTI TANK  
V = TRAINING  
A = PLASTIC/NON METALLIC  
D = WOODEN CASED  
RO = BOUNDING  
R = STAKE  
M = MINE / METAL  
U = FUZE  
H = CHEMICAL/FRICTION TYPE  
● = SKOLSKI (inert training mine)

### EXAMPLES:

PROM-3 = ANTI PERSONNEL MINE - BOUNDING -METAL CASED – MODEL 3

UTMAH = FUZE - ANTI TANK MINE – PLASTIC - CHEMICAL FRICTION

NOTE: A one inch yellow stripe on the mine indicates a training item.

## TYPICAL MODEL MARKINGS FOR MINES (ITALY)

MAUS = MINE ANTI PERSONNEL SCATTERABLE  
MATS = MINE ANTI TANK SCATTERABLE  
SATM = SCATTERABLE ANTI TANK MINE  
AR = ANTI DISTURBANCE  
AN = SELF NEUTRALIZING  
TC = TECHNOVAR (MANUFACTURER NAME)  
VS = VALSELLA (MANUFACTURER NAME)  
E = ELECTRONIC  
JAP = JUMPING ANTI PERSONNEL  
SAPFM = SCATTERABLE ANTI PERSONNEL FRAGMENTATION MINE  
DAFM = DIRECTIONAL ANTI PERSONNEL FRAGMENTATION MINE  
EXAMPLE: VS-50-AR = VALSELLA MODEL 50 ANTI DISTURBANCE

## TYPICAL MODEL MARKINGS FOR MINES (CZECHOSLOVAKIA)

PP = ANTIPERSONNEL  
MI = MINE  
BA = NON METALLIC  
D = WOOD  
SR = BOUNDING  
S = SCATTERABLE  
PT = ANTI TANK  
K = METAL CASED  
P = PLATE CHARGE  
EXAMPLE: PT-MI-BA-III = ANTI TANK MINE NON METALLIC MODEL 3

## TYPICAL MODEL MARKINGS FOR MINES (FRANCE)

AP = ANTI PERSONNEL  
 AC = ANTI TANK  
 X = PRACTICE  
 MI = MINE  
 CC = SHAPED CHARGE  
 CP = PLATE CHARGE  
 ID = NON METALLIC / UNDETECTABLE  
 DV = DETECTABLE AT WILL  
 MB = BOUNDING  
 ECL = ILLUMINATION  
 LDU = LONG DURATION  
 MLE = MODEL  
 PM = MECHANICALLY LAID (POSE MECHANIQUE)  
 EF = EFFECT  
 DR = DIRECTED  
 AH = ACTION HORIZONTAL (SIDE ATTACK)  
 HPD = HIGH DESTRUCTIVE POWER  
 EXAMPLE: MI-AC-X-7 = MINE ANTI TANK PRACTICE Model 7  
 MI-EF-DR = MINE DIRECTED EFFECT

## TYPICAL MODEL MARKINGS FOR BOMBS (FORMER SOVIET UNION)

<u>CYRILLIC</u>	<u>ENGLISH</u>	<u>MEANING</u>
ФАБ	FAB	GENERAL PURPOSE
БРАБ	BRAB	SEMI-ARMOR PIERCING
БЕТАБ	BETAB	ARMOR PIERCING
ПТАБ	PTAB	ANTI-TANK
МАБ	MAB	LIGHT CASE BLAST
АО	AO	FRAGMENTATION
ЗАБ	ZAB	INCENDIARY
РРАБ	RRAB	CONTAINER (CLUSTER)
ХАБ	KhAB OR ChAB	CHEMICAL
КРАБ	KRAB	TOXIC SMOKE
ДАБ	DAB	INCENDIARY SMOKE
САБ	SAB	FLARE
ФОТАБ	FOTAB	PHOTO FLASH
АНАБ	ANAB	MARKER FLOAT
АБ	AB	PROPAGANDA
ДС	DS	ROCKET ASSISTED
АОХ	AOKh OR AOCh	FRAG-CHEMICAL

## PROJECTILE CUTAWAYS

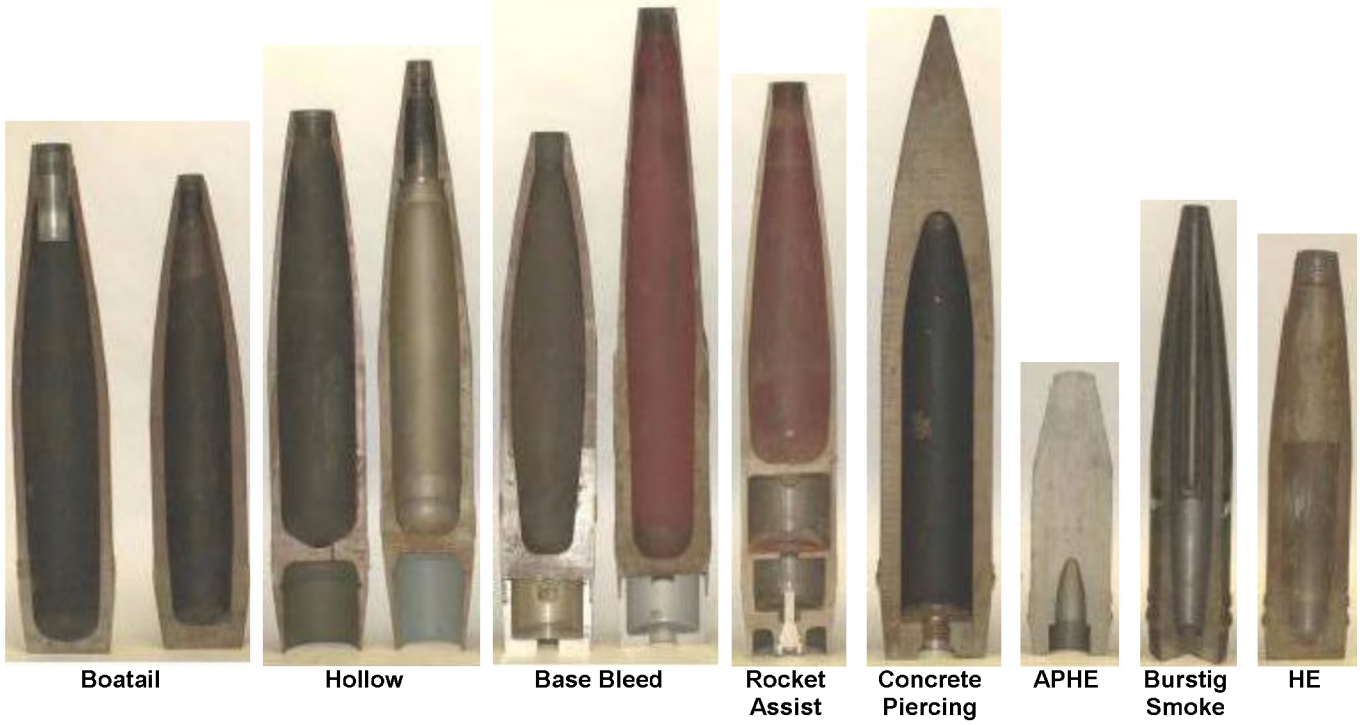

## PROJECTILE BASES



## PROJECTILE BASES



## TYPICAL BOMB MARKINGS

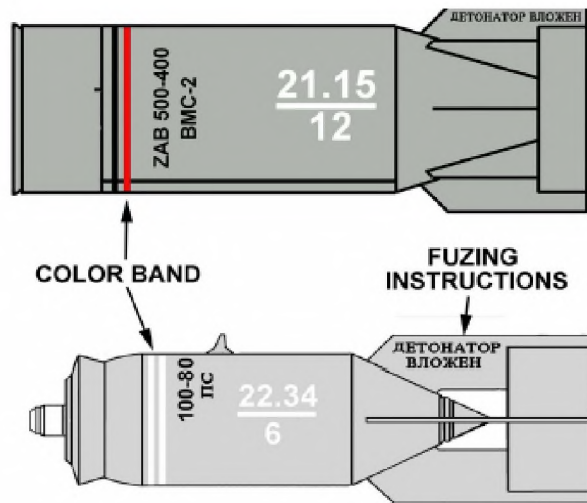
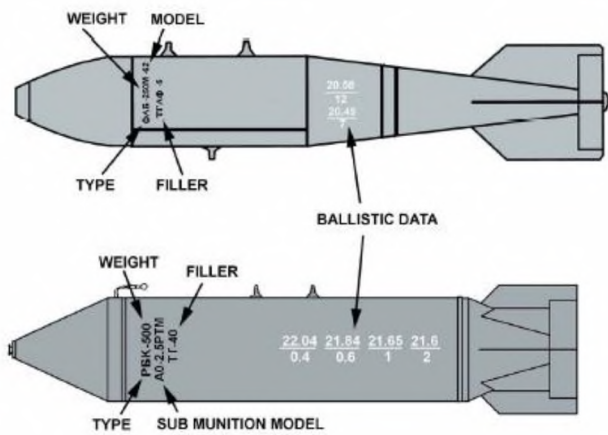

## RUSSIAN 9M NOMENCLATURE CROSS REFERENCE

### AT-3 SAGGER



### 122mm ROCKETS

9M Number	DESCRIPTION
9M519-1-7	122mm CARRIER, Radio Jammer
9M22	122mm HE/FRAG 6.4KG WARHEAD
9M22M	122mm HE/FRAG 18.4KG WARHEAD
9M22U	122mm HE/FRAG 19.4KG WARHEAD
9M28F	122mm HE/FRAG 19.4KG WARHEAD (CUT STEEL FRAG)
9M28K	122mm CARRIER, 3 AT or 5 AP MINES
9M42	122mm CARRIER, ILLUM
9M43	122mm CARRIER, SMOKE
9M53	122mm ENHANCED BLAST 26 KG PARACHUTE RETARDED
9M217	122mm CARRIER, 2 TOP-ATTACK SUBMUNITIONS
9M218	122mm CARRIER, 45 DUAL PURPOSE SUBMUNITIONS
9M521	122mm HE/FRAG 21KG WARHEAD (BALL BEARING FRAG)
9M522	122mm HE PARACHUTE RETARDED FRAG WARHEAD

### 220mm ROCKETS

ROCKET 9M#	WARHEAD 9N#	DESCRIPTION
9M27F9	9N218F	HE/FRAG 100KG WARHEAD
9M27K/9M27K1	9N218K1	CARRIER, 30 9N210 DP SUBMUNITIONS
9M27K2	9N218K2	CARRIER, 24 PTM-1S AT MINES
9M27K3	9N218K3	CARRIER, 312 PFM-1 AP MINES
9M59	UNK	CARRIER, 9 PTM-3S AT MINES

**300mm ROCKETS**

<b>ROCKET 9M#</b>	<b>WARHEAD 9N#</b>	<b>DESCRIPTION</b>
9M55 & 9M528	9N150	HE/FRAG PARACHUTE-STABILIZED
9M55K & 9M525	9N139	CARRIER, 72, 9N235 HE/FRAG BOMBLETS
9M55K1 & 9M526	9N152	CARRIER, 5 MOTIV-3M SMART BOMBLETS
9M55K4 & 9M527	9N539	CARRIER, 25 AT MINES
9M55K5 & 9M531	9N176	CARRIER, 646 DUAL-PURPOSE SUBMUNITIONS
9M55S & 9M529	9N174	ENHANCED BLAST, 100KG FUEL-AIR Exp
9M530	NA	PENETRATOR, 75 KG HE

**544mm ROCKETS (FROG-7 SERIES)**

<b>ROCKET 9M#</b>	<b>WARHEAD 9N#</b>	<b>DESCRIPTION</b>
9M21B	NA	NUCLEAR
9M21D	NA	CARRIER, LEAFLETS
9M21E	9N18E	CARRIER, 42 9N22 HE/FRAG SUBS
9M21F	9N18F	HE/FRAG, 450KG WARHEAD
9M21G	NA	CHEMICAL

**GUIDED MISSILES**

<b>9M Number</b>	<b>DESCRIPTION</b>
9M14	AT-3 SAGGER
9M14M or P	AT-3 SAGGER W/IMPROVED W/HEAD
9M14P1	AT-3 SAGGER W/STANDOFF PROBE AND INERTIA FUZE
9M14-2	AT-3 SAGGER W/3.5KG HEAT W/HEAD
9M14-2M	AT-3 SAGGER TANDEM HEAT W/HEAD
9M17	AT-2 SWATTER
9M111, 9M111M	AT-4 SPIGOT
9M112	AT-8 SONGSTER OR COBRA
9M113, 9M113M	AT-5 SPANDREL
9M114	AT-6 SPIRAL
9M114M1 AND M2	AT-9 SPIRAL 2
9M115	AT-7 SAXHORN
9M117 AND 117M	AT-10 STABBER, 100mm HEAT, 117m HAS TANDEM W/HEAD
9M117M	AT-10 STABBER, AT-10 VARIANT FOR 115mm SMOOTHBORE T-62 GUN
9M119 AND 119M	AT-11 SNIPER, 125mm HEAT, 119M HAS TANDEM W/HEAD
9M120	AT-12 SWINGER, HE-FRAG EXPANDING ROD, THERMOBARIC, HEAT AND TANDEM HEAT W/HEADS AVAILABLE
9M120M	AT-16, 8 KG HEAT W/EAD WITH IMPACT AND PROX FUZES
9M131	AT-13, 130mm 4.6 KG TANDEM HEAT
9M131F	AT-13, 130mm 4.95KG THERMOBARIC
9M133	AT-14 KORNET, 152MM
9M133-1	AT-IX-14, 152mm HEAT
9M133F-1	AT-IX-14, 152mm THERMOBARIC
9M32	SA-7 GRAIL
9M36 or 9M36-1	SA-14 GREMLIN

**GUIDED MISSILES****9M Number****DESCRIPTION**

9M313 OR 9M313-1	SA-16 GIMLET
9M39	SA-18 GARGOYLE
9M31	SA-9 STRELA or GASKIN
9M31M	SA-9B STRELA-1M or GASKIN
9M33	SA-8 GECKO
9M333	SA-13 GOPHER
9M82	SA-12B GIANT
9M83	SA-12 GLADIATOR
9M38M1	SA-11 GADFLY
9M330	SA-15 GAUNTLET
9M317	SA-17 GRIZZLY
9M311	SA-19 GRISON
9M12	SS-N-3A SHADDOCK
9M714	SS-23 SPIDER
9M721	SS-21 MOD 3 SCARAB
9M79M	SS-21 MOD 2 SCARAB

# SECTION B

## GRENADES

- ◆ HAND GRENADES
- ◆ PROJECTED GRENADE
- ◆ RIFLE GRENADES
- ◆ SMOKE GRENADES
- ◆ RIOT CONTROL SMOKE AND INCENDIARY GRENADES
- ◆ 30mm & 40mm GRENADES

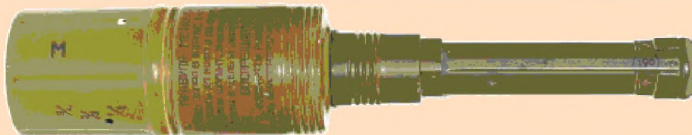

## HAND GRENADES

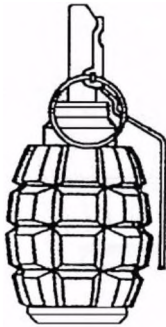

**Russian Grenade, Hand, Frag, F-1.**  
Len: 117mm, Dia: 55mm



**Russian Grenade, Hand, RG-42.**  
Len: 121mm, Dia: 54mm

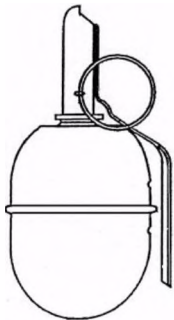

**Russian Grenade, Hand, Frag, RDG-5.**  
Len: 114mm, Dia: 57mm

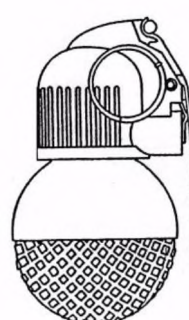

**Russian Grenade, Hand, Frag, RGO.**  
Len: 114mm, Dia: 61mm

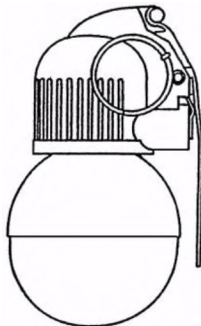

**Russian Grenade, Hand, Frag, RGN.**  
Len: 113mm, Dia: 61mm



**Russian Grenade, Hand, Frag, No 36 Mk1.**  
Len: 100mm, Dia: 61mm



**Grenade, Hand, Fragmentation, Delay, M33**  
Overall Length: 90.00mm (3.54in)  
Diameter: 64.00mm (2.52in)  
Filler: Comp B NEW: 185.00g (6.53oz)  
Fuze: Striker-release, M213



**Former Yugo Grenade, Hand, HE, M75**  
Length w/o Fuze: 62.74mm (2.47in)  
Diameter: 56.00mm (2.20in) Overall  
Weight: 290.00g (10.23oz)  
Filler: PETN NEW: 43.20g (1.52oz)  
Fuze: Striker-release

## HAND GRENADES



**Iraqi Grenade, Hand, HE, Model Unknown**  
Fuze: Striker-release. Copy of the UZRGM.



**Egyptian Grenade, Hand, HE, No 2**  
Overall Height: 84.00mm (3.31in)  
Diameter: 53.00mm (2.09in)  
Filler: TNT NEW: 42.00g (1.48oz) Fuze: Impact



**British Grenade, Hand, HE, No 36**  
Overall Length: 102.00mm (4.02in)  
Diameter: 61.00mm (2.40in)  
Filler: TNT NEW: 60.00g (2.12oz)  
Fuze: Striker-release



**Egyptian Grenade, Hand, HE, No1**  
Overall Length: 105.00mm (4.13in)  
Diameter: 59.00mm (2.32in)  
Filler: Comp B NEW: 65.00g (2.29oz) Fuze:  
Striker-release



**Czech Grenade, Hand, HE, RG4**  
Overall Length: 84.00mm (3.31in)  
Diameter: 53.00mm (2.09in)  
Filler: TNT NEW: 0.11kg (0.24lbs)  
Fuze: Impact



**Russian Grenade, Hand, HE, RGD5**  
Overall Length: 117.00mm (4.61in)  
Diameter: 58.00mm (2.28in) Overall  
Weight: 320.00g (11.29oz)  
Filler: 111g TNT NEW: 111.00g (3.92oz)  
Fuze: UZRG, UZRGM, UZRGM-2 or DVM striker  
release

# HAND GRENADES



**Russian Grenade, Hand, HE, RG42**  
Overall Length: 121.00mm (4.76in)  
Diameter: 54.00mm (2.13in)  
Filler: TNT NEW: 120.00g (4.23oz)  
Fuze: Striker-release, UZRG & UZRGM



**Chinese Grenade, Hand, HE, Type 82-2**  
Overall Length: 85.00mm (3.35in)  
Diameter: 48.00mm (1.89in)  
Filler: TNT NEW: 62.00g (2.19oz)



**Chinese Grenade, Hand, HE, Type 86P**  
Overall Length: 90.00mm (3.54in)  
Diameter: 52.00mm (2.05in)  
Filler: PETN Fuze: Striker-release



**British Grenade, Hand, Smoke, RP, L84A1**  
Overall Length: 129.00mm (5.08in)  
Diameter: 60.00mm (2.36in)  
Filler: RP Fuze: Striker-release



**British Grenade, Hand, Smoke (Green), Model Unknown**  
Overall Length: 147.00mm (5.79in)  
Diameter: 60.00mm (2.36in)  
Filler: Smoke - Green Fuze: Striker-release

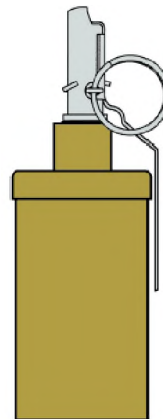

**Iraqi Grenade, Hand, Smoke, Model Unknown**  
Filler: Burning smoke  
Fuze: Striker-release. Copy of the UZRGM.

# HAND GRENADES

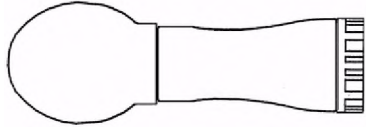

**Chinese Grenade, Hand, Stick, HE, Type 77-1**  
Len: 172mm Dia: 48mm

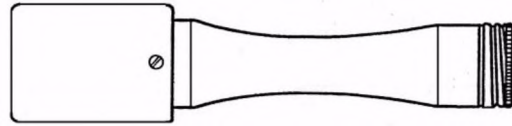

**Chinese Grenade, Hand, Stick, HE, Model Unknown**

Len: 172mm (est) Dia: 48mm (est)

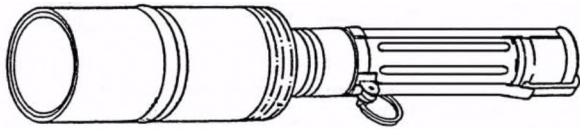

**Russian Grenade, Hand, RKG-3M**  
Len: 388mm Dia: 76mm

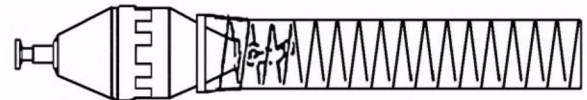

**Egyptian Grenade, Hand, Heat, Type 1 & 2 (HASAM)**

Len: 405mm Dia: 61mm

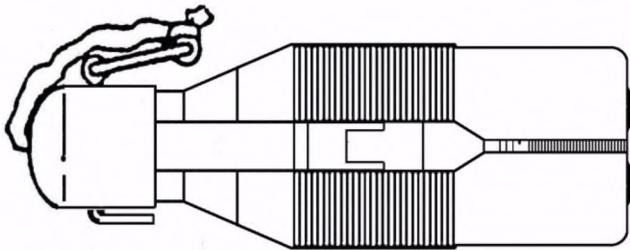

**Egyptian Grenade, Hand, Heat, Type 1 & 2 (HASAM)**

Len: 405mm Dia: 61mm

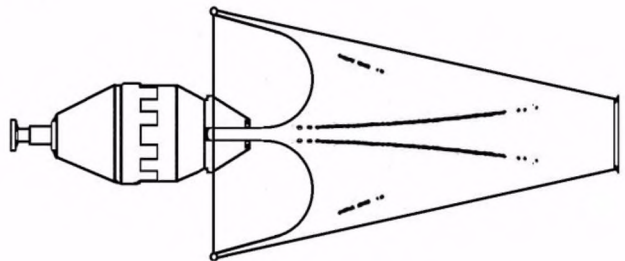

**Egyptian Grenade, Hand, Heat, Type 1 & 2 (HASAM)**

Len: 405mm Dia: 61mm

## PROJECTED GRENADE



### Bulgarian Grenade, Projected, HE, OG7

Overall Length: 569.00mm (22.40in)  
 Diameter: 40.00mm (1.57in)  
 Filler: RDX NEW: 210.00g (7.41oz)  
 Fuze: PD, O4M

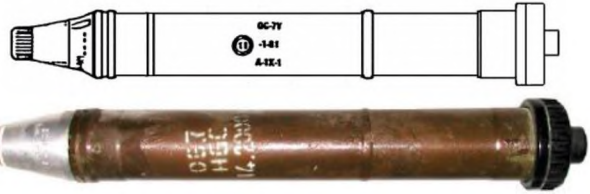

### Iraqi Grenade, Projected, HE, OG7

Overall Length: 272.00mm (10.71in)  
 Diameter: 40.00mm (1.57in)  
 Filler: RDX NEW: 210.00g (7.41oz)  
 Fuze: PD, M6



### German Grenade, Projected, HEAT, ARMBRUST

Overall Length: 405.00mm (15.94in)  
 Diameter: 67.00mm (2.64in)  
 Cartridge Weight: 6.70kg (14.74lbs)  
 projectile: 1.00kg (2.20lbs)  
 RDX: 169.00g (5.96oz)  
 Fuze: Setback armed, impact-fired, base  
 detonating piezoelectric crystal



### Russian Grenade, Projected, HEAT, PG2

Overall Length: 502.00mm (19.76in)  
 Diameter: 80.00mm (3.15in)  
 Overall Weight: 1.80kg (3.96lbs)  
 Filler: RDX & TNT NEW: 0.57kg (1.25lbs)  
 Fuze: BD, DK2 / BDS, DK4



### British Grenade, Projected, HEAT, PIAT

Overall Length: 408.00mm (16.06in)  
 Diameter: 89.00mm (3.50in)  
 Filler: TNT Fuze: PIBD



### Iranian Grenade, 40mm, Projected, HE, SAEGHEH

Overall Length: 328.00mm (12.91in) Overall  
 Weight: 1.40kg (3.08lbs)  
 Filler: TNT NEW: 880.80g (31.07oz) Fuze: PD,  
 MP1 or M6



### Chinese Grenade, Projected, HEAT, Type 56 Modified

Overall Length: 514.00mm (20.24in)  
 Diameter: 80.00mm (3.15in)  
 Filler: TNT NEW: 570.00g (20.11oz)  
 Fuze: BD, Type 4



### Chinese Grenade, Projected, HEAT, 80mm, Type 56 Variant 2

Overall Length: 514.00mm (20.24in)  
 Diameter: 80.00mm (3.15in)  
 Filler: RDX & TNT NEW: 570.00g (20.11oz)  
 Fuze: BD, Type 4

## PROJECTED GRENADE



**Belgian Grenade, Rifle, HE, RFL55**  
 Overall Length: 301.00mm (11.85in)  
 Diameter: 55.00mm (2.17in)  
 NEW: 158.00g (5.57oz)  
 Fuze: PD Notes: Fin-stabilized.



**Iranian Grenade, Rifle, HE, SA100**  
 Overall Length: 232.00mm (9.13in)  
 Diameter: 57.00mm (2.24in)  
 Filler: PETN NEW: 44.00g (1.55oz)  
 Fuze: BD, Impact



**Iranian Grenade, Rifle, HEAT, Model Unknown**

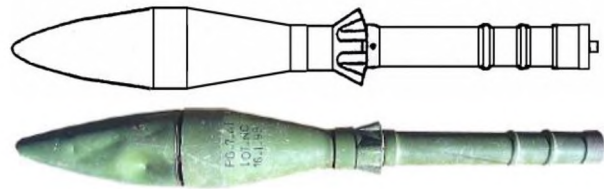

**Iranian Grenade, 85mm, HEAT, Nadar**  
 Len: 620mm (Est)

## RIOT CONTROL, SMOKE, INCENDIARY GRENADES

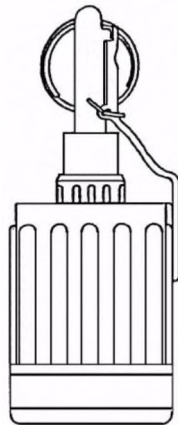

**Russian Grenade, Hand, Riot Control, Model Unknown**  
 Len: 150mm Dia: 59mm

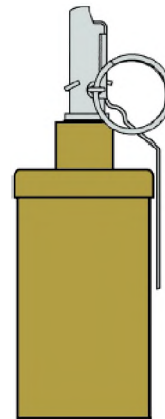

**Iraqi Grenade, Hand, Smoke, Model Unknown,**  
 Filler: Burning smoke  
 Fuze: Striker-release. Copy of the UZRGM.



**Iraqi Grenade, Projected, Smoke, Model Unknown**  
 Overall Length: 272.00mm (10.71in) Diameter:  
 84.00mm (3.31in)  
 Filler: Smoke composition, Fuze: Fixed-time



**Russian Grenade, Projected, Smoke, 3D6**  
 Overall Length: 218.00mm (8.58in) Diameter:  
 80.00mm (3.15in) Filler: Smoke composition  
 Fuze: Fixed-time

## RIFLE GRENADES

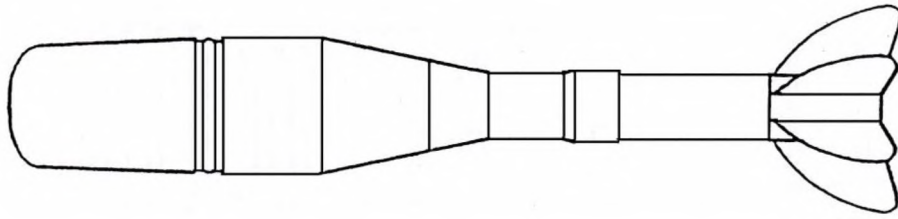

**Yugoslav Grenade, Rifle, HEAT, Model M60**  
Len: 390mm Dia: 60mm  
Fuze: BD DI M60



**Former Yugoslav Grenade, Rifle, HE, M60**  
Overall Length: 307.00mm (12.09in)  
Diameter: 30.00mm (1.18in)  
Filler: RDX/Aluminum NEW: 0.06kg (0.13lbs)  
Fuze: PD, UTM70P1



**Former Yugoslav Grenade, Rifle, Practice, M60 Practice**  
Overall Length: 381.00mm (15.00in)  
Diameter: 62.00mm (2.44in) Overall Weight: 614.00g (21.66oz)  
Filler: NONE Notes: No explosive components

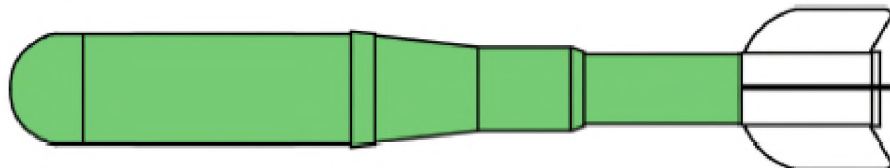

**Former Yugoslav Grenade, Rifle, Illumination, M62**  
Overall Length: 330.00mm (12.99in)  
Diameter: 40.00mm (1.57in)  
Filler: Illumination composition NEW: 0.10kg (0.22lbs) Fuze: BD / Time

## RIFLE GRENADES

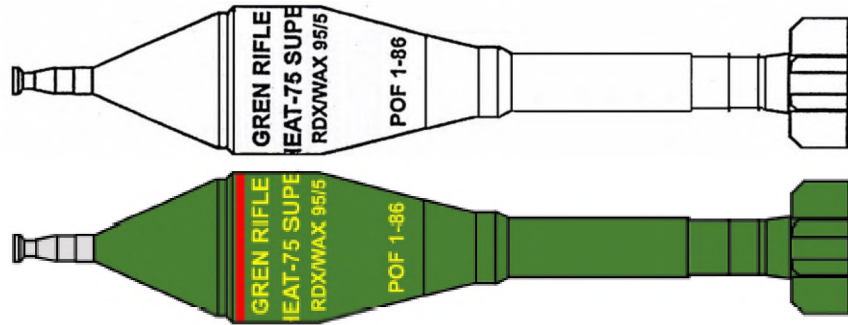

### Pakistani Grenade, Rifle, HEAT, P2 Mk1

Overall Length: 425.00mm (16.73in)

Diameter: 75.00mm (2.95in) 60 Series: 60E-55-2-1 Filler: RDX Fuze: PIBD

## 30mm & 40mm GRENADES



### Russian Grenade, 30mm, HE, VOG-17M

Len: 132mm Dia: 30mm Fuze: PD, VMG-M

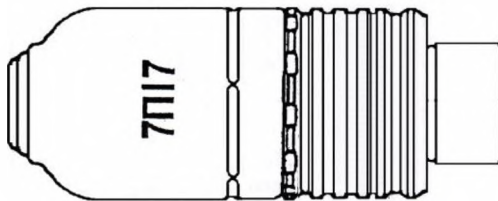

### Russian Grenade, Projected, 40mm, OG-25 or 7P17

Overall Length: 101.00mm (3.98in)

Diameter: 40.00mm (1.57in)

Filler: RDX NEW: 47.00g (1.66oz)

Fuze: VMGK

Notes: Can also be marked 7P17

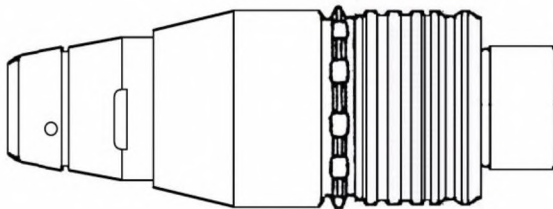

### Russian Grenade, 40mm, HE, VOG-25M/VOG 25P

Overall Length: 120.00mm (4.72in)

Diameter: 40.00mm (1.57in)

Filler: TNT NEW: 38.00kg (83.60lbs) Fuze: VMG-K, PDSD

Notes: Munition bounds into air after impact.

# SECTION C

## INFANTRY WEAPONS

- RECOILLESS RIFLE

- ROCKETS

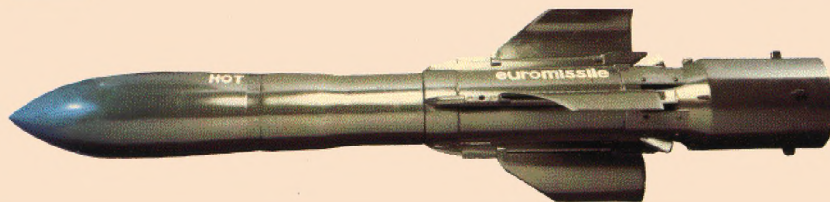
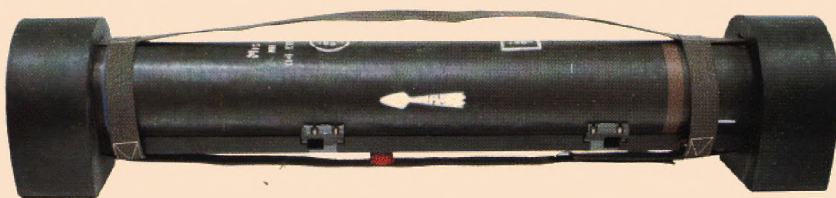

## RECOILLESS RIFLE AMMUNITION

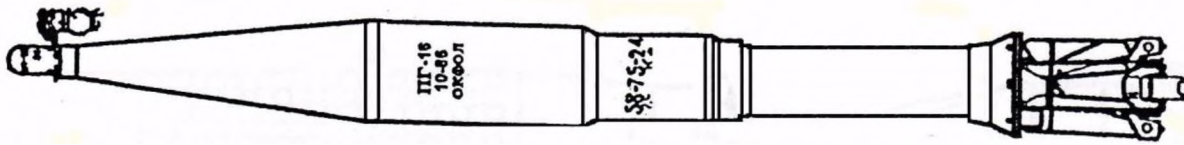

Russian Projectile, 58.3mm, HEAT, PG-16  
Len: 638mm



Russian Projectile, 73mm, HEAT, PG-9, PG-9S  
Len: 773mm

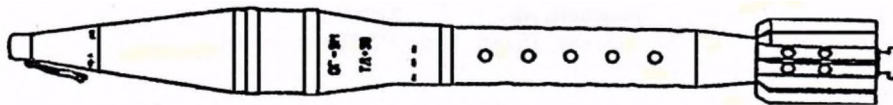

Russian Projectile, 73mm, HE, OG9  
Overall Length: 729.00mm (28.70in)  
Diameter: 73.00mm (2.87in)  
Filler: TNT NEW: 0.70kg (1.54lbs) Fuze: PD, GO2



Romanian Projectile, 73mm, HE, 346-E/OG-9  
Len: 457mm Fuze: PD, 346-E

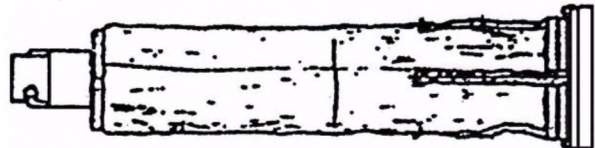

Cartridge Case for 73mm, Recoilless Rifle,  
SPG-6  
Len: 364mm

## 75mm RECOILLESS RIFLE AMMUNITION

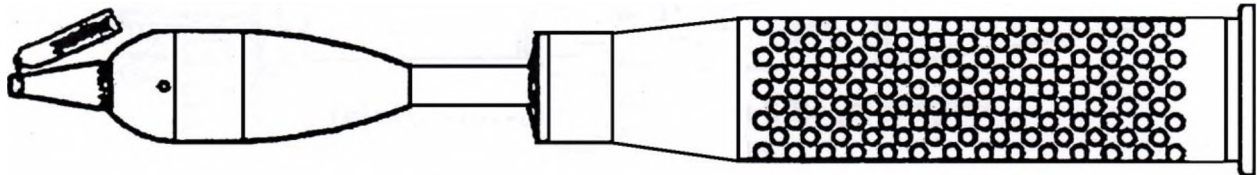

Chinese Projectile, HEAT, Type Unknown  
Len: 409mm Dia: 75mm Fuze: PIPB, Type 2

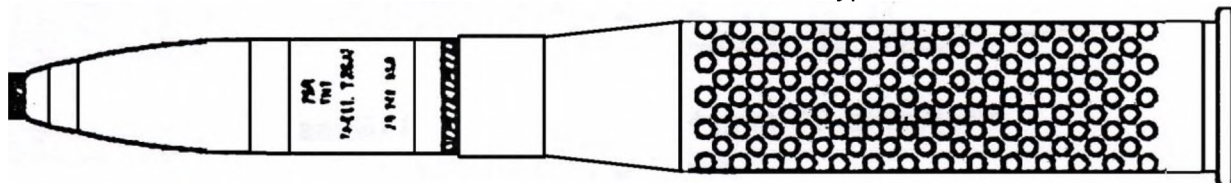

Chinese Projectile, HE, 26.12  
Len: 350mm Dia: 75mm Fuze: PD, Type 3 Special

# AMMUNITION FOR 82mm RECOILLESS RIFLE TYPE 65 (China)

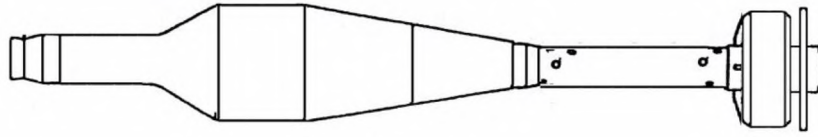

**Chinese Projectile, 82mm, HEAT, Type 65**  
 Len: 583mm Fuze: BD, Type 4

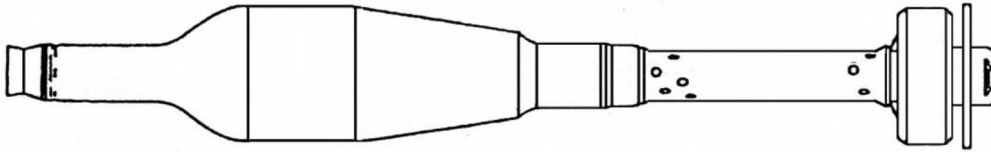

**Chinese Projectile, 82mm, HEAT, Type 65 Modified**  
 Overall Length: 578.00mm (22.76in)  
 Diameter: 82.00mm (3.23in) Overall Weight: 3.40kg (7.48lbs)  
 Filler: RDX and PETN Net Explosive Weight: 428.00g (15.10oz)  
 Fuze: BD, Type 4 Notes: Recoilless rifle

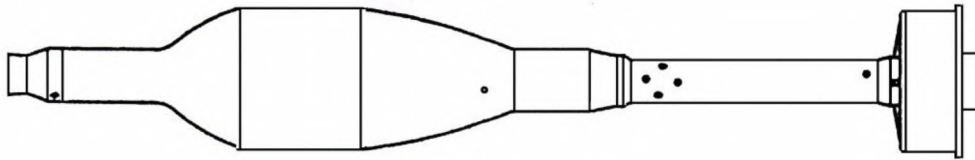

**Chinese Projectile, 82mm, HEAT, Type 65 Modified**  
 Overall Length: 584.00mm (22.99in)  
 Diameter: 82.00mm (3.23in)  
 Filler: RDX NEW: 595.00g (20.99oz)

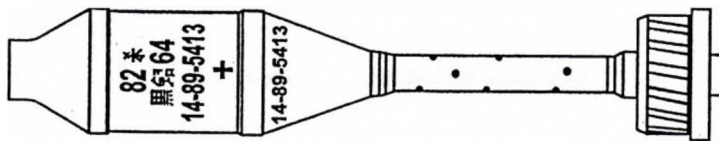

**Chinese Projectile, 82mm, HE, Model Unknown**  
 Len: Unknown Comment: Shown w/o Fuze

## AMMUNITION FOR 82mm RECOILLESS RIFLE B10 (Russia)



### Russian Projectile, 82mm, HEAT, BK881M

Overall Length: 608.00mm (23.94in)  
 Diameter: 82.00mm (3.23in) Overall Weight: 4.75kg (10.45lbs)  
 Filler: RDX NEW: 550.00g (19.40oz) Propellant Weight: 877.00g (30.94oz)  
 Fuze: PIBD, GK2M

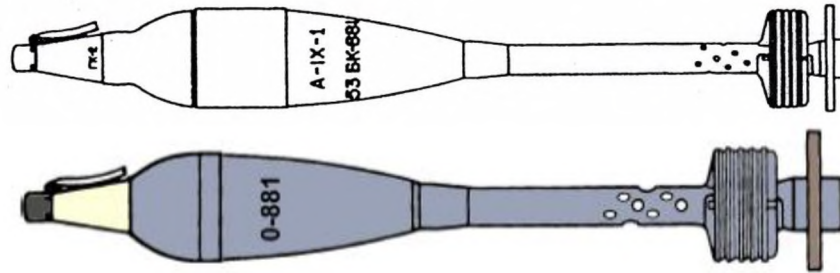

### Russian Projectile, 82mm, HE, O881

Overall Length: 534.00mm (21.02in)  
 Overall Height: 82.00mm (3.23in)  
 Filler: TNT & DNN NEW: 470.00g (16.58oz) Fuze: PD, GK2

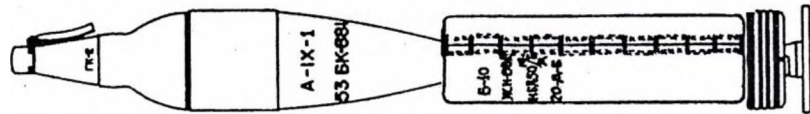

### Russian Projectile, 82mm, HE, O881A

Len: 608mm Fuze: PD, GK-2

## AMMUNITION FOR THE RPG-7 LAUNCHER



### Russian Grenade, 70mm, HEAT, PG-7M / PG-7S

Len: 679mm Fuze: PIBD, VP-7

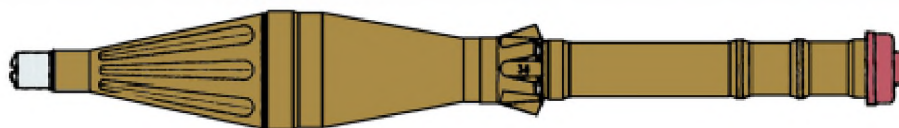

### Russian Grenade, HEAT, PG-7L (also PG-7G)

Len: 646mm Fuze: PIBD, VP-7

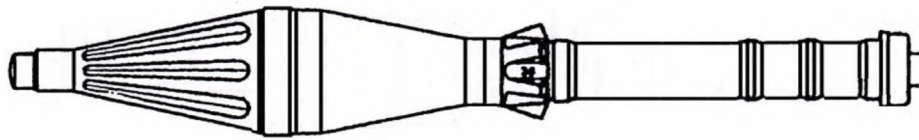

Chinese Grenade, 85mm, HEAT, Type 69  
Len: 646mm

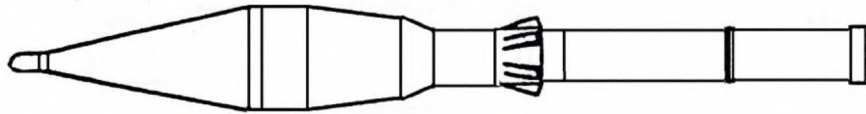
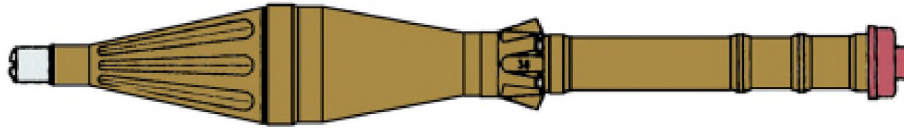

Russian Grenade, 93mm, HEAT, PG-7L  
Len: 790mm Fuze: PIBD, VP-22

## RUSSIAN ROCKET LAUNCHER RPG 22 WITH ROCKET, 72.5mm, HEAT, PG 22

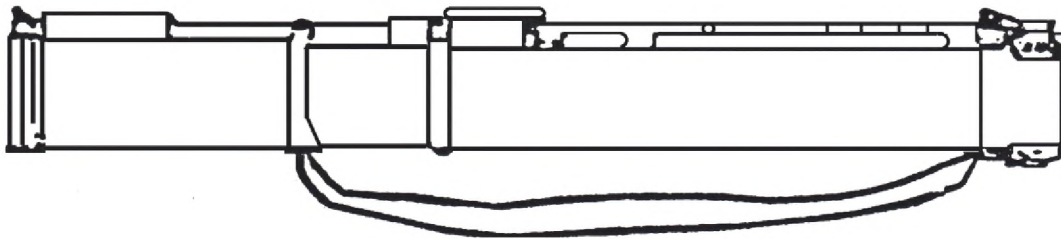

Rocket Launcher not Extended

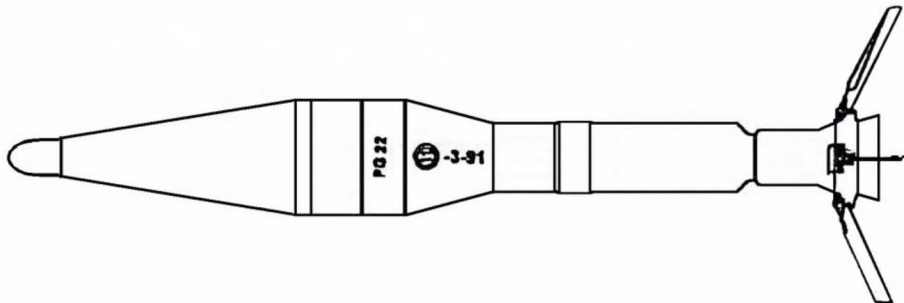

Rocket, 72.5mm, HEAT, PG 22

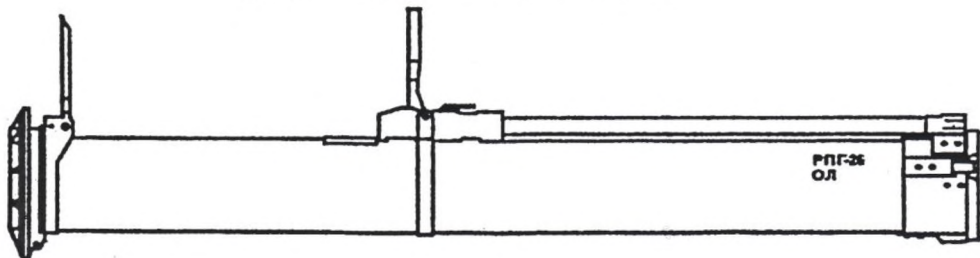

Russian Rocket Launcher RPG 26 with Rocket, 72.5mm, HEAT, PG 26

## AMMUNITION

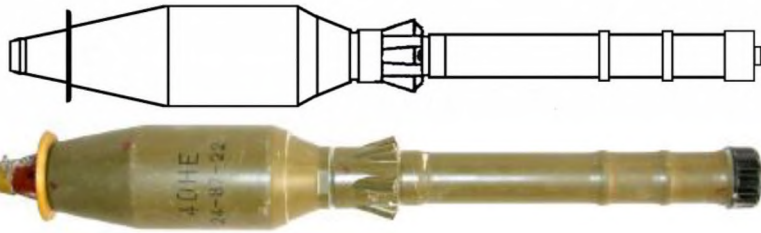

### Chinese Grenade, 75mm, Bounding, Type 69

Len w/Eject Motor: 805mm Fuze: PD, MJ-7



### Russian Projectile, 76mm, HEAT, BK354M

Overall Length: 567.00mm (22.32in)

Diameter: 76.00mm (2.99in)

Filler: RDX NEW: 0.80kg (1.76lbs) Fuze: PIBD, GPV2

## AMMUNITION FOR THE RPG-2 GRENADE LAUNCHER (Russia)

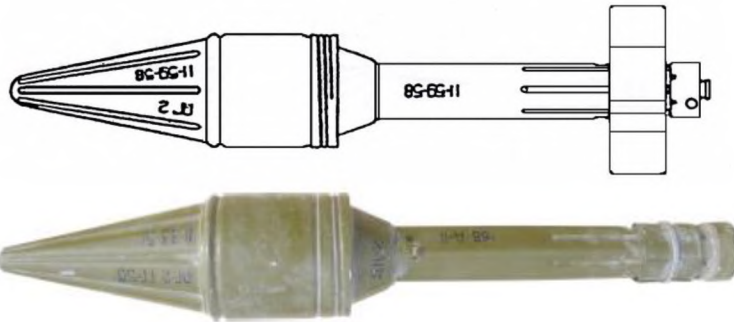

### Russian Grenade, Projected, HEAT, PG2

Overall Length: 502.00mm (19.76in)

Diameter: 80.00mm (3.15in)

Overall Weight: 1.80kg (3.96lbs)

Filler: RDX & TNT NEW: 0.57kg (1.25lbs) Fuze: BD, DK2 / BBSD, DK4

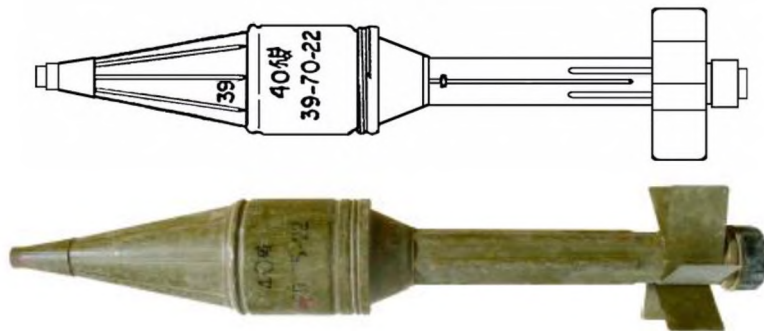

### Chinese Grenade, Projected, HEAT, Type 56 Modified

Overall Length: 514.00mm (20.24in)

Diameter: 80.00mm (3.15in)

Filler: TNT NEW: 570.00g (20.11oz) Fuze: BD, Type 4

# AMMUNITION FOR THE RPO SERIES of PROJECTED MUNITIONS (Russia)

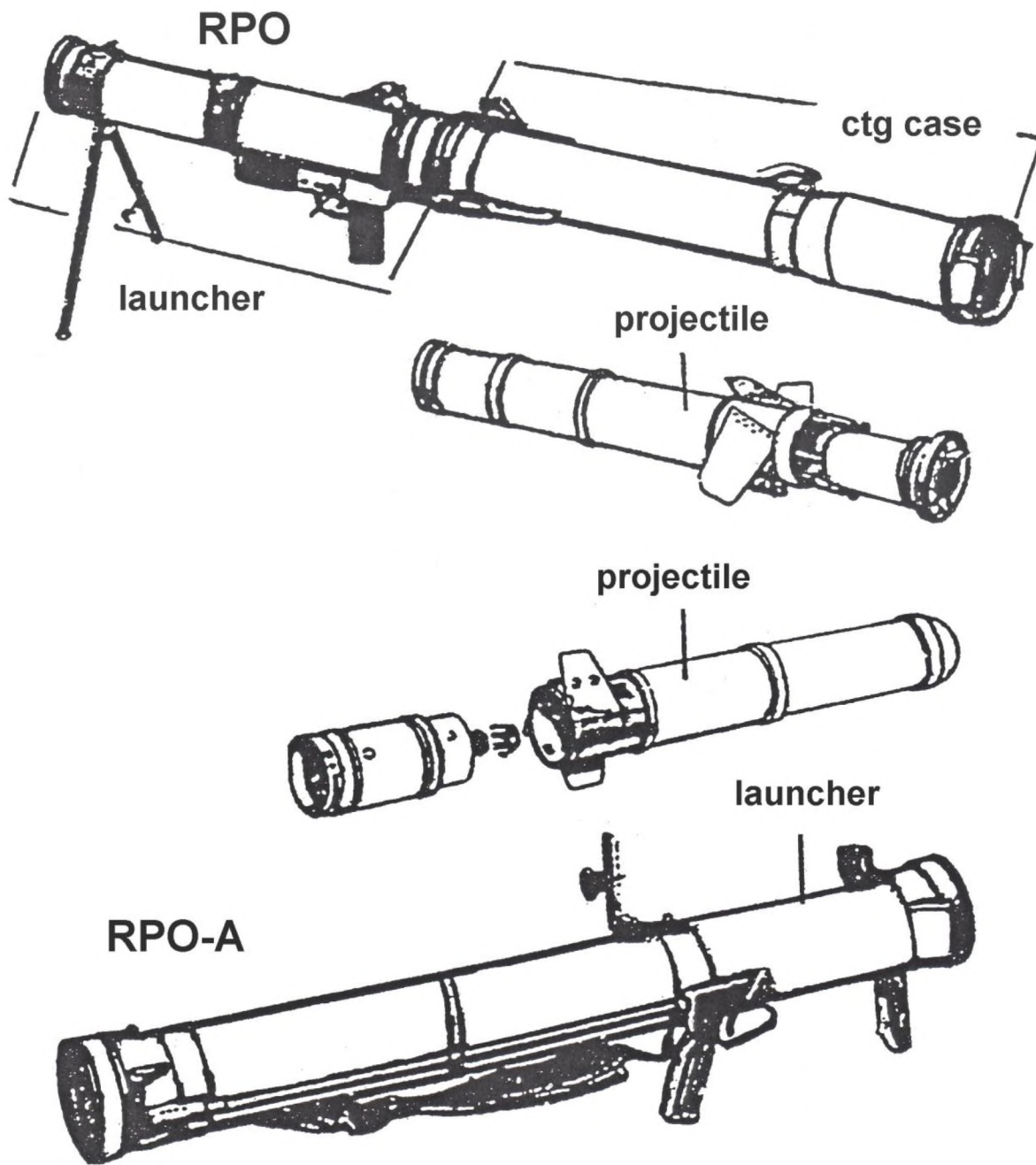

# SECTION D

## MINES

- ◆ ANTI-TANK MINES
- ◆ ANTI-PERSONNEL MINES
- ◆ SCATTERABLE MINES
- ◆ CONTROLLED DEVICES
- ◆ TRIP FLARES



## ANTI-TANK MINES



**Czech Mine, Anti-tank, PTMIBAIII**  
 Overall Height: 101.00mm (3.98in)  
 Diameter: 330.00mm (12.99in)  
 Filler: TNT NEW: 7.20kg (15.84lbs)  
 Fuze: Pressure, RO2 & RO7I



**U.S. Mine, Anti-tank, M21**  
 Overall Height: 314.00mm (12.36in)  
 Diameter: 229.00mm (9.02in)  
 Filler: Comp B or comp  
 H-6 NEW: 4.80kg (10.56lbs)  
 Fuze: Tilt Notes: Shown without fuze

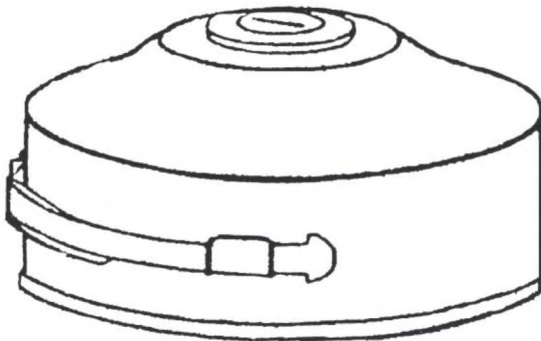

**British Mine, AT, Mk 7**  
 Dia: 325mm, Height: 130mm,  
 Fuze: Pressure

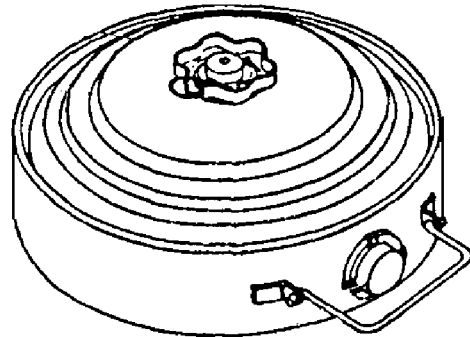

**Russian Mine, AT, TM 46 / TMN 46**  
 Dia: 305mm Height: 108mm,  
 Fuze: Pressure – MVM, MV-5, Tilt Rod – MVSh-46

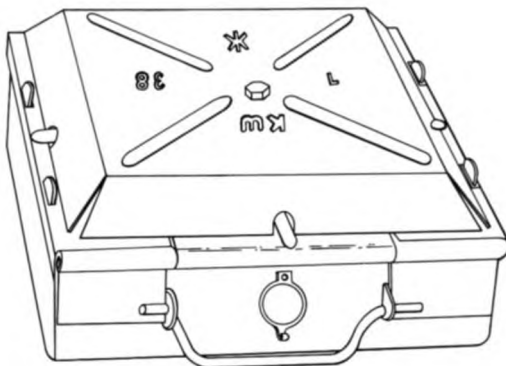

**Russian Mine, AT, TM 38**  
 Width: 220mm Height: 80mm,  
 Fuze: Pressure - MUV



**Belgian Mine, Anti-tank, PRBM3**  
 Length: 227.00mm (8.94in)  
 Width: 227.00mm (8.94in)  
 Height: 120.00mm (4.72in)  
 Filler: Triatene NEW: 6.00kg (13.20lbs)  
 Fuze: Pressure

## ANTI-TANK MINES



**Italian Mine, Anti-tank, SB81**  
 Height: 90.00mm (3.54in)  
 Diameter: 230.00mm (9.06in)  
 Filler: TNT / RDX / HMX (84/15/1) NEW: 2.20kg  
 (4.84lbs)  
 Fuze: Pressure

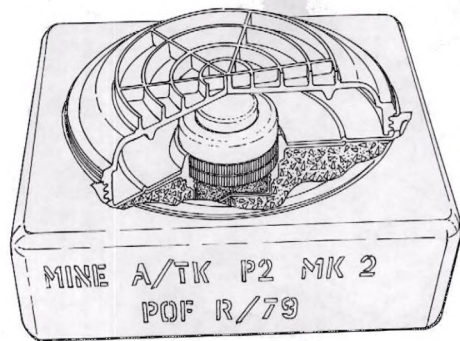

**Pakistan Mine, AT, P2 Mk2, AP Initiated**  
 Len: 262mm Height: 120mm,  
 Fuze: Pressure – P4 Mk1



**U.S. Mine, Anti-tank, M19**  
 Length: 332.00mm (13.07in) Width: 332.00mm  
 (13.07in) Height: 94.00mm (3.70in)  
 Filler: Comp B NEW: 9.53kg (20.97lbs)  
 Fuze: Pressure, M606



**Italian Mine, Anti-tank, VS2.2**  
 Height: 115.00in (2,921.01mm)  
 Diameter: 230.00mm (9.06in)  
 Filler: Comp B NEW: 2.20kg (4.84lbs)  
 Fuze: VS-N Pressure, VS-N-TLC Pressure,  
 Electronic Self-Neutralize, VS-N-EL2 Pressure,  
 Electronic Anti-Disturbance, Self-Destruct  
 Fuzes.

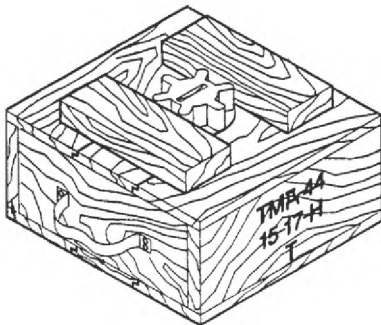

**Russian Mine, AT, TMD 44**  
 Len: 320mm Width: 290mm Height: 145mm,  
 Fuze: Pressure

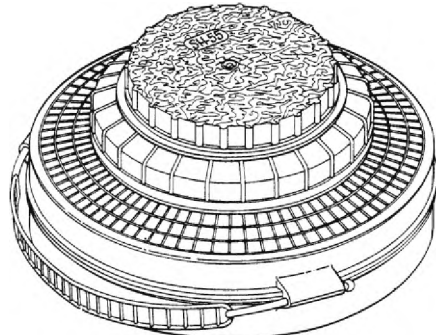

**Italian Mine, AT, SH55**  
 Dia: 270mm Height: 137mm,  
 Fuze: Anti-disturbance – VS – N/AR-AN,  
 Pressure: VS-N, FD-64, SH-160

## ANTI-TANK MINES



**Russian Mine, Anti-tank, TM57**  
 Height: 119.00mm (4.69in)  
 Diameter: 312.00mm (12.28in)  
 Overall Weight: 9.80kg (21.56lbs)  
 Filler: TNT or RDX TNT &  
 Aluminum NEW: 7.00kg (15.40lbs)  
 Fuze: Pressure, MVZ57 / Tilt, MVSh



**Russian Mine, Anti-tank, TM62M**  
 Overall Height: 128.00mm (5.04in)  
 Diameter: 320.00mm (12.60in)  
 Filler: TNT NEW: 7.50kg (16.50lbs)  
 Fuze: MVCh-62 Pressure, MVN-72  
 and MVN-80 Magnetic Influence Fuzes  
 Notes: Training Mine Shown



**Italian Mine, Anti-tank, TC24**  
 Height: 108.00mm (4.25in)  
 Diameter: 204.00mm (8.03in)  
 Overall Weight: 3.50kg (7.70lbs)  
 Filler: RDX/TNT NEW: 2.40kg (5.28lbs)  
 Fuze: Pressure

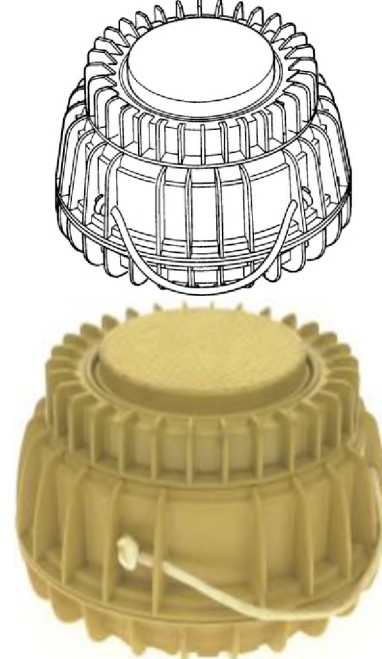

**Italian Mine, Anti-tank, TC6**  
 Overall Height: 179.00mm (7.05in)  
 Max Diameter: 273.00mm (10.75in)  
 Filler: RDX & TNT NEW: 13.50lbs (6.14kg)  
 Fuze: Pressure

## ANTI-TANK MINES

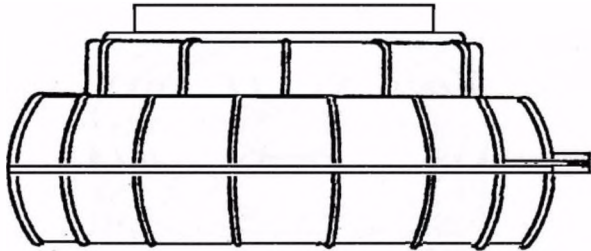

### Italian Mine, AT, VS 3.6

Dia: 270mm Height:145mm,  
Fuze: Pressure / Electronic / Anti-disturbance /  
Remote Control

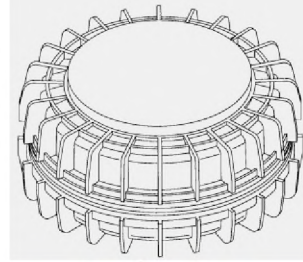

### Italian Mine, Anti-tank, VS1.6

Overall Height: 92.00mm (3.62in)  
Diameter: 222.00mm (8.74in)  
Filler: Comp B NEW: 1.85kg (4.07lbs)  
Fuze: Pressure Notes: There is an exact replica  
of this mine manufactured by Singapore. Mine  
can also be found with tan color.

## ANTI-PERSONNEL MINES

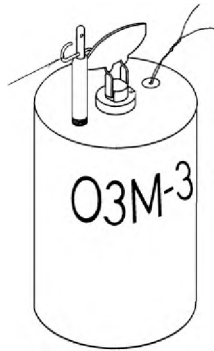

**Russian Mine, Bounding, APERS, OZM-3**  
 Dia: 75mm Height:120mm,  
 Fuze: Pull – MUV Series, RO-1 / Pressure – RO-8 Command Initiation



**Russian Mine, Antipersonnel, Bounding, OZM4**  
 Height: 140.00mm (5.51in)  
 Diameter: 90.00mm (3.54in)  
 Overall Weight: 5.00kg (11.00lbs)  
 TNT NEW: 170.00g (6.00oz) Fuze: Pull– MUV Series



**Russian Mine, Bounding, APERS, OZM-72**  
 Dia: 107mm Height:171mm,  
 Fuze: Pull – MUV Series, MN, Minefield Control Systems – VP Series

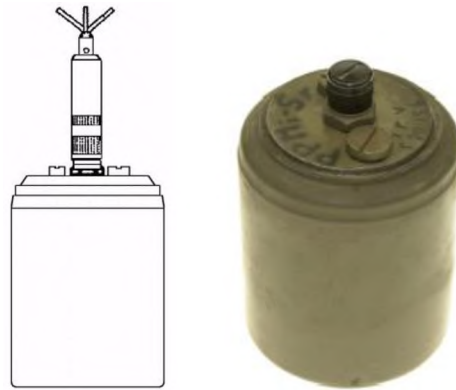

**Czech Mine, Antipersonnel, Bounding, PPMISR**  
 Overall Height: 152.00mm (5.98in)  
 Diameter: 101.00mm (3.98in)  
 Filler: TNT NEW: 362.00g (12.77oz) Fuze: Pull, RO1 & MUV Series / Pressure, RO8

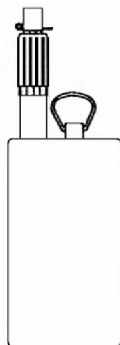

**Chinese Mine, Bounding, APERS, Type 69**  
 Dia: 60mm Heigh w/fuzet:168mm,  
 Fuze: Pull and/or Pressure – Type 69



**Pakistani Mine, Bounding, APERS, P7Mk1**  
 Dia: 97mm Height: 250mm,  
 Fuze: Duel Action Pressure/Tripwire

## ANTI-PERSONNEL MINES



**Italian Mine, Antipersonnel, Bounding, Valmara 69**

Overall Height: 130.00mm (5.12in)  
 Diameter: 130.00mm (5.12in)  
 Filler: Comp B NEW: 420.00g (14.82oz)  
 Fuze: Pressure, Tilt, Pull



**U.S. Mine, Antipersonnel, Bounding, M16A2**

Length w/o Fuze: 120.00mm (4.72in)  
 Length w/Fuze: 191.00mm (7.52in)  
 Diameter: 105.00mm (4.13in)  
 Filler: TNT NEW: 590.00g (20.81oz)  
 Fuze: Pull/Pressure



**Italian Mine, Antipersonnel, Bounding, P40**

Height: 200.00mm (7.87in)  
 Diameter: 90.00mm (3.54in)  
 Filler: TNT NEW: 480.00g (16.93oz) Fuze:  
 Pressure, Tilt

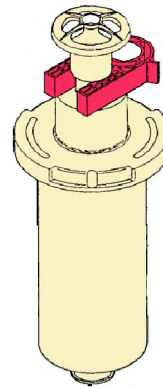

**Italian Mine, Antipersonnel, P25**

Overall Height: 180.00mm (7.09in)  
 Diameter: 75.00mm (2.95in) Filler: TNT or T4  
 NEW:  
 180.00g (6.35oz)  
 Fuze: Type 2 Pressure or type 1 Tripwire



**Russian Mine, Antipersonnel, Bounding, PSM-1**

Height Unfuzed: 110mm  
 Diameter: 75mm  
 Filler: Hexogen 170g  
 Fuze: MUV series, RO-8, MVN-2M, EVU series

## ANTI-PERSONNEL MINES



**Russian Mine, APERS, POMZ-2**  
 Dia: 60mm Height:130mm,  
 Fuze: Pull – MUV, MUV-2,  
 MUV-3, MUV-4



**Russian Mine, APERS, POMZ-2M**  
 Dia: 60mm Height:107mm,  
 Fuze: Pull – MUV, MUV-2,  
 MUV-3, MUV-4



**Belgian Mine, APERS, NR-413**  
 Dia: 46mm Height:114mm,  
 Fuze: Pull – NR-410



**Russian Mine, APERS, MON-50**  
 Width: 45mm Height:105mm,  
 Fuze: Pull – EDP-R, MN, MUV  
 Series Breakwire – MVZ-72  
 Minefield Control System – VP  
 Series Command Initiation



**Russian Mine, APERS, MON-90**  
 Width: 153mm Height:202mm,  
 Fuze: Pull – EDP-R, MN, MUV  
 Series Break wire – MVZ-72  
 Minefield Control System – VP  
 Series Command Initiation



**U.S. Mine, Antipersonnel, Directional, M18A1**  
 Overall Length: 216.00mm  
 (8.50in) Overall  
 Width: 36.00mm (1.42in)  
 Overall  
 Height: 83.00mm (3.27in)  
 Filler: C4 NEW: 680.00g  
 (23.99oz) Fuze:  
 Command-detonated

## ANTI-PERSONNEL MINES



**Russian Mine, Antipersonnel, Directional, MON100**

Overall Width: 80.00mm (3.15in)  
 Diameter: 9.92in (251.97mm)  
 Filler: TNT NEW: 4.90lbs (2.23kg) Fuze: Pull, MUV-Series, MVZ72



**Russian Mine, Antipersonnel, Directional, MON200**

Overall Width: 130.00mm (5.12in)  
 Diameter: 434.00mm (17.09in)  
 Filler: TNT NEW: 12.00kg (26.40lbs)  
 Fuze: MUV Series Mechanical or NM Electrical Initiators



**Russian Mine, APERS, PMN**

Overall Height: 56.00mm (2.20in)  
 Diameter: 112.00mm (4.41in) Filler: TNT NEW: 240.00g (8.47oz) Fuze: Pressure, Delay Arming

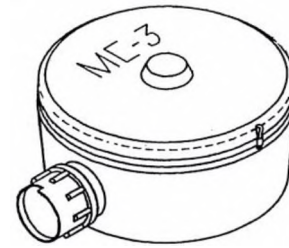

**Russian Mine, APERS, MS-3**

Dia: 112mm ,  
 Fuze: Pressure-release

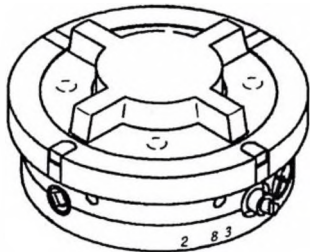

**Russian Mine, APERS, PMN-2**

Dia: 121mm Height: 52mm, Fuze: Pressure

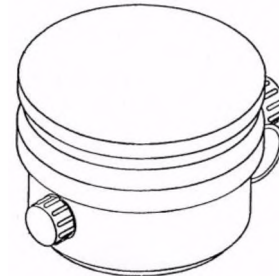

**Hungarian Mine, APERS, GYATA 64**

Dia: 106mm Height: 61mm, Fuze: Pressure

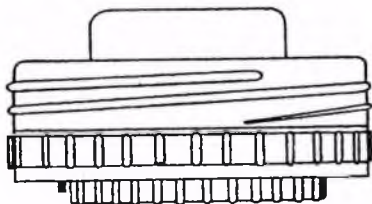

**Pakistani Mine, APERS, P4 Mk1**

Dia: 72mm Height: 45mm,  
 Fuze: Pressure. Could be used as a fuze to the PZMk2 and PZMk3 AT mine.



**Russian Mine, APERS, PMD-6**

Width: 89mm Height: 64mm,  
 Fuze: Pressure – MUV Series

## ANTI-PERSONNEL MINES

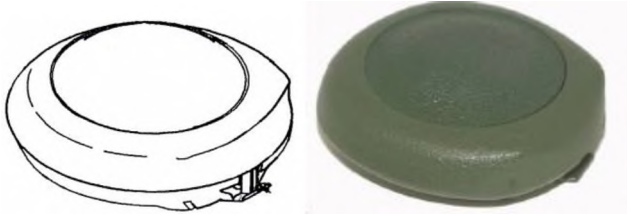

### Italian Mine, Antipersonnel, Blast, SB33

Height: 32.00mm (1.26in)

Diameter: 88.00mm (3.46in)

Overall Weight: 140.00g (4.94oz)

Filler: A-3 NEW: 35.00g (1.23oz) Fuze: Pressure

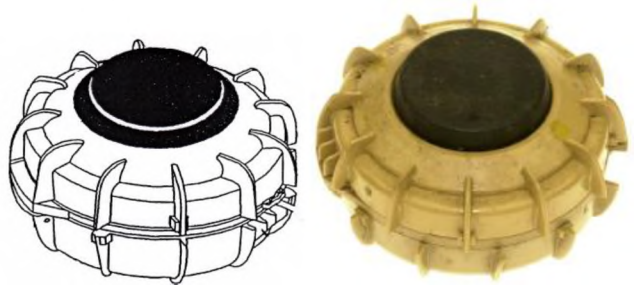

### Italian Mine, Antipersonnel, Blast, VS50

Height: 45.00mm (1.77in)

Diameter: 90.00mm (3.54in)

Filler: RDX NEW: 50.00g (1.76oz)

Fuze: Pressure



### Chinese Mine, APERS, Type 72A, 72B, 72C

Height: 38.00mm (1.50in)

Diameter: 78.00mm (3.07in) HIGH RISK

Filler: TNT NEW: 51.00g (1.80oz)

Fuze: Pressure Notes: The Type 72B and C are externally identical to the Type 72.

The 72B is electronic anti disturbance and self destruct.

The Type 72C is mechanical antilift.



### Chinese Mine, APERS, Blast, Type 72B

Height: 38.00mm (1.50in)

Diameter: 78.00mm (3.07in) HIGH RISK

Filler: TNT NEW: 51.00g (1.80oz)

Fuze: Electronic Anti-disturbance, Self-Destruct



### Belgian Mine, Antipersonnel, Blast, PRBM409, NR409, M409

Height: 28.00mm (1.10in)

Diameter: 82.00mm (3.23in)

Filler: TNT or Comp B NEW: 80.00g (2.82oz)

Fuze: Pressure



### Canadian Mine, Antipersonnel, Shaped-Charge, C3

Overall Length: 89.00mm (3.50in)

Max Diameter: 50.00mm (1.97in)

Filler: Tetryl NEW: 7.50g (0.26oz)

Fuze: Pressure

## ANTI-PERSONNEL MINES

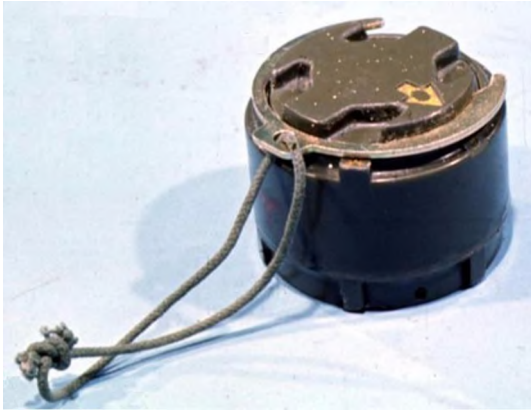

**U S Mine, Antipersonnel, Blast, M-14**

Height: 40mm  
Diameter: 56mm  
Filler: Tetryl 29.0 g  
Fuze: Pressure



**Italian Mine, Antipersonnel, Blast, VAR-40**

Height: 57mm  
Diameter: 78mm  
Filler: RDX or Composition B (RDX/TNT) 100g  
Fuze: Pressure

## SCATTERABLE MINES

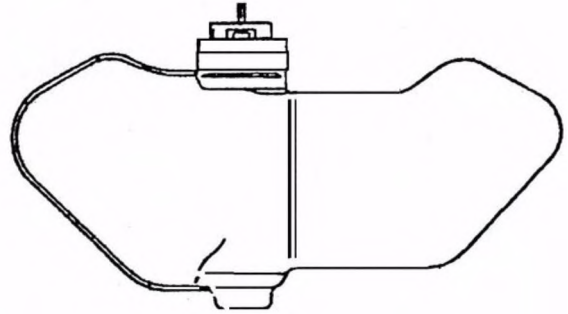
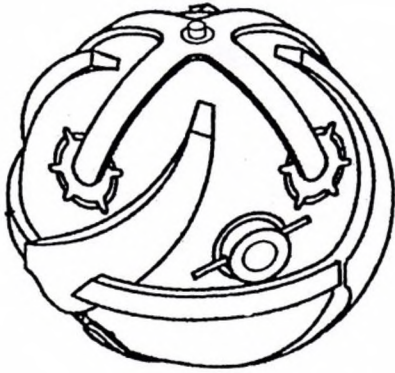

**Russian Mine, Scatterable, APERS, PM-1-S**

Dia: 80mm Fuze: Anti-disturbance.  
Note: Up to 8 tripwires deploy on landing

**Russian Mine, Scatterable, APERS, PFM-1-S**

Len: 120mm Height: 53mm  
Fuze: Pressure

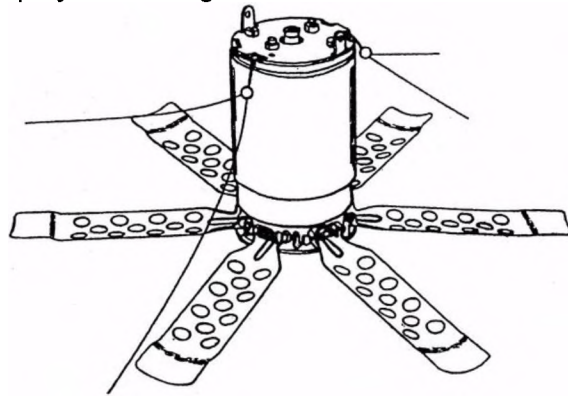

**Russian Mine, Scatterable, APERS, POM-2-S.**

Dia: 58mm Height: 119mm.  
Fuze: Pressure



**Former Yugoslavian Mine, Anti-tank, Scatterable, KPTM**

Overall Height: 117.00mm (4.61in)  
Diameter: 99.00mm (3.90in) Overall Weight:  
1.30kg (2.86lbs) Filler: TNT/RDX Net Explosive  
Weight: 196.00g (6.91oz) Fuze: Magnetic  
Influence Notes: Used with 262-mm rocket

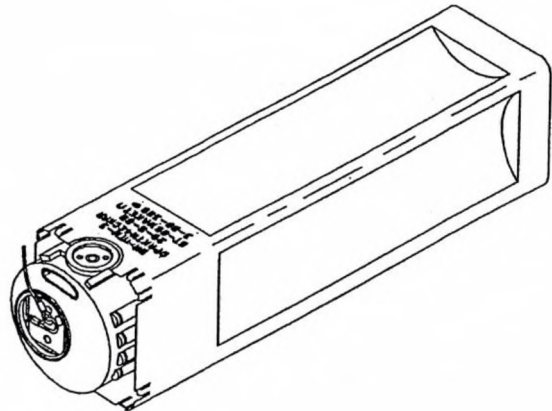

**Russian Mine, Scatterable, APERS, PTM-3**

Length: 330mm Height: 84mm.

## VKPM – 1 & 2 CONTROLLED MINE FIELD

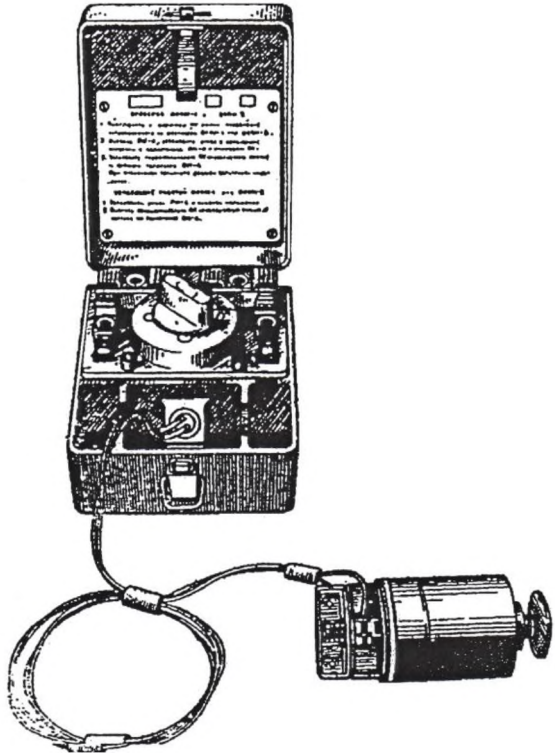

Mine Control Device

Blasting Machine / Initiator

A number of mines are wired into the control device. The desired mine is selected using the selected switch. The blasting machine is then used to initiate the selected mine. The VKPM-1 uses 4 OZM-72 mines. The VKPM-2 uses 4 MON-50 mines. SM signal flares are also issued with the system. Other mines may also be used with the system.

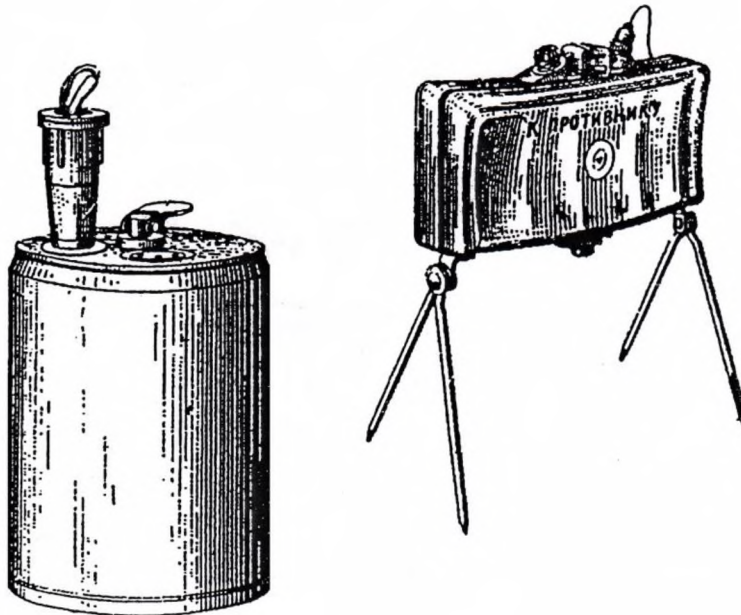

Associated Mines

**NVU – P**  
**(Also known as the VP-13)**

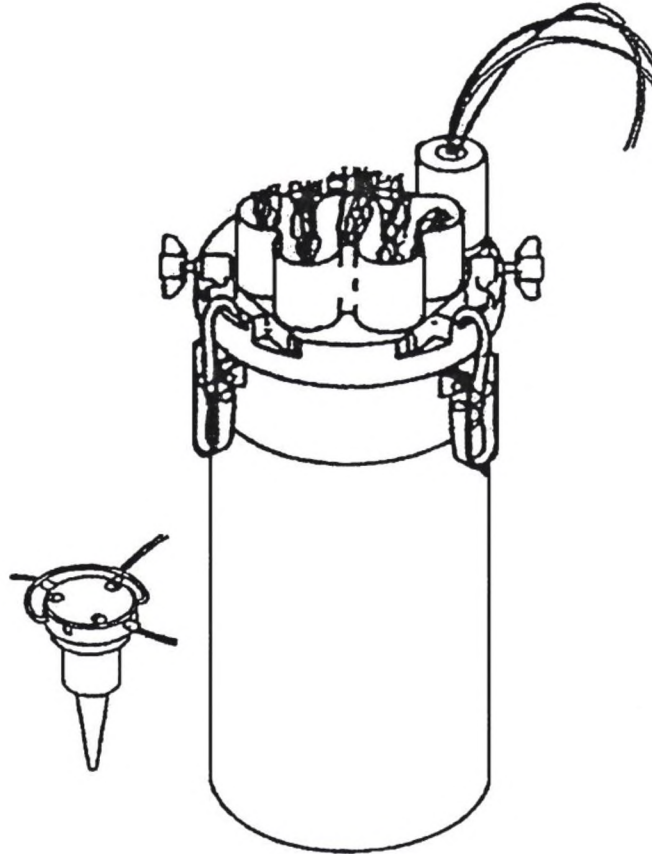

*Diameter of Body:* 125 mm

*Height:* 270 mm

*Weight:* 4 kg

*Explosive Weight:* None

*Case Material:* Sheet Metal

*Fuze:* Seismic Sensor Initiated

*Secondary Fuze Well:* 0

*Note:* Uses a geophone sensor to successively initiate up to five electronic mine fuzes.

*Usage:* For successive detonation of five anti-personnel mines, type OZM-72 or MON-50.

*Operational Life:* 3 months

*Power Supply:* 6 Batteries

*Features:* The system offers remote control on/off and mine activation options. Self-destruction occurs when the batteries are drained or when the fifth mine is detonated.

## TRIP FLARES

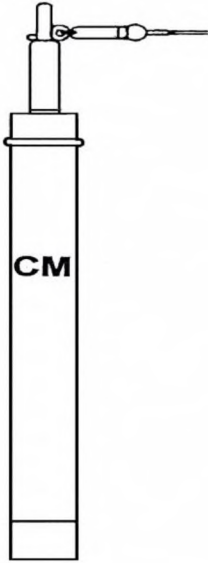

### Russian Flare, SM

Length w/o fuze: 278.00mm (10.94in)

Diameter: 25.00mm (0.98in) Overall Weight: 400.00g (14.11oz)

Filler: Illumination mixture

Fuze: MUV, MUV-2 or MUV-3

Tripwire activated fuzes Notes: Color of flare is indicated by color of band at bottom of flare, red, green or white.

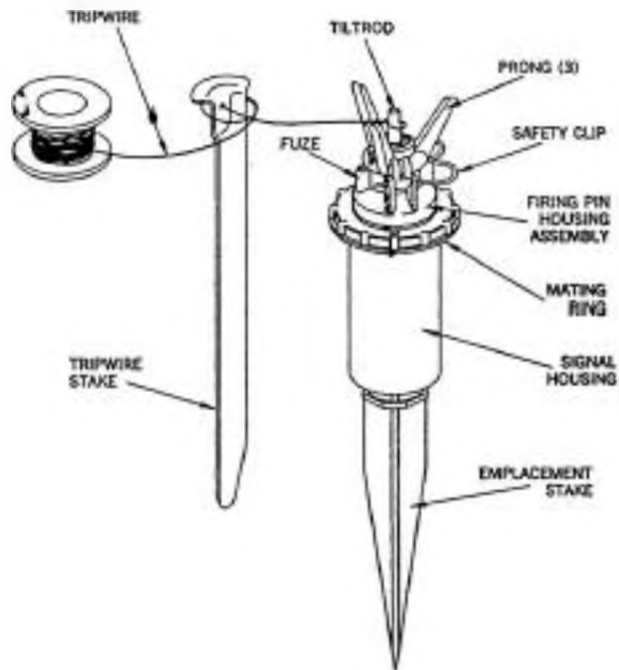

### Italian Flare, Surface, VS-T

Overall Length: 260.00mm (10.24in)

Flare Body: 197.00mm (7.76in)

Max Diameter: 70.00mm (2.76in)

Min Diameter: 50.00mm (1.97in)

Overall Weight: 510.00g (17.99oz)

Filler: Flare mixture NEW: 316.00g (11.15oz)

# SECTION E

## FIRING DEVICES

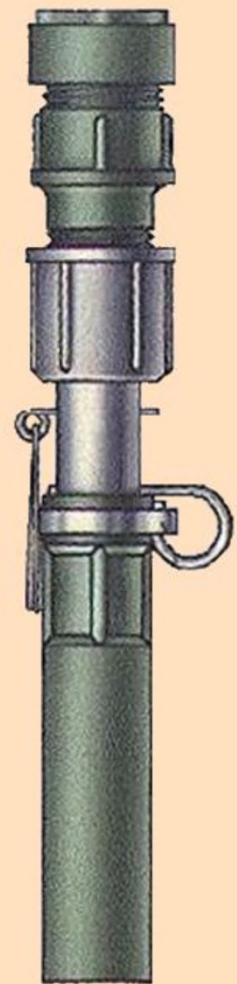

## FIRING DEVICE - PULL



### Russian Firing Device, Pull, MUV

Length: 74.00mm (2.91in)

Diameter: 12.00mm (0.47in)

Notes: Uses MD-5 or MD-2 detonator



### Russian Firing Device, Pull, MUV2

Length: 82.00mm (3.23in)

Diameter: 12.00mm (0.47in)

Notes: Firing device has a lead shear delay

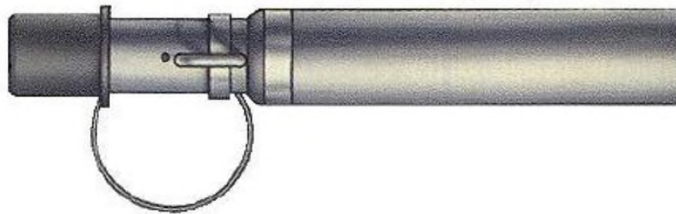

### Russian Firing Device, Pull, MUV3

Length: 86.00mm (3.39in)

Diameter: 13.00mm (0.51in)

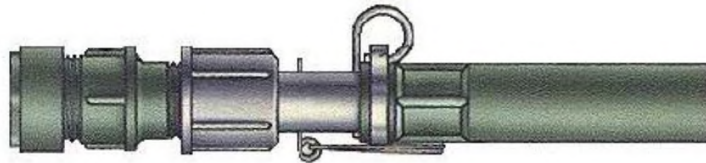

### Russian Firing Device, Pull, MUV4

Length: 75.00mm (2.95in)

Diameter: 17.00mm (0.67in)



### Pakistani Firing Device, Pull, No.4 MK1 (NO4MK1)

Exposed Length of Body: 57.00mm (2.24in)

Diameter: 12.00mm (0.47in)

Overall Weight: 35.40g (1.25oz)

## FIRING DEVICES



### **Russian Fuze, Mine, MVZ-57 (MVZ57)**

Exposed height: 28.00mm (1.10in)

Diameter: 92.00mm (3.62in)

Filler: PETN NEW: 2.00g (0.07oz) Notes: Type: Pressure

# SECTION F

## MORTAR AMMUNITION



## 60 mm MORTARS

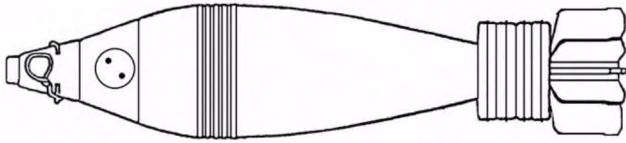

**Yugoslav Mortar, 60mm, HE, M73**  
 Length Overall: 292mm,  
 Fuze: Yugoslav fuze, PD, UT M68P1 / M69 /  
 M70 / UT M93

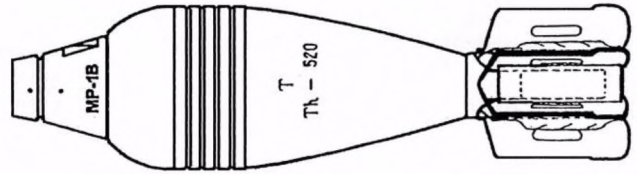

**Chinese Mortar, 60mm, HE, Model Unknown**  
 Length w/o Fuze: 184mm,  
 Fuze: Chinese fuze, PD, MP-18

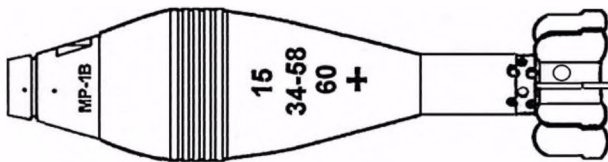

**Chinese Mortar, 60mm, HE, Model Unknown**  
 Length w/o Fuze: 200mm

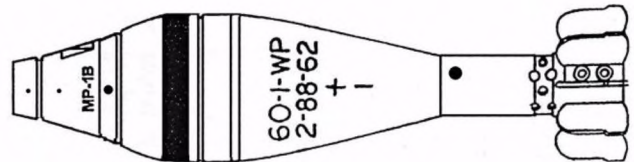

**Chinese Mortar, 60mm, Smoke (WP), Type 60-1**  
 Length: 202mm  
 Fuze: Chinese Fuze, PD, MP-1B



**Iraqi Mortar, 60mm, HE, M73**  
 Diameter: 60.00mm (2.36in)  
 Filler: TNT NEW: 257.00g (9.07oz)  
 Fuze: PD, UTM68P1 & PDB335

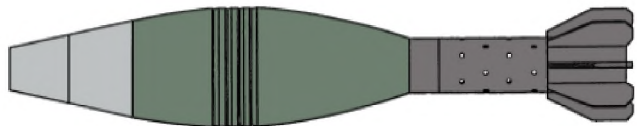

**Iranian Mortar, 60mm, HE, Model Unknown (2)**  
 Length: 311.00mm (12.24in)  
 Diameter: 60.00mm (2.36in)  
 Overall Weight: 1.60kg (3.52lbs)  
 Filler: TNT NEW: 196.00g (6.91oz)  
 Fuze: PD. Iranian copy of DM111 Series

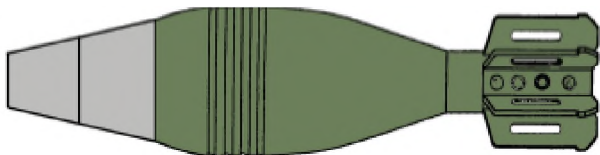

**Iranian Mortar, 60mm, HE, Model Unknown (1)**  
 Overall Length: 244.00mm (9.61in)  
 Diameter: 60.00mm (2.36in)  
 Overall Weight: 1.15kg (2.53lbs)  
 Filler: TNT NEW: 153.00g (5.40oz)  
 Fuze: PD. Iranian copy of DM111 Series



**Former Yugoslavian Mortar, 60mm, HE, M73**  
 Overall Length: 292.00mm (11.50in)  
 Overall Length: 11.49in (291.85mm)  
 Diameter: 60.00mm (2.36in)  
 Filler: TNT NEW: 200.00g (7.05oz)  
 Fuze: PD, UTM68P1

## 81 & 82 mm MORTARS



**Iranian Mortar, HE, 81mm, M43A1**  
 Length w/o Fuze: 309.00mm (12.17in)  
 Length w/ Fuze: 370.00mm (14.57in)  
 Diameter: 81.00mm (3.19in)  
 Overall Weight: 3.98kg (8.76lbs)  
 Fuze: German Fuze, PD, AZ DM 111A2



**Iranian Mortar, 81mm, HE, Model Unknown**  
 Length: 309.00mm (12.17in)  
 Diameter: 81.00mm (3.19in)  
 Filler: TNT NEW: 0.55kg (1.21lbs)  
 Fuze: PD. Iranian copy of DM111 Series.

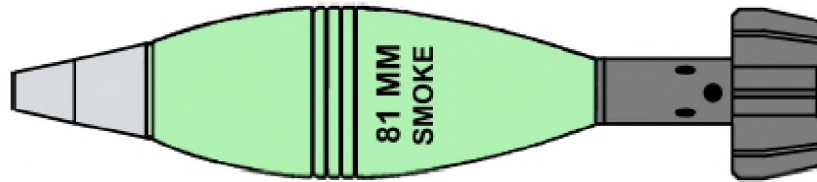

**Iranian Mortar, 81mm, Smoke, WP, Model Unknown**  
 Length w/ Fuze: 380.00mm (14.96in)  
 Diameter: 81.00mm (3.19in)  
 Overall Weight: 4.05kg (8.91lbs)  
 Filler: WP NEW: 450.00g (15.87oz)  
 Fuze: PD, AZ111

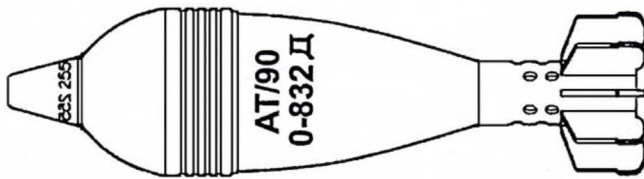

**Russian Mortar, 82mm, Frag, O-832D**  
 Length w/Fuze: 311mm  
 Fuze: Russian Fuze, PD, M-5

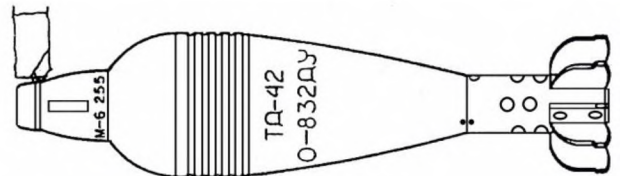

**Russian Mortar, 82mm, Frag, O-832DU**  
 Length w/Fuze: 328mm  
 Fuze: Russian Fuze, PD, M-6

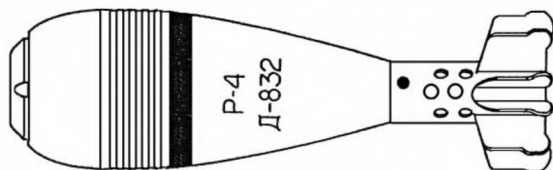

**Russian Mortar, 82mm, Smoke (WP), D-832**  
 Length w/o Fuze: 273

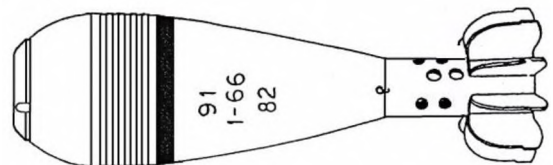

**Russian Mortar, 82mm, Smoke (WP), D-832DU**  
 Length w/o Fuze: 275

## 82 mm MORTARS

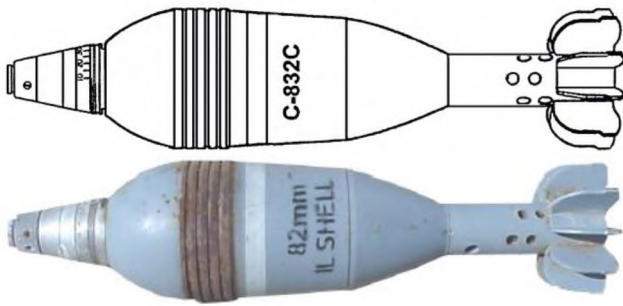

**Russian Mortar, 82mm, Illumination, C-832C**  
Length: 353mm Fuze: Russian Fuze, PTT-T1

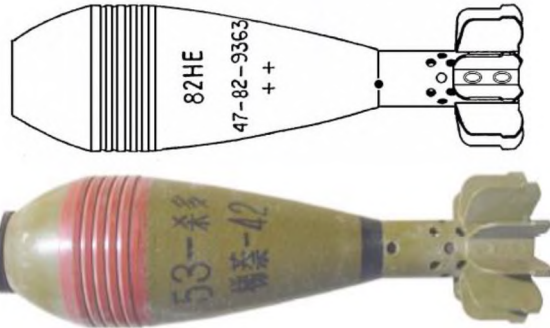

**Chinese Mortar, 82mm, HE, Type 53**  
Length: 280mm Fuze: Chinese Fuze, PD, M6/MP-1B

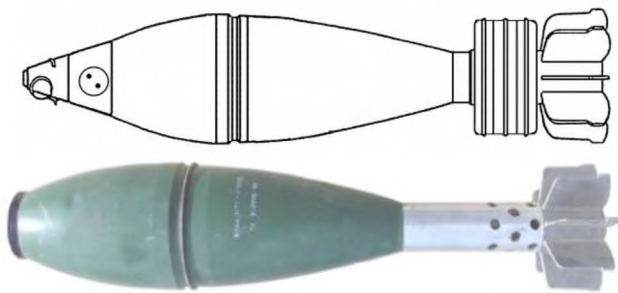

**Yugoslav Mortar, 82mm, HE, M71**  
Length Overall: 369mm Fuze: Yugoslav Fuze, PD, UT M68P1

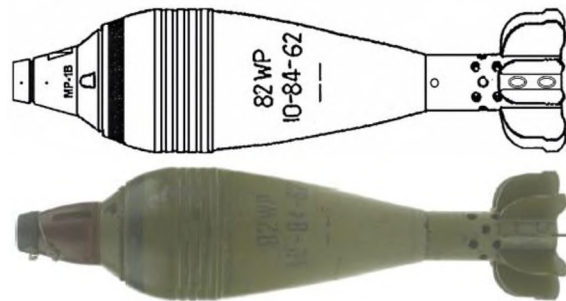

**Chinese Mortar, 82mm, Smoke (WP), Type 53**  
Length w/o Fuze: 276mm Fuze: Chinese Fuze, PD, MP-18



**Yugoslav Mortar, 82mm, Smoke (WP), M71**  
Length Overall: 369mm  
Fuze: Yugoslav Fuze, PD, UT M70P1

## 107 mm MORTARS

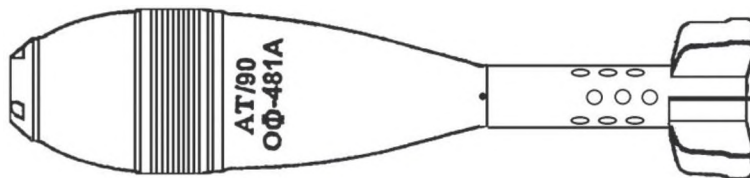

**Russian Mortar, 107mm, HE, OF-481A**  
Length w/o Fuze: 503mm  
Fuze: Russian Fuze, PD, GVMZ-1 / CVM2-7 / Country Unknown, K-107

## 120 mm MORTARS

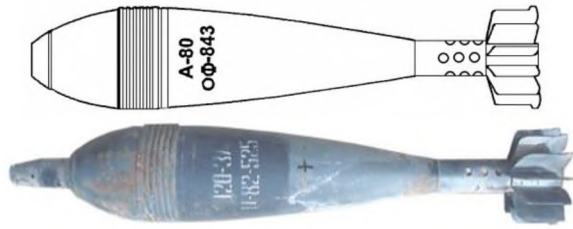

**Russian Mortar, 120mm, HE Frag, OF-843**

Length (Est): 604mm

Fuze: Russian Fuze, PD, GVMZ-7

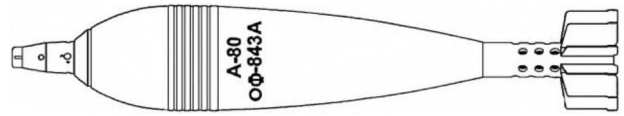

**Russian Mortar, 120mm, HE Frag, OF-843A**

Length : 615mm

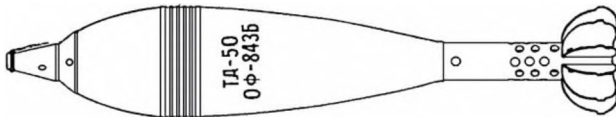

**Russian Mortar, 120mm, HE Frag, OF-843B**

Length Overall: 595mm Fuze: Russian Fuze, PD, M12

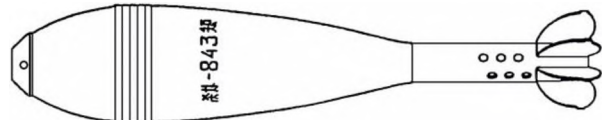

**Chinese Mortar, 120mm, HE, 843**

Length Overall (Est): 595



**Iraqi Mortar, 120mm, HE, 843B**

Overall Length: 549.00mm (21.61in)

Diameter: 120.00mm (4.72in)

Filler: TNT NEW: 1.40kg (3.08lbs)

Fuze: PD, M12 & MP4

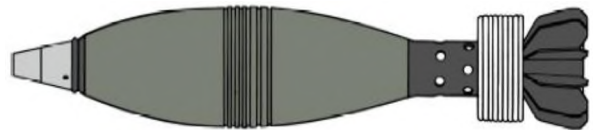

**Iranian Mortar, 120mm, HE, Model Unknown (1)**

Overall Length: 585.00mm (23.03in)

Diameter: 120.00mm (4.72in)

Filler: RDX & TNT NEW: 2.50kg (5.50lbs)

Fuze: PD, AZ111A1



**Iranian Mortar, 120mm, HE, Model Unknown (2)**

Overall Length w/o Fuze: 665.00mm (26.18in)

Diameter: 120.00mm (4.72in)

Filler: TNT NEW: 1.90kg (4.18lbs)

Fuze: PD, MP7A



**Iranian Mortar, 120mm, HE, Model Unknown**

Length w/ Fuze: 740.00mm (29.13in)

Diameter: 120.00mm (4.72in)

Overall Weight: 16.00kg (35.20lbs)

Filler: Comp B - Weight is estimated. NEW: 2.15kg (4.73lbs) Fuze: PD, AZ111



**Chinese Mortar, 120mm, HE, Type 55**

Overall Length: 590.00mm (23.23in)

Diameter: 120.00mm (4.72in)

Filler: TNT NEW: 1.18kg (2.60lbs)

Fuze: MP4, MP12, MP71, MP8

## 160 mm & 240mm MORTARS

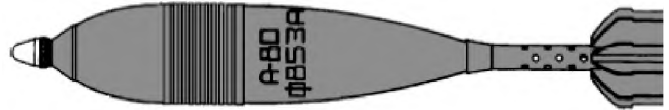
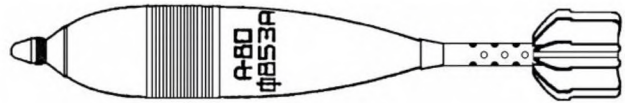

### Russian Mortar, 160mm, HE, F852

Length : 1,200.00mm (47.24in)

Diameter: 160.00mm (6.30in)

Filler: Unknown

Fuze: PD, GVM; PD, GVMZ; PD, GVMZ-1; PD, GVMZ-7

### Russian Mortar, 160mm, HE, F853A

Overall Length: 1,060.00mm (41.73in)

Diameter: 160.00mm (6.30in)

Filler: Amatol NEW: 7.73kg (17.01lbs)

Fuze: PD, GVMZ7

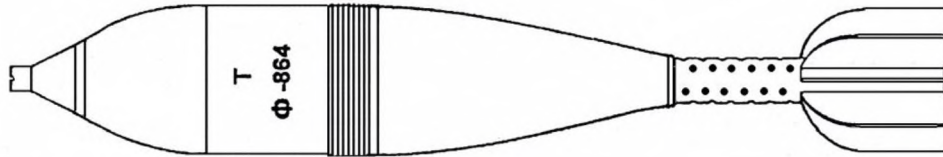

### Russian Mortar, 240mm, HE, F864

Overall Length: 1,560.00mm (61.42in)

Diameter: 240.00mm (9.45in)

Filler: TNT NEW: 31.93kg (70.25lbs)      Fuze: PD, GVMZ-7 & M16

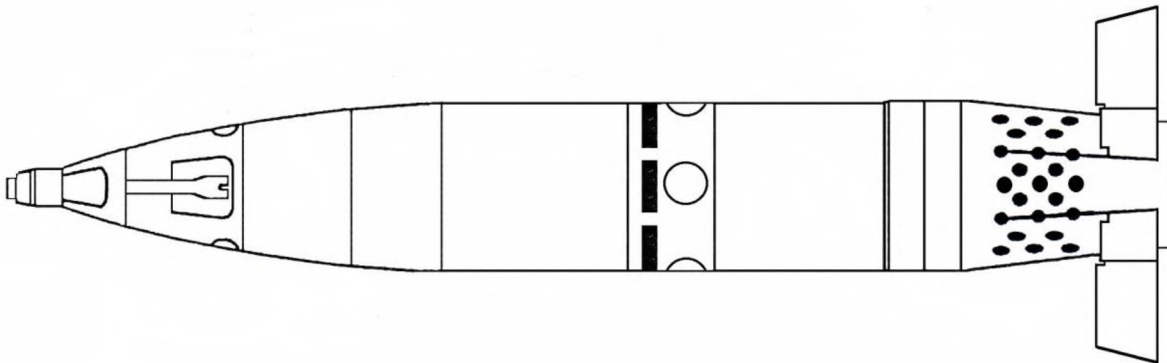

### Russian Mortar, 240mm, HE, Laser-guided, 3F5

Length: 1635mm

# SECTION G

## PROJECTILES



## 30mm AMMUNITION

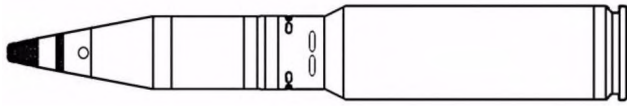

### Russian Cartridge, Frag, HE, Incendiary, 30mm, 3U OF8 (3UOF8)

Cartridge Length Maximum: 292.84mm (11.53in)  
 Projectile Length Maximum: 151.00mm (5.94in)  
 Diameter: 30.00mm (1.18in)  
 Cartridge Weight: 0.84kg (1.85lbs)  
 Projectile Weight: 0.39kg (0.86lbs)  
 Filler: RDX and Aluminum (A-IX-2G) NEW:  
 0.05kg (0.11lbs)  
 Fuze: Point-initiating, Self-destroying (PDSD)  
 A-670M

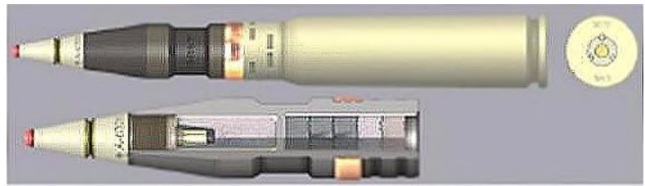
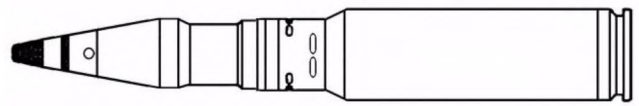

### Russian Cartridge, Frag, Tracer, 30mm, 3U OR6 (3UOR6)

Cartridge Length Maximum: 291.84mm (11.49in)  
 Projectile Length Maximum: 147.50mm (5.81in)  
 Diameter: 30.00mm (1.18in)  
 Cartridge Weight: 0.84kg (1.85lbs)  
 Projectile Weight: 0.37kg (0.81lbs)  
 Filler: RDX and Aluminum (A-IX-2G) NEW:  
 0.01kg (0.02lbs) Fuze: Point-initiating,  
 self-destroying (PDSD) A-670M

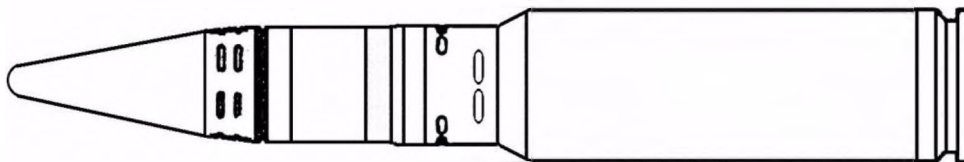

### Russian Cartridge, AP-T, 30mm, 3U BR6 (3UBR6)

Cartridge Length Maximum: 292.84mm (11.53in)  
 Projectile Length Maximum: 148.92mm (5.86in)  
 Diameter: 30.00mm (1.18in)  
 Cartridge Weight: 0.86kg (1.89lbs)  
 Projectile Weight: 0.40kg (0.88lbs)

## 37mm CARTRIDGES

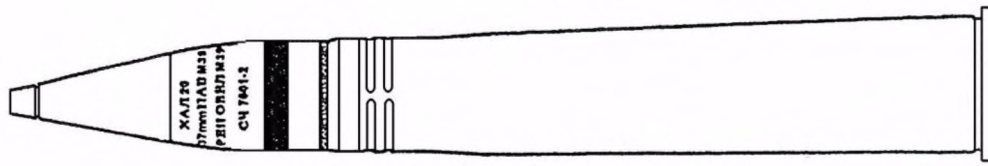

**Yugoslav Cartridge, 37mm, HEI-T, M39**  
Len: 382mm Fuze: PDS, UT M72SP

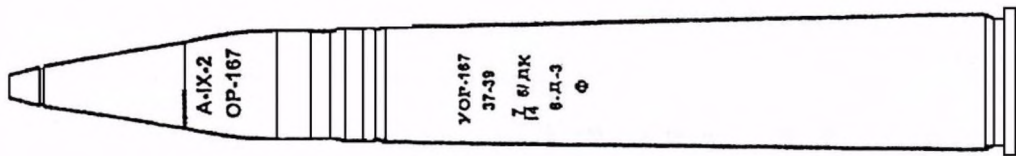

**Soviet Cartridge, 37mm, HEI-T, UOR-167**  
Len: 382mm Fuze: PDS, MG-8

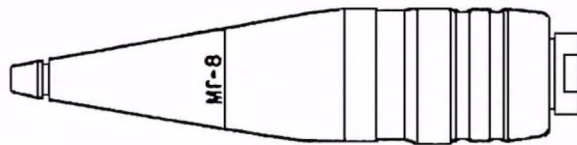

**Soviet Projectile, 37mm, HEI-T, OR-167**  
Len: 173mm Fuze: PDS, MG-8

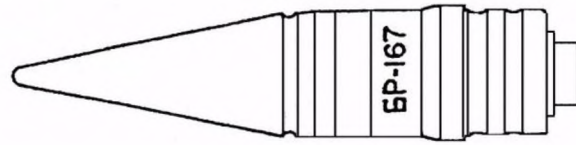

**Soviet Projectile, 37mm, AP-T, BR-167**  
Len: 166mm

## 57mm CARTRIDGES

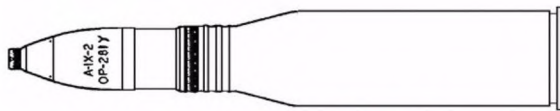

**Russian Cartridge, HE-T, 57mm, OR281U**  
Overall Length: 537.00mm (21.14in)  
Projectile Length: 261.00mm (10.275in)  
Diameter: 57.00mm (2.24in)  
Filler: RDX & Aluminum NEW: 154.00g (5.43oz)  
Fuze: PDS, MG57

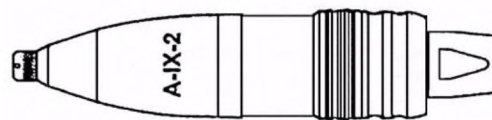

**Russian Projectile, 57mm, APHE-T, BR281U**  
Overall Length: 534.00mm (21.02in)  
Projectile Length: 236.00mm (9.29in)  
Diameter: 57.00mm (2.24in)  
Filler: RDX & Aluminum NEW: 19.00g (0.67oz)  
Fuze: BD, MD10

## 57mm CARTRIDGES

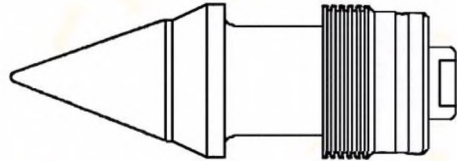
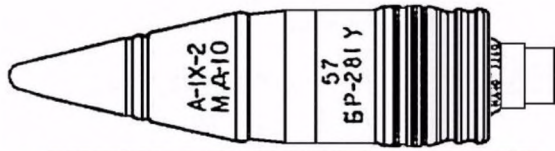

**Soviet Projectile, 57mm, APC-T, BR-281U**  
Len: 236mm Fuze: BD, MD10

**Soviet Projectile, 57mm, HVAP-T, BR-271P**  
Len: 160mm Fuze: None



**Iraqi Projectile, 57mm, HE, Model Unknown**  
Projectile Length: 213.00mm (8.39in)  
Diameter: 57.00mm (2.24in)  
Filler: RDX & Aluminum NEW: 0.17kg (0.37lbs)  
Fuze: PDS



**Iraqi Projectile, 57mm, HE-T, Model Unknown**  
Diameter: 57.00mm (2.24in)  
Fuze: PDS



**Iraqi Cartridge, 57mm, HE, Model Unknown**  
Overall Length (Est.): 537.00mm (21.14in)  
Diameter: 57.00mm (2.24in)  
Filler: RDX & Aluminum NEW: 0.17kg (0.37lbs) Fuze: PDS Notes: Data estimated.

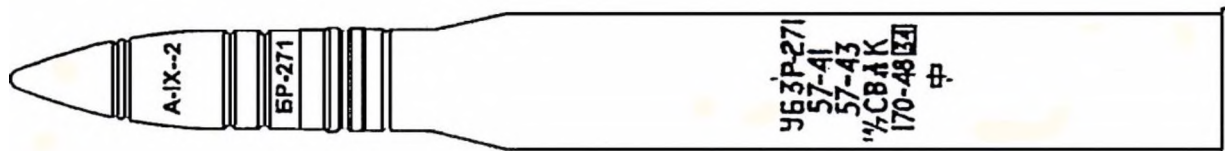

**Soviet Projectile, 57mm, APHE-T, BR-271**  
Len (projectile only): 257mm Fuze: MD-5

## 76mm AMMUNITION

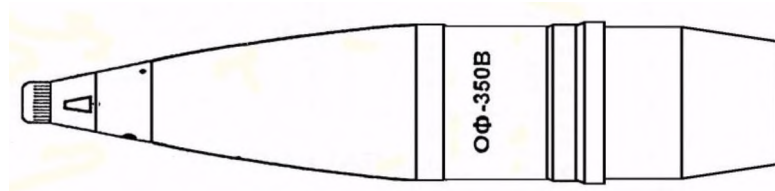

**Russian Projectile, 76, HE, OF-350B**  
 Len w/o Fuze: 309mm Fuze: PD, V429

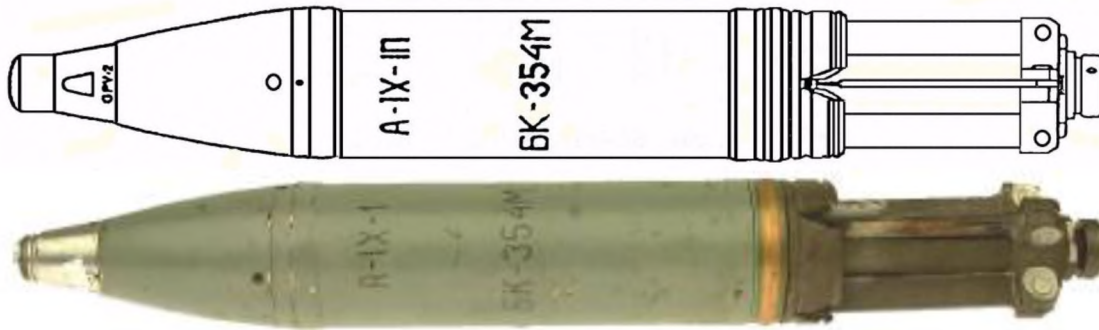

**Russian Projectile, 76, HEAT, BK-354M**  
 Len overall: 566.68mm (22.31in)  
 Fuze: CIS Fuze, PIBD, GPV-2

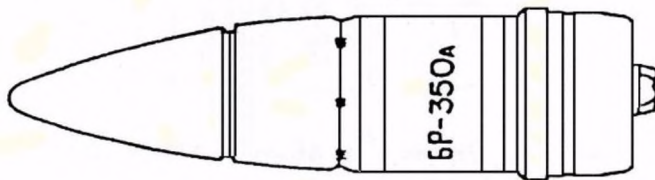

**Russian Projectile, 76, APHE, BR-350A**  
 Len overall: 317.55mm (12.50in)  
 Fuze: CIS Fuze, Base Detonating, MD5

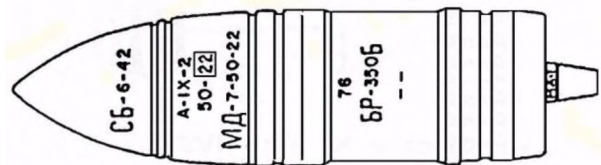

**Russian Projectile, 76, APHE, BR-350B**  
 Len overall: 274.70mm (10.81in)  
 Fuze: CIS Fuze, Base Detonating, MD5/MD7 & MD8

## 85mm AMMUNITION

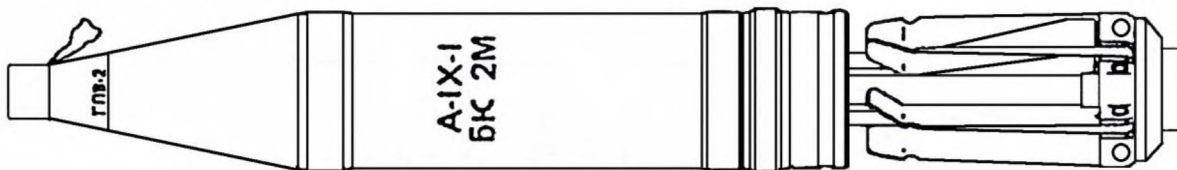

**Soviet Projectile, 85mm, HEAT-FS, BK 2M**  
 Len overall: 624mm Fuze: Soviet Fuze, PIBD, GPV-2

# 85mm AMMUNITION

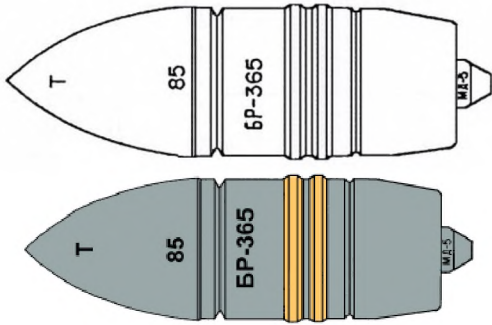

**Soviet Projectile, 85mm, APHE-T, BR-365**  
 Len overall: 337mm Fuze: Soviet Fuze, BD, MD-5

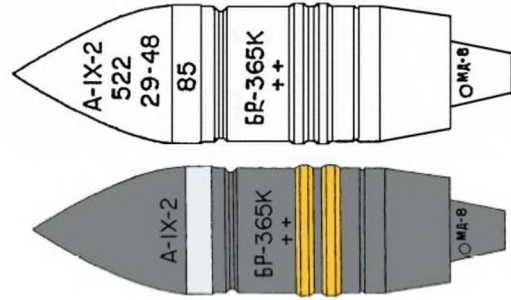

**Yugoslav Projectile, 85mm, APHE, BR-365K**  
 Len overall: 303mm Fuze: Soviet Fuze, BD, MD-8

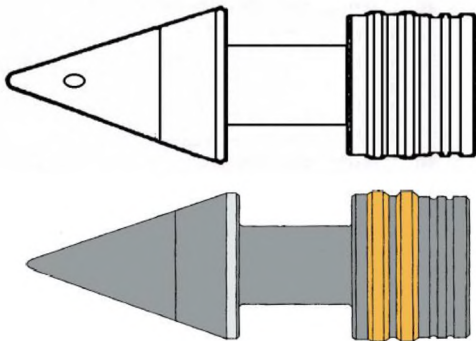

**Yugoslav Projectile, 85mm, HVAP-T, BR-365P**  
 Len overall: 259mm Comment: Copy of the Soviet BR-365 series projectile

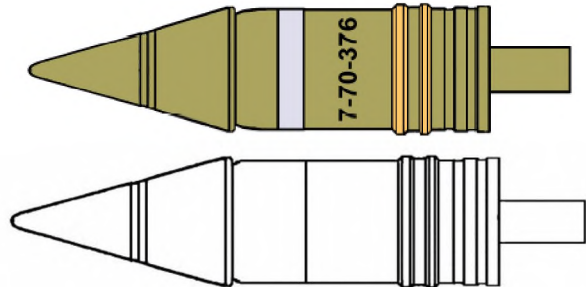

**Chinese Projectile, 85mm, APHE-T, Type-367**  
 Len overall: 362mm Fuze: Soviet Fuze, BD, DRB2 & Type 2

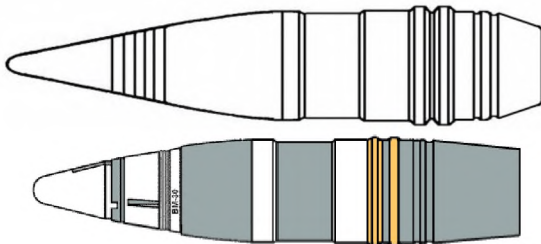

**Soviet Projectile, 85mm, HE, O-365**  
 Len: w/o Fuze: 287.00mm (11.30in)  
 Diameter: 85.00mm (3.35in)  
 Filler: TNT NEW: 0.65kg (1.43lbs)  
 Fuze: PTT, T5 & T11 / MT, VM30 VM30L & VM30L1

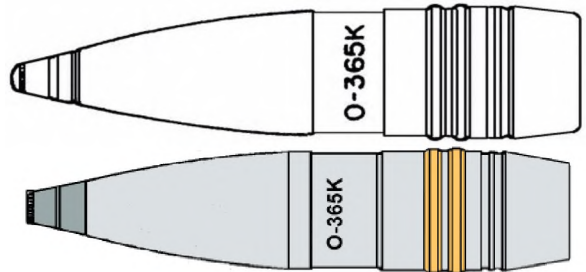

**Soviet Projectile, 85mm, HE, O-365K**  
 Len overall: 367mm Fuze: Soviet Fuze, PD, KTM-1 & MGN / Yugoslav Fuze, PD UT M67

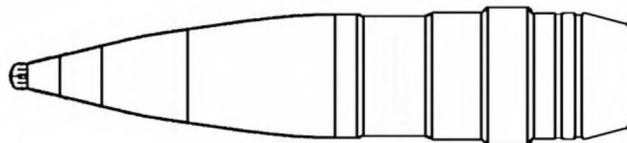

**Soviet Projectile, 85mm, HE, O-367**  
 Len overall: 357mm Fuze: Soviet Fuze, PD, KTM-1U / KTMZ-1U / MGN

# 100mm AMMUNITION For the T-12 AT GUN

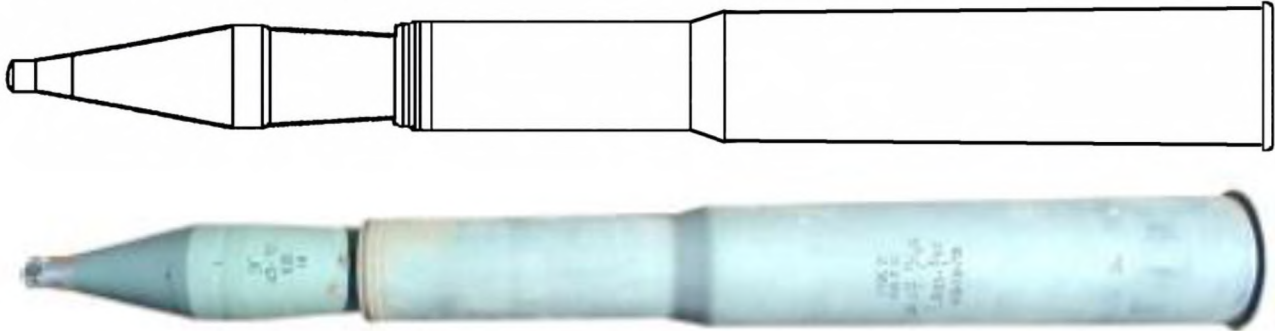

**Russian Cartridge, HEAT-T, 100mm, UBK2**  
 Overall Length: 1,285.00mm (50.59in)  
 Diameter: 100.00mm (3.94in)  
 Notes: Uses BK-2 HEAT Projo

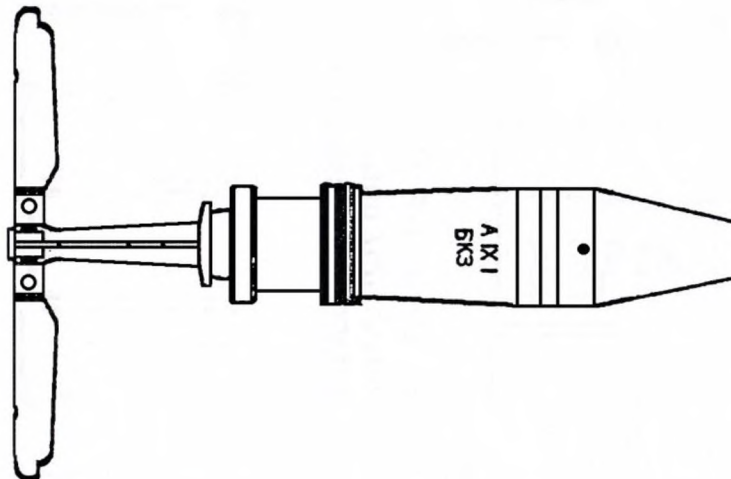

**Russian Projectile, 100mm, HEAT-FS, BK-3**  
 Len: 579mm  
 Fuze: PIBD, GPV-2

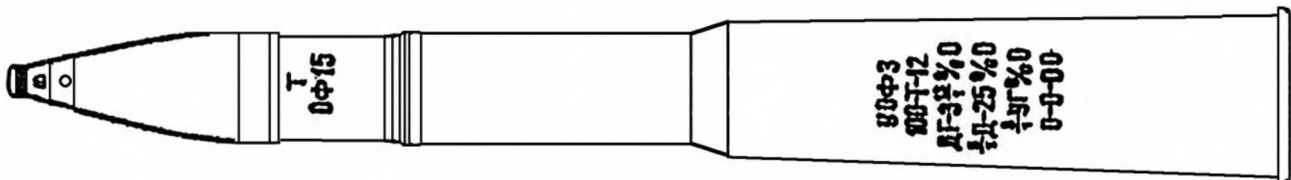

**Russian Projectile, 100mm, HE-FS, OF-15**  
 Len overall: 1285mm (Est)  
 Fuze: Russian Fuze, PD, V29

# 100mm AMMUNITION



## Russian Projectile, 100mm, APDS-T, BM20

Length: 475.00mm (18.70in)  
 Max Diameter: 100.00mm (3.94in)  
 Sabot Diameter: 38.00mm (1.50in)  
 Overall Weight Projectile: 3.00kg (6.60lbs)  
 Filler: Tracer Notes: Projectile is steel



## Russian Projectile, 100mm, HEAT, BK5M

Overall Length: 593.00mm (23.35in)  
 Diameter: 100.00mm (3.94in)  
 Filler: RDX NEW: 1.04kg (2.29lbs)  
 Fuze: PIBD, GPV2

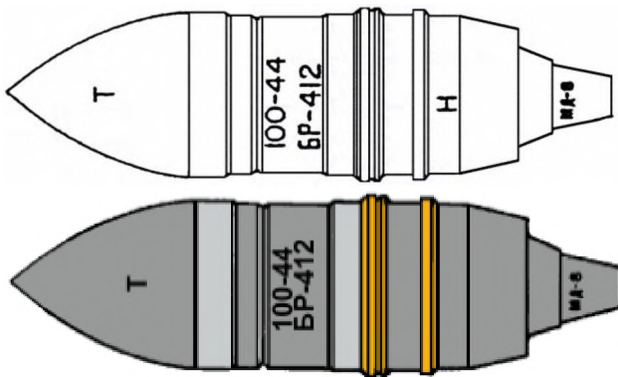

## Russian Projectile, 100mm, APHE, BR412

Overall Length: 362.00mm (14.25in)  
 Diameter: 100.00mm (3.94in)  
 Filler: TNT NEW: 0.06kg (0.13lbs)  
 Fuze: BD, MD8

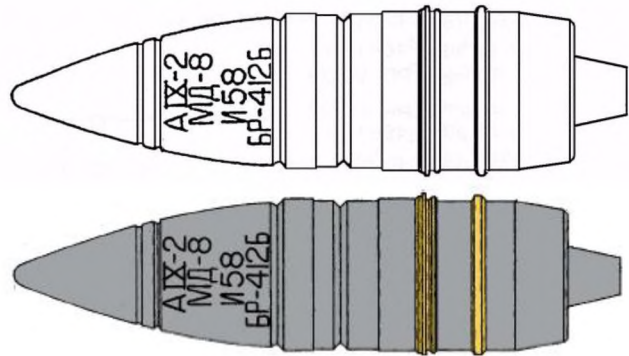

## Russian Projectile, 100mm, APHE-T, BR412B

Length: 362.00mm (14.25in)  
 Diameter: 100.00mm (3.94in)  
 Filler: RDX / Aluminum NEW: 54.00g (1.90oz)  
 Fuze: BD, MD8

# 100mm AMMUNITION

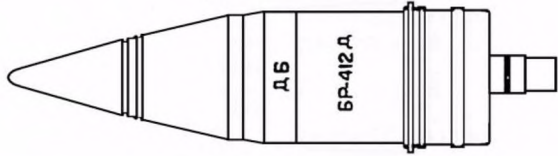

**Russian Projectile, 100mm, APHE, BR412D**  
 Overall Length: 440.00mm (17.32in)  
 Diameter: 100.00mm (3.94in)  
 Filler: RDX & Aluminum NEW: 0.06kg (0.13lbs)  
 Fuze: BD, DBR2

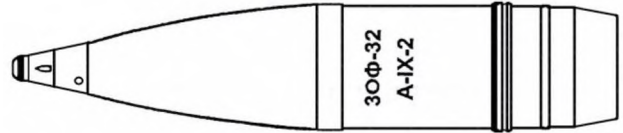
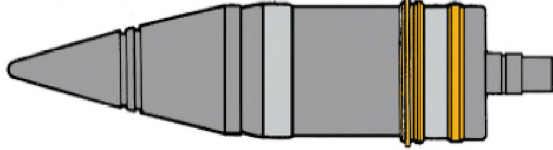

**Russian Projectile, 100mm, HE, OF32**  
 Overall Length: 490.00mm (19.29in)  
 Diameter: 100.00mm (3.94in)  
 Filler: RDX & Aluminum NEW: 1.70kg (3.74lbs)  
 Fuze: PD, V429

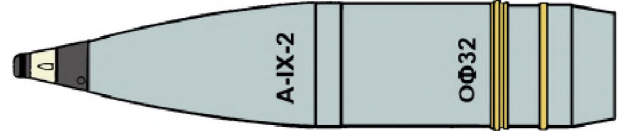

**Russian Projectile, 100mm, HE-FS, OF15**  
 Overall Length: 1,285.00mm (50.59in)  
 Diameter: 115.00mm (4.53in)  
 Overall Weight: 16.70kg (36.74lbs)  
 Filler: TNT NEW: 2.23kg (4.91lbs) Fuze: Russian  
 Fuze, PD, V429

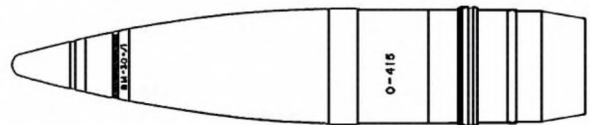

**Russian Projectile, 100mm, HE, O415**  
 Len w/Fuze: 511mm  
 Fuze: Soviet Fuze, MT, VM30 & VM30L

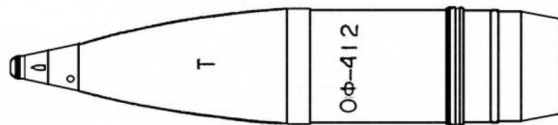

**Russian Projectile, 100mm, HE, OF412**  
 Overall Length: 488.00mm (19.21in)  
 Diameter: 100.00mm (3.94in)  
 Filler: TNT NEW: 1.46kg (3.21lbs)  
 Fuze: PD, V429 & RGM

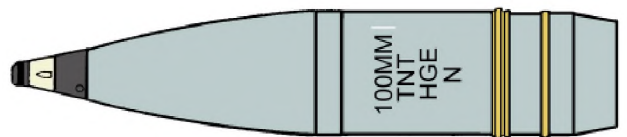
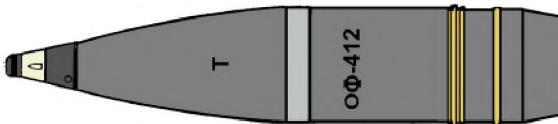

**Iraqi Projectile, 100mm, HE, Model Unknown**  
 Overall Length: 429.00mm (16.89in)  
 Diameter: 100.00mm (3.94in)  
 Filler: TNT NEW: 1.50kg (3.30lbs)  
 Fuze: PD, V429

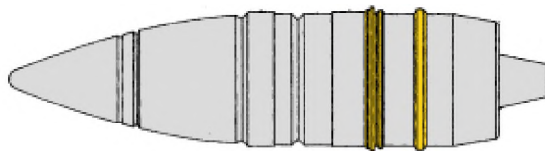

**Iraqi Projectile, 100mm, APHE, Model Unknown**  
 Overall Length: 404.00mm (15.91in)  
 Diameter: 100.00mm (3.94in)  
 Filler: RDX & Aluminum NEW: 0.06kg (0.13lbs)  
 Fuze: BD, MD8



**Russian Projectile, HEAT-FS, 100mm, BK3**  
 Length: 579.00mm (22.80in)  
 Diameter: 100.00mm (3.94in)  
 Filler: RDX NEW: 840.00g (29.63oz)  
 Fuze: PIBD, GPV2

## 105mm, 107mm AMMUNITION

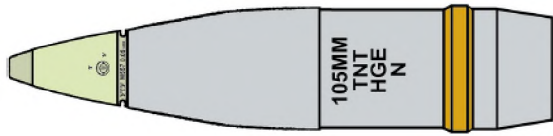

**Iraqi Projectile, 105mm, HE, Model Unknown**  
 Length: 434.00mm (17.09in)  
 Diameter: 105.00mm (4.13in)  
 Filler: TNT  
 Fuze: PD, M557

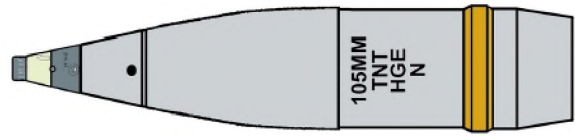

**Iraqi Projectile, 105mm, HE, Model Unknown w/ Adapter**  
 Diameter: 105.00mm (4.13in)  
 Filler: TNT  
 Fuze: PD, RGM2



**Iranian Projectile, 106mm, HEAT, Model Unknown**  
 Length: 990.00mm (38.98in)  
 Diameter: 106.00mm (4.17in)  
 Filler: COMP B NEW: 1.20kg (2.64lbs)  
 Fuze: PIBD, M509A1 Notes: Copy of U.S. M344

## 115mm AMMUNITION

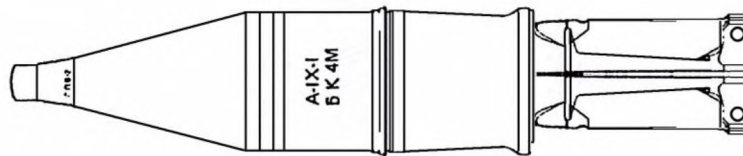

**Russian Projectile, 115mm, HEAT-FS**  
 Len w/Fuze: 633.73mm Fuze: GPV-, PIBD

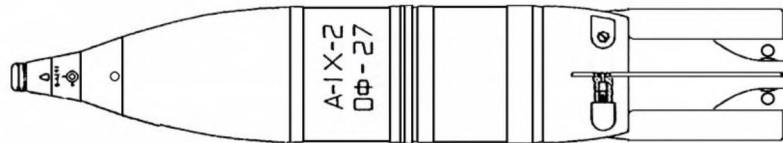

**Russian Projectile, 115mm, HE-FRAG, OF-27**  
 Len: 649.29mm Fuze: V-429E, PD

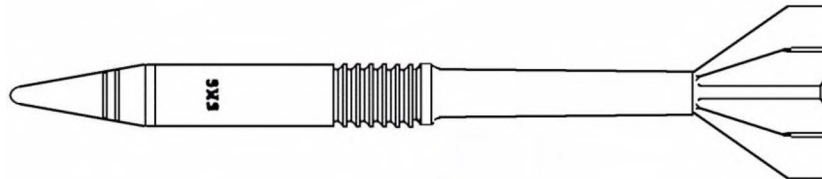

**Russian Projectile, 115mm, APDS-T, BM6**  
 Length: 549.00mm (21.61in) Sabot Diameter: 115.00mm (4.53in)  
 Penetrator: Monobloc Steel w/Steel Cap

## 115mm AMMUNITION

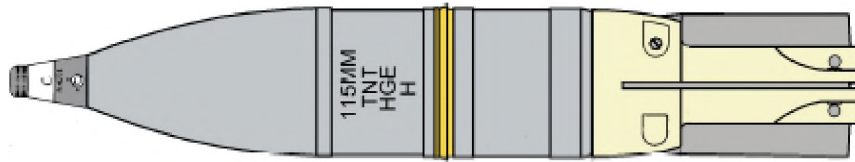

**Iraqi Projectile, 115mm, HE, Model Unknown**

Overall Length: 676.00mm (26.61in)

Diameter: 115.00mm (4.53in) Filler: TNT NEW: 2.72kg (5.98lbs) Fuze: PD, V429E



**Russian Projectile, 115mm, HE, OF18**

Overall Length: 676.00mm (26.61in)

Diameter: 115.00mm (4.53in) Filler: TNT NEW: 2.72kg (5.98lbs) Fuze: PD, V429E



**Russian Projectile, 115mm, HEAT, BK4M**

Overall Length: 634.00mm (24.96in)

Diameter: 115.00mm (4.53in) Filler: RDX NEW: 1.45kg (3.19lbs) Fuze: PIBD, GPV2

## 120mm AMMUNITION for 2S9 GUN



**Russian Projectile, 115mm, HE, OF-49**

Len: 828mm Fuze: PD, V35

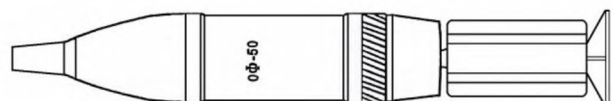

**Russian Projectile, 115mm, HE-RAP, OF-50**

Len: 835mm Fuze: PD, V35

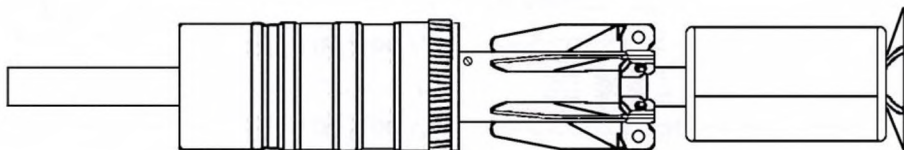

**Russian Projectile, 115mm, HEAT, Model Unknown**

Len: 960mm Fuze: PIBD

# 122mm AMMUNITION

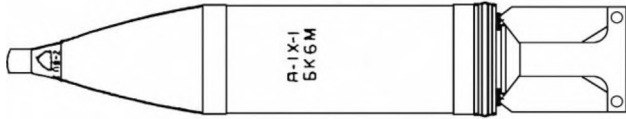

**Russian Projectile, 122mm, HEAT, BK6M**  
 Len w/Fuze: 706.88mm (27.83in) Fuze: Russian  
 Fuze, PIBD, GPV-2

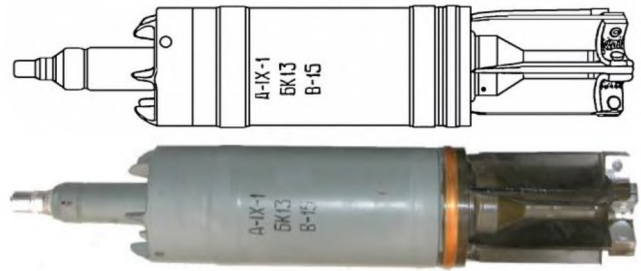

**Russian Projectile, 122mm, HEAT, BK13**  
 Overall Length: 637.00mm (25.08in)  
 Diameter: 122.00mm (4.80in)  
 Filler: RDX NEW: 1.81kg (3.98lbs)  
 Fuze: PIBD, V15

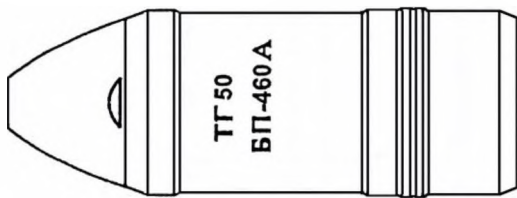

**Russian Projectile, 122mm, HEAT, BP 460A**  
 Len w/o Fuze: 334mm (13.15in) Fuze: Russian,  
 BD, MD-8

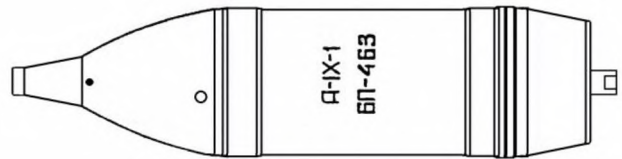

**Russian Projectile, 122mm, HEAT, BP463**  
 Len w/Fuze: 497mm Fuze: Russian Fuze, PIBD,  
 GKN

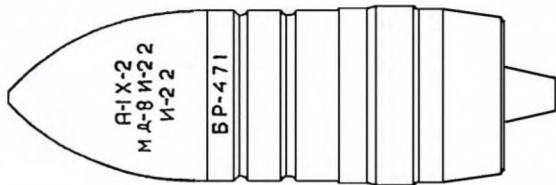

**CIS Projectile, 122mm, APHE, BR-471**  
 Len w/Fuze: 390.40mm (15.37in)  
 Fuze: CIS Fuze, Base Detonating, MD-8

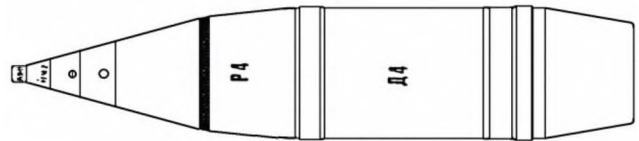

**Soviet Projectile, 122mm, Smoke (WP), D-4**  
 Len w/o Fuze: 499mm (13.15in) Fuze: Soviet  
 Fuze,PD, RGM & RGM-2

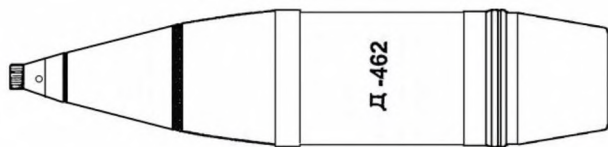

**Soviet Projectile, 122mm, Smoke (WP), D-462**  
 Len w/o Fuze: 545mm (13.15in)  
 Fuze: Soviet Fuze,PD, KTM-2

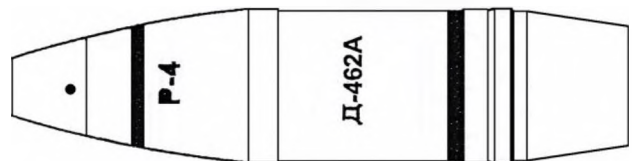

**Soviet Projectile, 122mm, Smoke (WP), D-462A**  
 Len w/o Fuze: 476mm (13.15in)  
 Fuze: Soviet Fuze,PD, RGM-2

# 122mm AMMUNITION



**Iraqi Projectile, 122mm, HE, Model Unknown**  
 Length: 501.00mm (19.72in)  
 Diameter: 122.00mm (4.80in)  
 Filler: TNT NEW: 3.46kg (7.61lbs)  
 Fuze: PD, RGM2

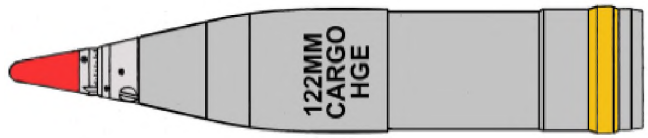

**Iraqi Projectile, 122mm, ICM, Model Unknown**  
 Overall Length: 623.00mm (24.53in)  
 Diameter: 122.00mm (4.80in)  
 Filler: DPICM Submunitions  
 Fuze: MT, VM16L

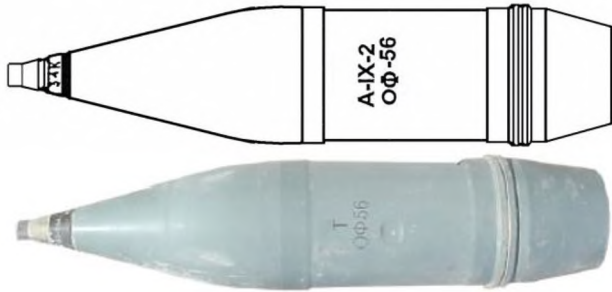

**Russian Projectile, 122mm, HE, OF56**  
 Length w/o Fuze: 501.00mm (19.72in)  
 Diameter: 122.00mm (4.80in)  
 Filler: RDX & Aluminum. TNT may be used as alternate filler. NEW: 4.30kg (9.46lbs)  
 Fuze: PD, RGM2 / MT, V90 / TSQ, D1U



**Soviet Projectile, 122mm, HE, OF 460A**  
 Len: 451mm  
 Fuze: Soviet Fuze, PD, RGM-2 / TSQ, D-1-U

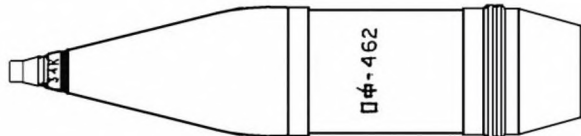

**Soviet Projectile, 122mm, HE, OF 462**  
 Len: 451mm  
 Fuze: Soviet Fuze, PD, RGM-2 / TSQ, D-1 / MTSQ, V-90

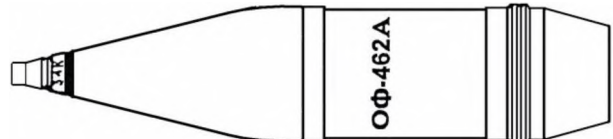

**Soviet Projectile, 122mm, HE, OF 462A**  
 Len: 513mm  
 Fuze: Soviet Fuze, PD, RGM-2 / TSQ, D-1-U

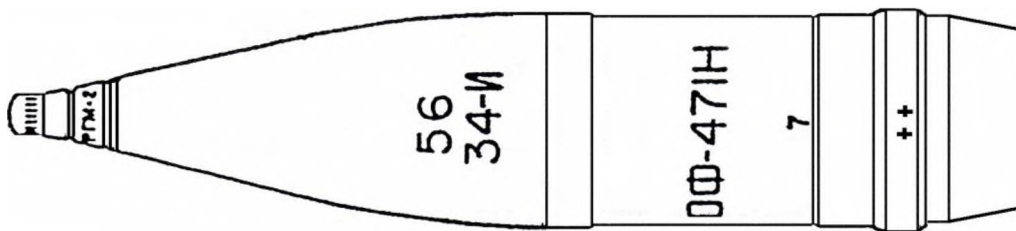

**Soviet Projectile, 122mm, HE, OF 47N**  
 Len w/Fuze: 607mm  
 Fuze: Soviet Fuze, PD, RGM / RGM-2 / TSQ, D-1

## 122mm AMMUNITION

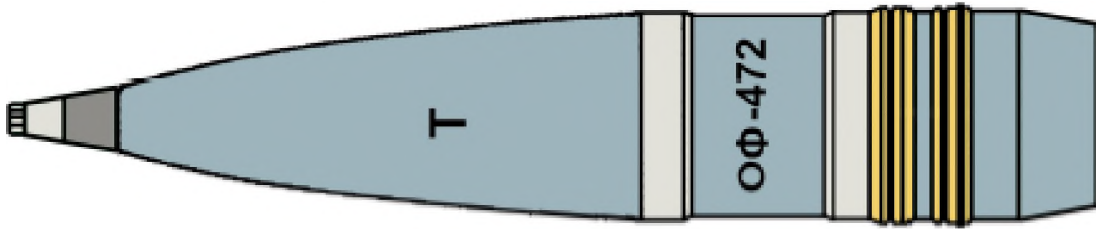

### Russian Projectile, 122mm, HE, OF472

Length w/ Fuze: 624.00mm (24.57in)

Diameter: 122.00mm (4.80in)

Filler: TNT NEW: 3.00kg (6.60lbs) Fuze: PD, V429 & RGM6

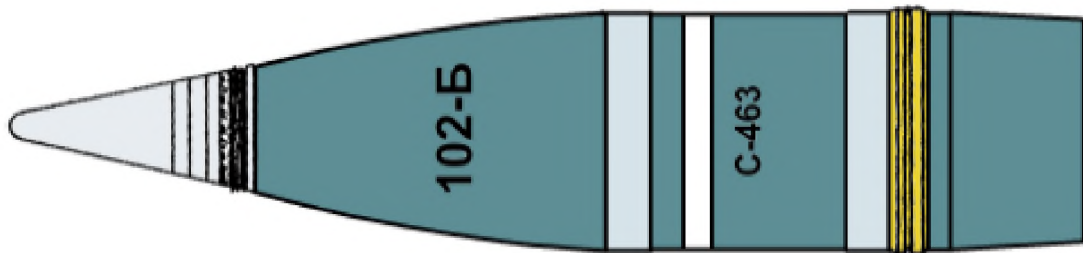

### Russian Projectile, 122mm, Illumination, S463

Length w/o Fuze: 420.00mm (16.54in)

Diameter: 122.00mm (4.80in)

Filler: Illumination composition. NEW: 1.00kg (2.20lbs) Fuze: Time, T7

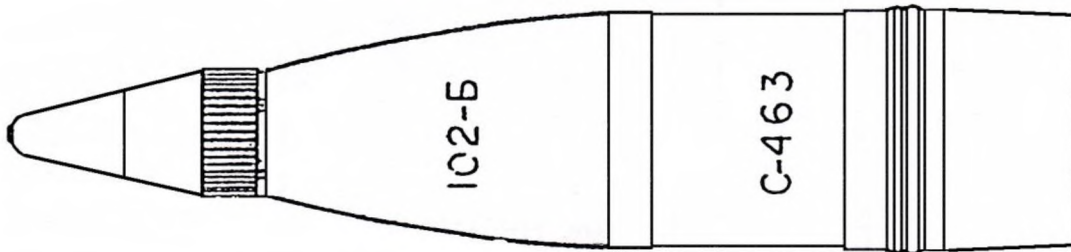

### Russian Projectile, 122mm, HEAT, BK6M

Overall Length: 707.00mm (27.83in)

Diameter: 122.00mm (4.80in)

Filler: RDX NEW: 2.20kg (4.84lbs)

Fuze: PIBD, GPV2

# 125mm AMMUNITION

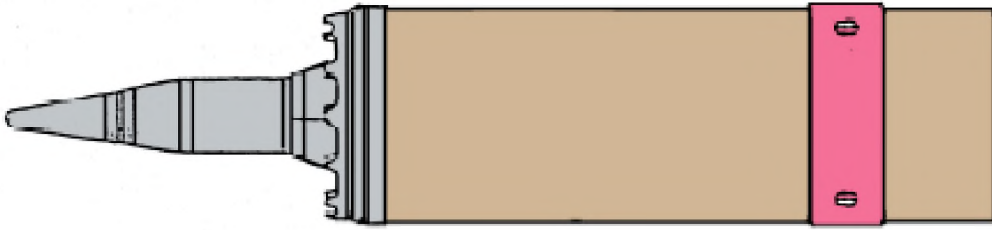

## Russian Projectile, 125mm, APDS-T, BM9

Overall Length: 517.00mm (20.35in)

Diameter: 125.00mm (4.92in)

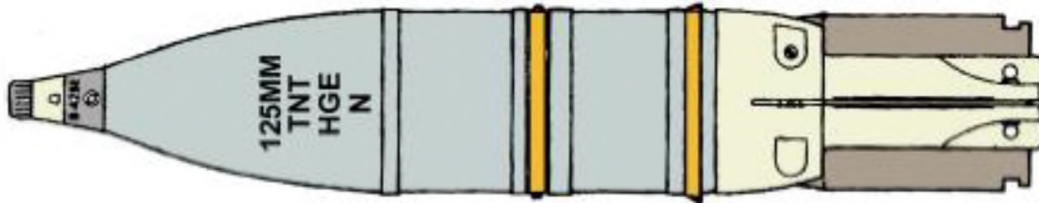

## Iraqi Projectile, 125mm, HE, Model Unknown

Overall Length: 670.00mm (26.38in)

Diameter: 125.00mm (4.92in)

Filler: TNT NEW: 3.15kg (6.93lbs)

Fuze: PD, V429E / TSQ, D1U

Notes: Data is based on the OF19.



## Russian Projectile, 125mm, HEAT, BK14M

Overall Length: 677.00mm (26.65in)

Diameter: 125.00mm (4.92in)

Filler: HMX NEW: 1.85kg (4.07lbs)

Fuze: V-15 PIBD



## Russian Projectile, 125mm, HEAT, BK29M

Overall Length: 680.00mm (26.77in)

Diameter: 125.00mm (4.92in)

Filler: HMX NEW: 1.64kg (3.61lbs)

Fuze: PI

BD, V15

# 130mm AMMUNITION

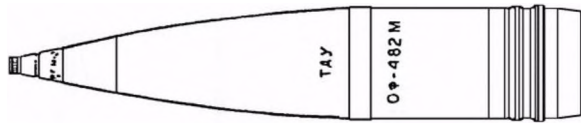

**Russian Projectile, 130mm, HE, OF-482M**  
 Len w/Fuze: 670mm  
 Fuze: Soviet Fuze, MTSQ, V-90 / PD, V-429 & RGM-2

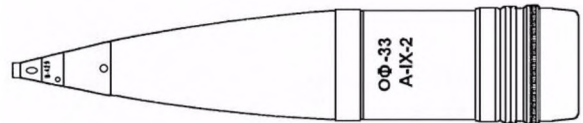

**Russian Projectile, 130mm, HE, OF-33**  
 Len w/Fuze: 612mm  
 Fuze: Russian, PD, V-429

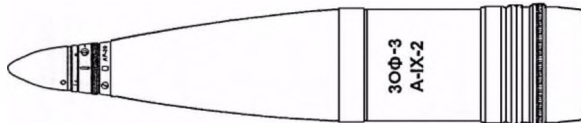

**Russian Projectile, 130mm, HE, 3OF-3**  
 Approximate Len: 555mm  
 Fuze: Russian, Proximity, AR-30

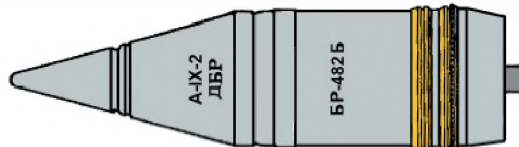
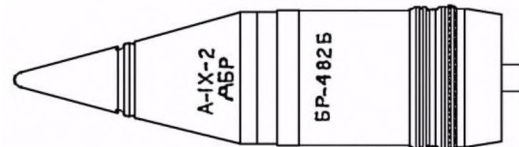

**Russian Projectile, 130mm, APHE-T, BR482B**  
 Overall Length: 496.00mm (19.53in)  
 Diameter: 130.00mm (5.12in)  
 Filler: RDX & Aluminum NEW: 0.13kg (0.29lbs)  
 Fuze: BD, DBR

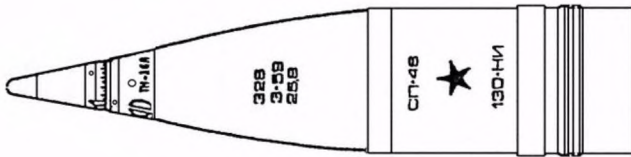

**Russian Projectile, 130mm, Illumination, SP-46**  
 Len w/Fuze: 573mm  
 Fuze: Russian, MT, TM16L

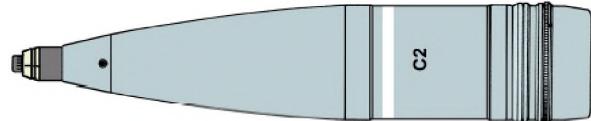
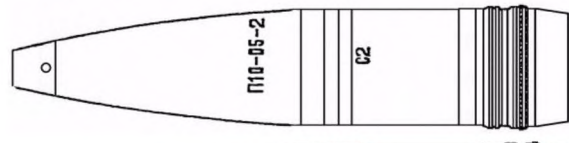

**Russian Projectile, 130mm, Illumination, S2**  
 Len w/o Fuze: 615mm  
 Fuze: Russian, MT, T90

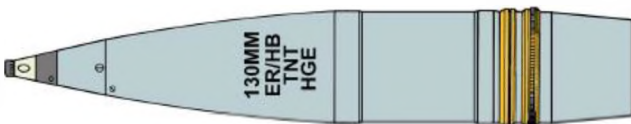

**Iraqi Projectile, 130mm, HE, Model Unknown**  
 Overall Length: 746.00mm (29.37in)  
 Diameter: 130.00mm (5.12in)  
 Filler: TNT NEW: 3.60kg (7.92lbs) Fuze: PD, V429  
 Notes: Extended Range, Hollow Base



**Iraqi Projectile, 130mm, Smoke, WP, Model Unknown**  
 Length w/o Fuze: 613.00mm (24.13in)  
 Diameter: 130.00mm (5.12in)  
 Filler: WP NEW: 3.20kg (7.04lbs) Fuze: PD, V429

## 130mm AMMUNITION

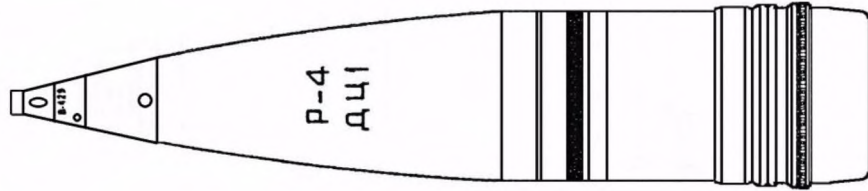

### Russian Projectile, 130mm, Smoke, WP, DTs1

Overall Length: 613.00mm (24.13in)

Diameter: 130.00mm (5.12in)

Filler: WP NEW: 3.20kg (7.04lbs)

Fuze: PD, V429

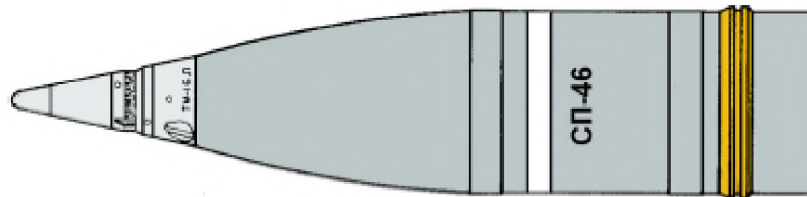
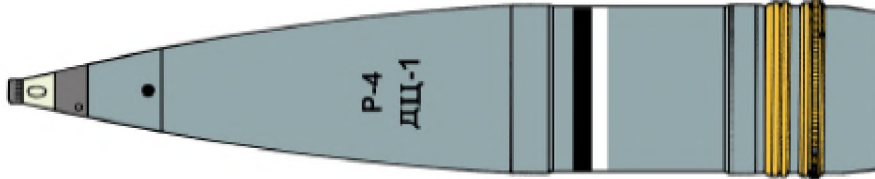

### Russian Projectile, 130mm, Illumination, SP46

Length w/o Fuze: 443.00mm (17.44in)

Length w/ Fuze: 573.00mm (22.56in)

Diameter: 130.00mm (5.12in)

Filler: Illumination composition NEW: 2.40kg (5.28lbs)

Fuze: MT, TM16L & VM60

## 152mm AMMUNITION

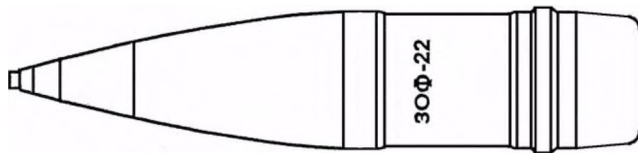

### Russian Projectile, 152mm, HE-RAP, 30F22

Len: Unknown

Fuze: PD



### Russian Projectile, 152mm, ICM, O23

Overall Length: 820.00mm (32.28in)

Diameter: 152.00mm (5.98in) NEW: 1.89kg (4.16lbs)

Fuze: MT Notes: Contains 42, 44mm, 3.5kg submunitions, each containing .045kg of explosives.

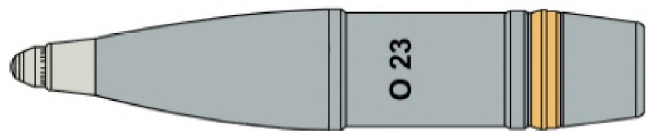

# 152mm AMMUNITION

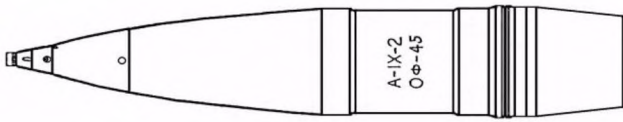

**Russian Projectile, 152mm, OF-45**  
 Len: 864mm  
 Fuze: PD

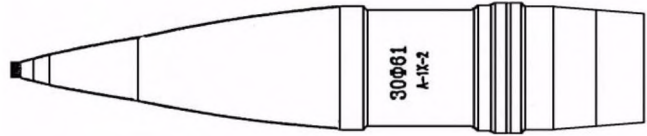

**Russian Projectile, 152mm, HE-BB**  
 Len: 864mm  
 Fuze: PD

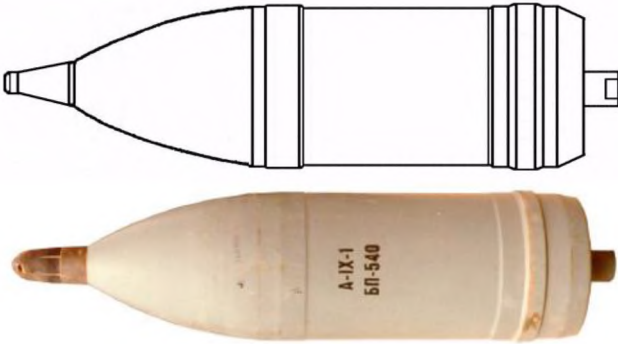

**Russian Projectile, 152mm, HEAT, BP 540**  
 Len w/o Fuze: 531mm  
 Fuze: Russian Fuze, PIBD, GPV-2 / GPV-3

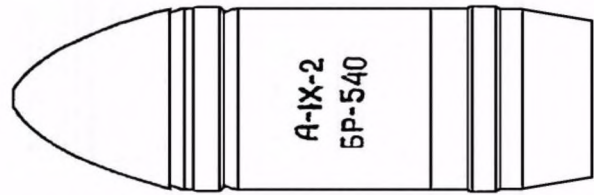

**Russian Projectile, 152mm, APHE, BD**  
 Len: 450mm  
 Fuze: Russian Fuze, BD, MD-7

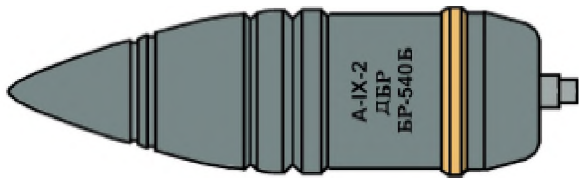

**Russian Projectile, 152mm, APHE, BR540B**  
 Overall Length: 575.00mm (22.64in)  
 Diameter: 152.00mm (5.98in)  
 Filler: RDX/Aluminum/Wax NEW: 471.00g  
 (16.61oz) Fuze: BD: MD-7, MD-8

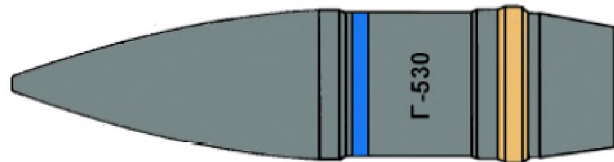

**Russian Projectile, 152mm, Concrete Piercing, G530**  
 Overall Length: 603.00mm (23.74in)  
 Diameter: 152.00mm (5.98in)  
 Filler: TNT NEW: 5.10kg (11.22lbs)  
 Fuze: BD, KTD



**Iraqi Projectile, 152mm, HE, Model Unknown**  
 Overall Length: 710.00mm (27.95in)  
 Diameter: 152.00mm (5.98in)  
 Filler: TNT NEW: 6.20kg (13.64lbs)  
 Fuze: PD, RGM2



**Russian Projectile, 152mm, HE, OF38**  
 Overall Length: 1.19mm (0.05in)  
 Diameter: 152.00mm (5.98in)  
 NEW: 5.80kg (12.76lbs)

# 152mm AMMUNITION

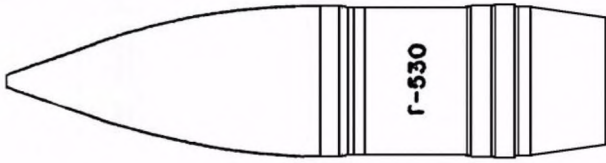

**Russian Projectile, 152mm, CP, G530**  
 Len: 603mm  
 Fuze: Russian Fuze, BD, KTD

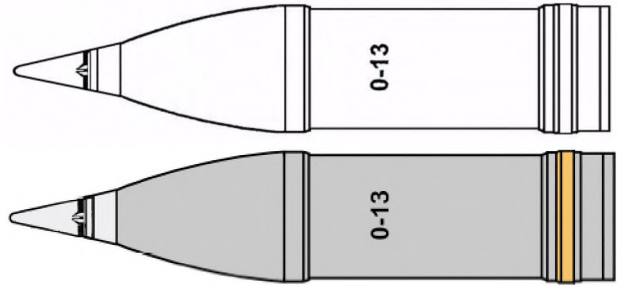

**Russian Projectile, 152mm, HE (ICM) O-13**  
 Len: 664mm  
 Fuze: MT

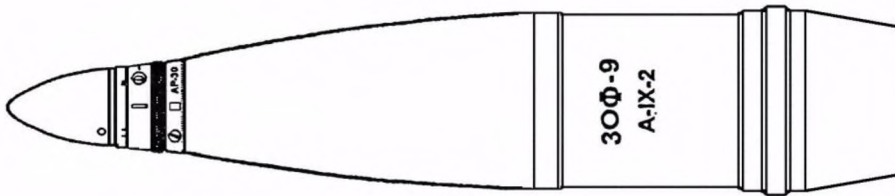

**Russian Projectile, 152mm, HE 30F-9**  
 Len w/o Fuze: Unknown  
 Fuze: Russian, Proximity, AR-30

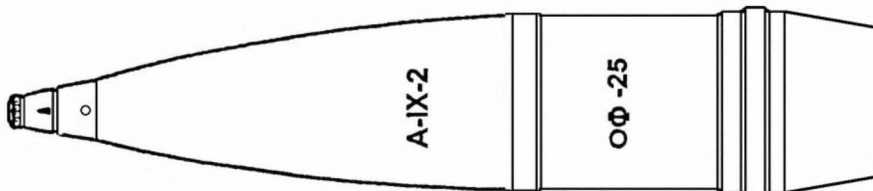

**Russian Projectile, 152mm, HE, OF25**  
 Diameter: 152.00mm (5.98in)  
 Filler: RDX & Aluminum NEW: 6.80kg (14.96lbs)  
 Fuze: PD, RGM2 / MTSQ, V90

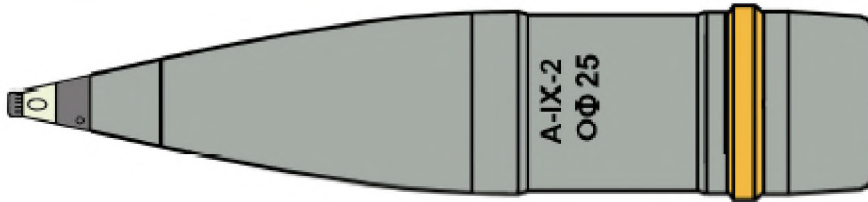

**Russian Projectile, 152mm, HE, OF-540**  
 Len w/Fuze: 710mm Len w/o Fuze: 650mm  
 Fuze: Russian Fuze, PD, RGM / RGM-2 / TSQ, D-1

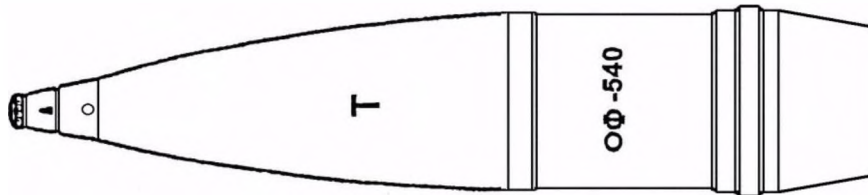

# 152mm AMMUNITION



## **Iraqi Projectile, 155mm, HE, M1A1**

Overall Length: 855.00mm (33.66in)

Diameter: 155.00mm (6.10in)

Filler: TNT & RDX NEW: 7.80kg (17.16lbs)      Fuze: PD & Prox

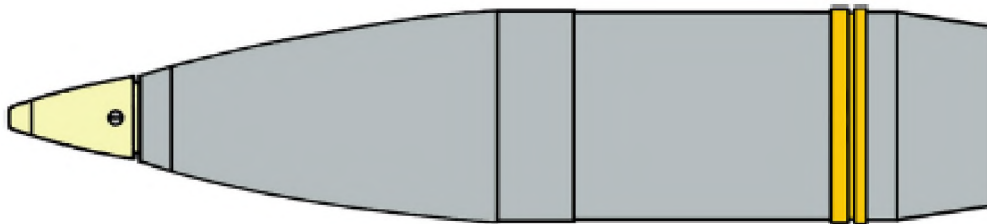

## **Iraqi Projectile, 155mm, HE, Model Unknown**

Length w/o Fuze: 607.00mm (23.90in)

Diameter: 155.00mm (6.10in)

Filler: TNT NEW: 6.62kg (14.56lbs)      Fuze: PD, M577, M739

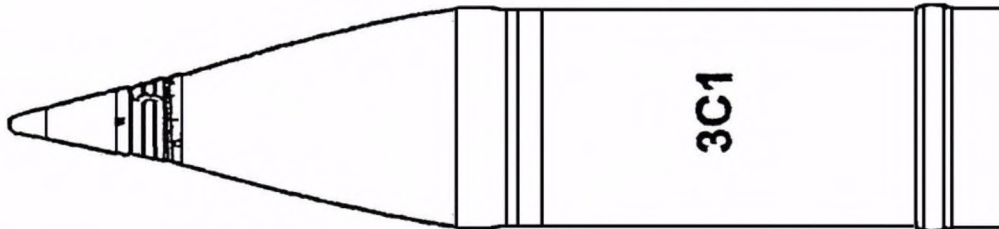

## **Russian Projectile, 152mm, Illumination, S1**

Len w/Fuze: 702mm

Fuze: Russian Fuze, Time, T-7

# SECTION H

## ROCKETS



## 57mm ROCKETS



**Russian Rocket, 57mm, Air-to-Ground, Chaff, S5PB**  
Overall Length: 1,011.00mm (39.80in)  
Diameter: 57.00mm (2.24in)  
Filler: Chaff



**Russian Rocket, Air-to-Ground, HE, 57mm, S5MO**  
Overall Length: 1,005.00mm (39.57in)  
Diameter: 57.00mm (2.24in)  
Filler: RDX NEW: 420.00kg (924.00lbs)  
Fuze: PD, V5M



**Russian Rocket, 57mm, Air-to-Ground, HEAT, S5KO**  
Diameter: 57.00mm (2.24in)  
Filler: RDX NEW: 270.00g (9.52oz)  
Fuze: PIBD Piezo with impact back-up



**Russian Rocket, 57mm, Air-to-Ground, Illumination, S5OB**  
Overall Length: 962.00mm (37.87in)  
Diameter: 57.00mm (2.24in)  
Filler: Illuminating composition  
Fuze: Deceleration discrimination, VB5

## 60 - 73mm ROCKETS



**Iraqi Rocket, 60mm, Ground-to-Ground, HE, OG60**

Overall Length: 736.00mm (28.98in)  
 Diameter: 60.00mm (2.36in)  
 Filler: TNT NEW: 200.00g (7.05oz)  
 Fuze: PD, UTM68P1

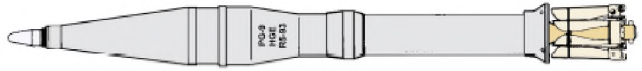

**Iraqi Rocket, 73mm, Ground-to-Ground, HEAT, PG9**

Overall Length: 787.00mm (30.98in)  
 Diameter: 73.00mm (2.87in)  
 Filler: RDX NEW: 0.32kg (0.70lbs)  
 Fuze: PIBDSD, VP9



**Russian Rocket, 64mm, Ground-to-Ground, HEAT, PG18**

Overall Length: 694.00mm (27.32in)  
 Diameter: 64.00mm (2.52in)  
 Filler: HMX NEW: 0.30kg (0.66lbs)  
 Fuze: PIBDSD, VP18



**Russian Rocket, 70mm, Ground-to-Ground, HEAT, PG7M**

Overall Length: 951.00mm (37.44in)  
 Diameter: 70.00mm (2.76in)  
 Filler: RDX NEW: 314.00g (11.08oz)  
 Fuze: PIBDSD, VP7



**Russian Rocket, 70mm, Ground-to-Ground, HEAT, PG7S**

Overall Length: 670.00mm (26.38in)  
 Diameter: 72.00mm (2.83in)  
 Filler: HMX NEW: 318.00g (11.22oz)  
 Fuze: PIBDSD, VP7



**Russian Rocket, Ground-to-Ground, HEAT, 73mm, PG15**

Overall Length: 883.00mm (34.76in) w/o  
 cartridge case: 757.00mm (29.80in)  
 Diameter: 73.00mm (2.87in)  
 Filler: RDX NEW: 320.00g (11.29oz)  
 Fuze: VP-9 PIBD Piezoelectric  
 Notes: Only difference between PG-15 and  
 PG-9 is the propellant cartridge.



**Russian Rocket, 73mm, Ground-to-Ground, HEAT, PG9G**

Overall Length: 787.00mm (30.98in)  
 Diameter: 73.00mm (2.87in)  
 Filler: RDX NEW: 0.32kg (0.70lbs)  
 Fuze: PIBDSD, VP9

## 80 – 85mm ROCKETS



**Russian Rocket, 80mm, Air-to-Ground, HE, S8OF**

Overall Length: 1,350.00mm (53.15in)

Diameter: 80.00mm (3.15in)

Filler: RDX

Fuze: PD, V8



**Russian Rocket, 80mm, Air-to-Ground, HEAT, S8KOM**

Overall Length: 1,340.00mm (52.76in)

Diameter: 80.00mm (3.15in)

Filler: RDX NEW: 997.00g (35.17oz)

Fuze: PIBD Piezo with impact back-up.



**Iranian Rocket, Ground-to-Ground, HEAT, 80mm, PG7TAT**

Overall Length: 813.00mm (32.01in)

Max Diameter: 80.00mm (3.15in)

Notes: This round uses a

Tandem Warhead. Munition has separate fuzes for both warheads.



**Iraqi Rocket, 82mm, Ground-to-Ground, HE, OG82**

Overall Length: 776.00mm (30.55in)

Diameter: 82.00mm (3.23in)

Filler: TNT NEW: 0.44kg (0.97lbs)

Fuze: PD, SH82 & M6

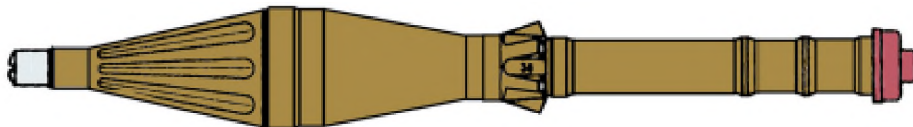

**Iraqi Rocket, 85mm, Ground-to-Ground, HEAT, PG7**

Overall Length: 648.00mm (25.51in)

Diameter: 85.00mm (3.35in)

Filler: RDX NEW: 0.38kg (0.84lbs)

Fuze: Piezoelectric Notes: Copy of Russian

## 85 - 94mm ROCKETS

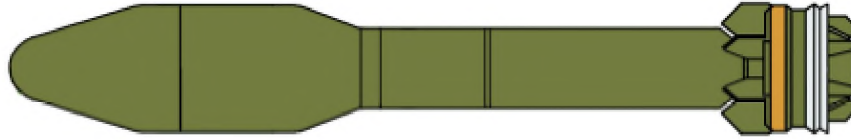

### U.S. Rocket, 89mm, Ground-to-Ground, HEAT, M28A2

Overall Length: 598.00mm (23.54in)

Diameter: 89.00mm (3.50in)

Overall Weight: 4.04kg (8.89lbs)

Filler: Comp B NEW: 0.87kg (1.91lbs)

Fuze: BD, M404



### Russian Rocket, Ground-to-Ground, HEAT, 94mm, PG7L

Diameter: 93.00mm (3.66in)

Fuze: PIBD, VP22

## 107mm ROCKETS



### Iranian Rocket, Ground-to-Ground, HE, 107mm, HASEB

Overall Length: 756.00mm (29.76in) w/ fuze installed: 837.00mm (32.95in)

Diameter: 107.00mm (4.21in)

Filler: TNT NEW: 1.30kg (2.86lbs) Fuze: MJ-1 PD



### Iraqi Rocket, 107mm, Ground-to-Ground, HE, Model Unknown

Length w/o Fuze: 760.00mm (29.92in)

Diameter: 107.00mm (4.21in)

Filler: TNT NEW: 1.30kg (2.86lbs)

Fuze: PD, MJ1 Notes: Data based on the Chinese Type 63-2

## 107mm ROCKETS



**Chinese Rocket, 107mm, HE, Type 63-2**

Len: 840mm Fuze: Fuze, PD, MJ-1

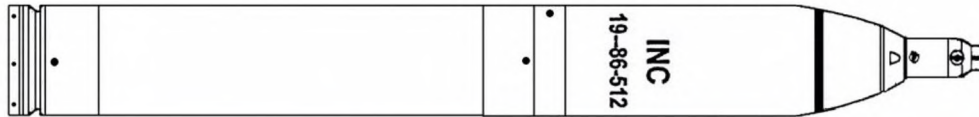

**Chinese Rocket, 107mm, Incendiary, Type 63-1**

Len: 915mm Fuze: Fuze, PD, MJ-1

## 122mm ROCKETS



**Russian Rocket, 122mm, Air-to-Ground, HE, S13**

Overall Length: 2,540.00mm (100.00in)

Diameter: 122.00mm (4.80in) Diameter Warhead: 90.00mm (3.54in)

Filler: RDX & Aluminum NEW: 1.82kg (4.00lbs) Fuze: BD



**Russian Rocket, 122mm, Air-to-Ground, Thermobaric, S13D**

Overall Length: 3,120.00mm (122.83in)

Diameter: 122.00mm (4.80in)

Filler: Fuel-Air Mixture NEW: 14.20kg (31.24lbs)

Fuze: PD Notes: Explosive filler is equivalent to 35 to 40 kg (77 to 88 lb) of TNT.

# 122mm ROCKETS



**Iraqi Rocket, 122mm, Ground-to-Ground, Target, Model Unknown**

Overall Length: 2,190.00mm (86.22in)  
Diameter: 122.00mm (4.80in)

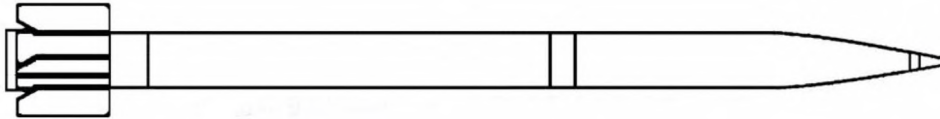

**Russian Rocket, 122mm, HE, 9M22M**  
Len: 1900mm Fuze: Fuze, PD, MRV-U

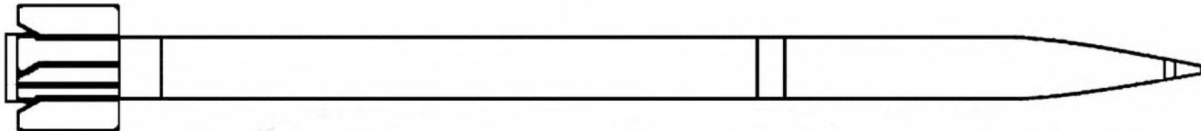

**Russian Rocket, 122mm, HE, 9M28F**  
Len: 2050mm Fuze: Fuze, PD, MRV-U

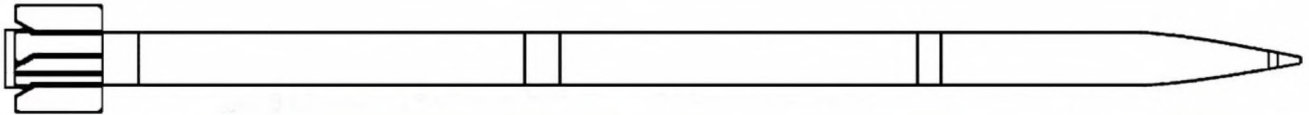

**Russian Rocket, 122mm, HE, 9M22U**  
Len: 2870mm Fuze: Fuze, PD, MRV-U

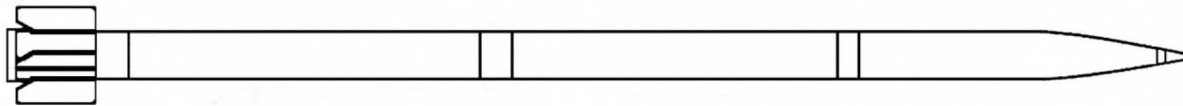

**Chinese Rocket, 122mm, HE, Type 81**  
Len: 2873mm Fuze: Fuze, MJ4 / MJ4A

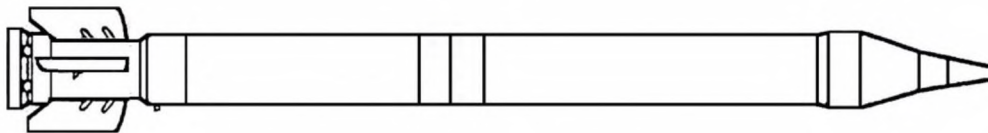

**Russian Rocket, 122mm, Illumination, 9M42**  
Len: 1760mm Fuze: MT

## 132mm & 140mm ROCKETS

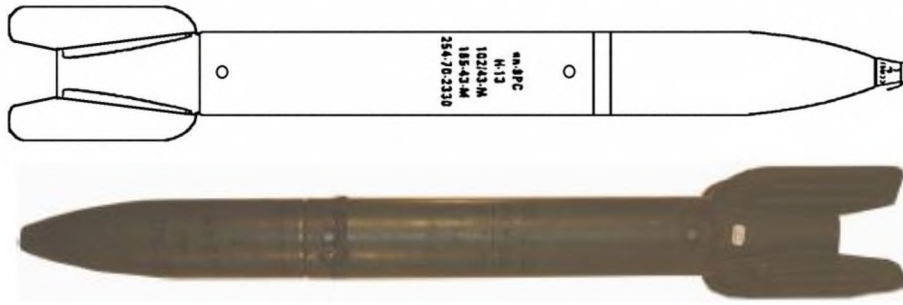

**Rocket, 132mm, HE, M13**  
 Len: 1495mm Fuze: Fuze, PD, GVMZ

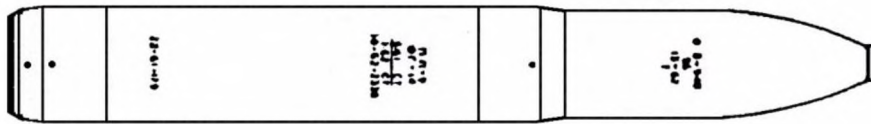

**Rocket, 140mm, HE, M-14-OF**  
 Len: 1053mm Fuze: Fuze, PD, V25

## 220mm ROCKETS

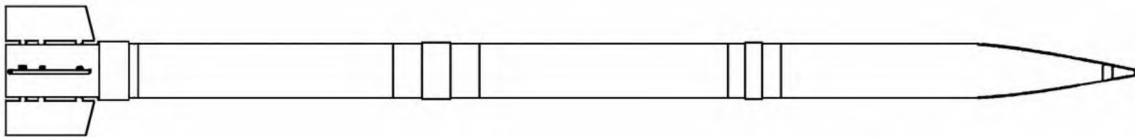

**Russian Rocket, 220mm, HE, 9M27F**  
 Len: 4832mm Fuze: Fuze, PD, MRV-U



### Warhead Designations:

9M27F : High Explosive

9M27K 30 Ea. FRAG HE Bomblets

9M59 9 Ea. PTM-3 AT Mines

9M27K2 24 Ea. PTM-1 AT Mine

9M27K3 314 Ea. PFM-1 AP Mines

## SURFACE TO SURFACE ROCKET

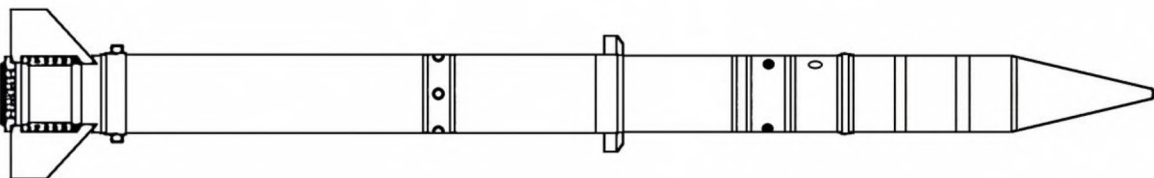

**Russian Rocket, 550mm, HE, FROG-7**  
 Len: 7m Dia: 550mm

# SECTION I

## FUZES

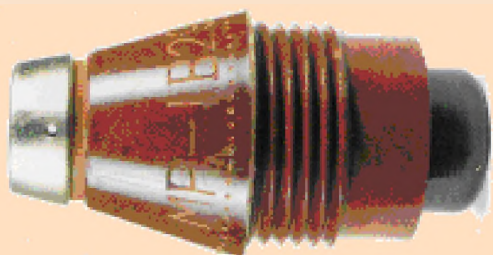

## PROXIMITY FUZES

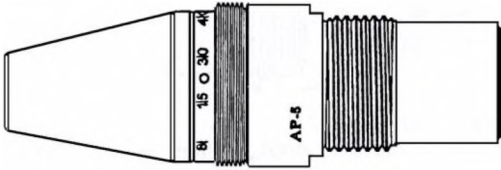

### CIS Fuze, Proximity, AR5

Overall Len: 129mm

Exposed Len: Unknown,

Max Dia: 40mm Used with 122mm, 130mm and 152mm ammunition

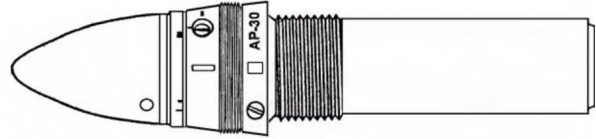

### CIS Fuze, Proximity, AR30

Used with 122mm, 130mm and 152mm ammunition



### Former Yugoslavian Fuze, Projectile, Proximity, M79

Overall Length: 133.00mm (5.24in)

Exposed Length: 76.00mm (2.99in)

Diameter: 60.00mm (2.36in)

Filler: TNT Booster weight: 47.00kg (103.40lbs)



### Chinese Fuze, Projectile, Proximity, MD12A

Overall Length: 204.00mm (8.03in)

Exposed Length: 91.00mm (3.58in)

Diameter: 64.00mm (2.52in)

Filler: RDX NEW: 80.00g (2.82oz)

## PD MORTAR FUZES

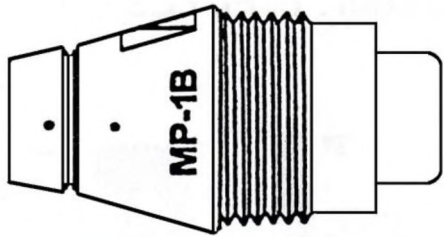

**PRC Fuze, PD, MP-1B**

Overall Len: 74mm Exposed Len: 37mm, Max  
Dia: 40mm

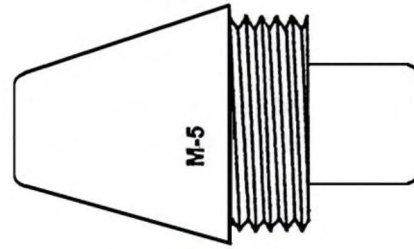

**CIS Fuze, PD, M5**

Overall Len: 66mm Exposed Len: 34mm, Dia:  
39mm

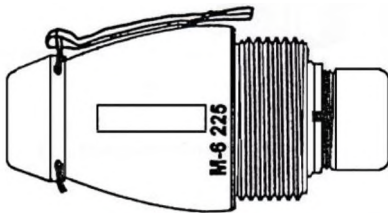

**CIS Fuze, PD, M-6**

Overall Len: 83mm Exposed Len: 52mm, Max  
Dia: 39mm

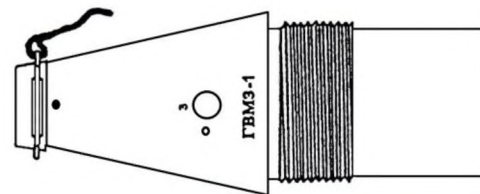

**CIS Fuze, PD, GVMZ-1**

Len: 98mm Exposed Len: 52mm, Dia: 40mm

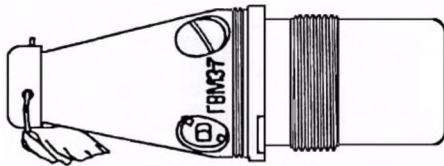

**CIS Fuze, PD, GVMZ-7**

Overall Len: 107mm Exposed Len: 62mm, Max  
Dia: 40mm

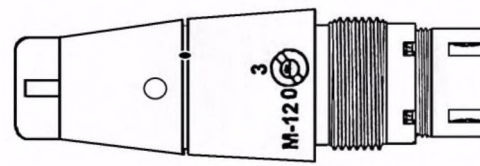

**CIS Fuze, PD, M12**

Overall Len: 117mm Exposed Len: 71mm, Max  
Dia: 40mm

## PD MORTAR FUZES

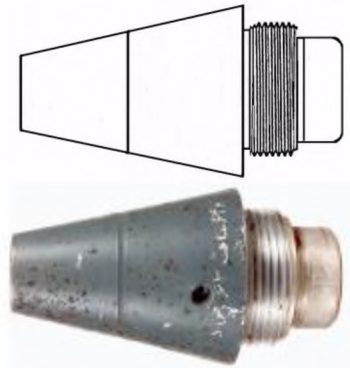

**Iranian Fuze, Mortar, PD, DM111**  
 Overall Length: 87.00mm (3.43in)  
 Exposed Length: 61.00mm (2.40in)  
 Diameter: 49.00mm (1.93in)  
 Filler: Tetryl Booster: 15.00g (0.53oz)

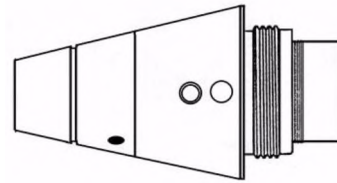

**Iranian Fuze, PD, Unknown Model**  
 Overall Len: 94mm Exposed Len: 67mm, Max  
 Dia: 49mm

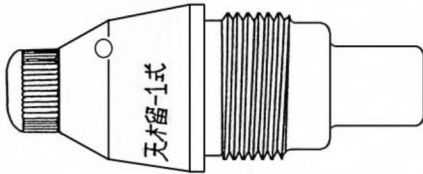

**PRC Fuze, PD, Type 1**  
 Overall Len: 100mm Exposed Len: 47mm, Max  
 Dia: 39mm

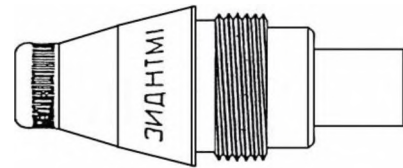

**CIS Fuze, PD, KTM-1**  
 Overall Len: 95mm Exposed Len: 42mm, Max  
 Dia: 40mm Used with 85mm projos

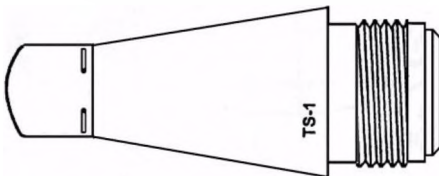

**CIS Fuze, PD, TS-1**  
 Overall Len: 101mm Exposed Len: 75mm, Max  
 Dia: 40mm

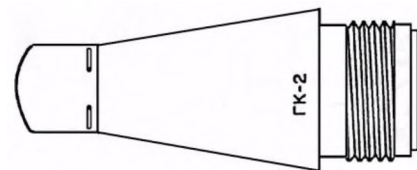

**CIS Fuze, PD, GK-2**  
 Overall Len: 101mm Exposed Len: 75mm, Max  
 Dia: 40mm

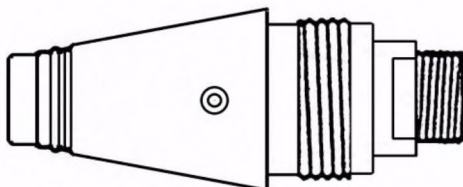

**CIS Fuze, PIBD, GPV-2**  
 Overall Len: 98mm Exposed Len: 56mm, Max  
 Dia: 40mm Used with 76, 85, 100, 122 & 152mm  
 HEAT projos

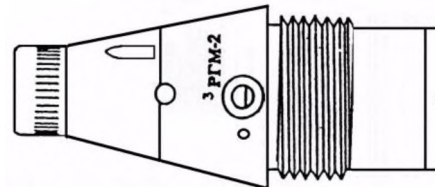

**CIS Fuze, PD, RGM-2 & 2M**  
 Overall Len: 100mm Exposed Len: 57mm, Max  
 Dia: 40mm Used with 122, 130 & 152mm projos

# PD MORTAR FUZES

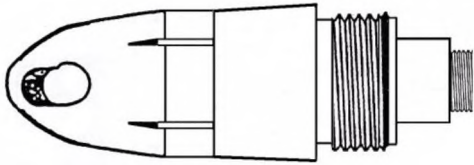

**CIS Fuze, PIBD, GPV-3**

Overall Len: 125mm

Exposed Len: 81mm, Max Dia: 40mm Used with 152mm

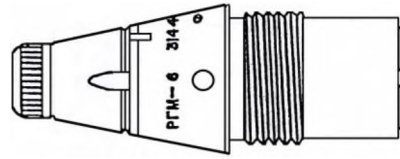

**CIS Fuze, PD, RGM-3**

Overall Len: 100mm

Exposed Len: 51mm, Max Dia: 40mm Used with 100 & 122mm projos

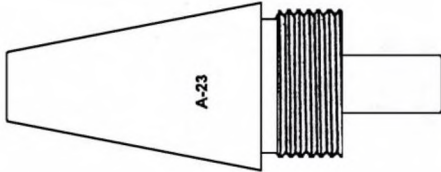

**CIS Fuze, PD, A-23**

Overall Len: 41mm

Exposed Len: 24mm, Max Dia: 17mm

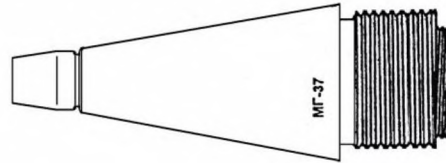

**CIS Fuze, PDSD, MG-37**

Overall Len: 82mm

Exposed Len: 63mm, Max Dia: 30mm

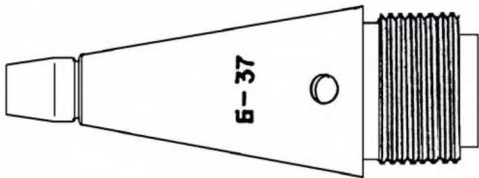

**CIS Fuze, PD, B-37**

Overall Len: 83mm

Exposed Len: 64mm, Max Dia: 30mm

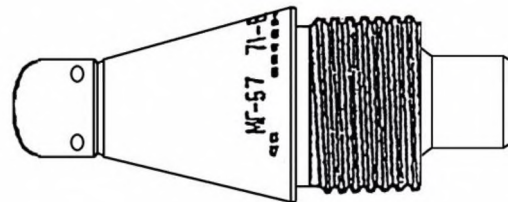

**CIS Fuze, PD, MG-57**

Overall Len: 86mm

Exposed Len: 48mm, Max Dia: 41mm Used with 57mm projos

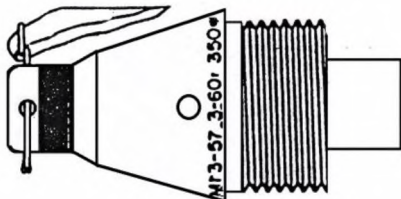

**CIS Fuze, PD, MGZ-57**

Overall Len: 81mm

Exposed Len: 43mm,  
Max Dia: 40mm Used with 57mm projos

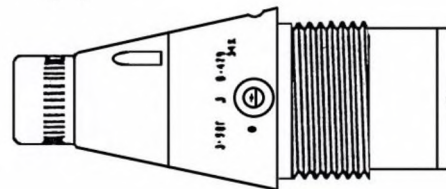

**CIS Fuze, PD, V429**

Overall Len: 105mm

Exposed Len: 58mm,  
Max Dia: 41mm Used with 100, 122 & 130mm projos

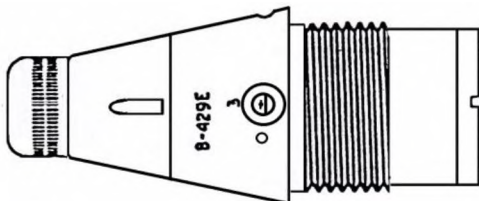

**CIS Fuze, PD, V429E**

Overall Len: 104.9mm

Exposed Len: 58mm,  
Max Dia: 40mm Used with 125mm projos



**Russian Fuze, Mortar, PD, GVMZ**

Overall Length: 98.00mm (3.86in)

Cartridge Length: 52.00mm (2.05in)  
Diameter: 40.00mm (1.57in)

## PD MORTAR FUZES



**Russian Fuze, Mortar, PD, GVMZ7**  
 Overall Length: 106.00mm (4.17in)  
 Exposed Length: 62.00mm (2.44in)  
 Max Diameter: 40.00mm (1.57in)  
 Filler: Tetryl Booster: 15.00g (0.53oz)



**Russian Fuze, Mortar, PD, M12**  
 Overall Length: 117.00mm (4.61in)  
 Exposed Length: 71.00mm (2.80in)  
 Max Diameter: 40.00mm (1.57in)  
 Tetryl: 25.00g (0.88oz)



**Russian Fuze, Mortar, PD, M5M**  
 Overall Length: 68.00mm (2.68in)  
 Exposed Length: 36.00mm (1.42in)  
 Diameter: 39.00mm (1.54in)



**Former Yugoslavian Fuze, Mortar, PD, M68**  
 Overall Length: 90.00mm (3.54in)  
 Diameter: 40.00mm (1.57in)  
 Overall Weight: 163.00g (5.75oz)



**Iraqi Fuze, Mortar, PD, M70P1**  
 Overall Length: 80.00mm (3.15in)  
 Diameter: 46.00mm (1.81in)  
 Overall Weight: 159.00g (5.61oz)



**Russian Fuze, Mortar, PD, V22**  
 Overall Length: 116.00mm (4.57in)  
 Diameter: 40.00mm (1.57in)  
 Overall Weight: 525.00g (18.52oz)



**Russian Fuze, Mortar, TSQ, T1**  
 Overall Length: 71.00mm (2.80in) Exposed  
 Length: 60.00mm (2.36in)  
 Max Dia: 40.00mm (1.57in) Filler: Black Powder  
 NEW: 9.00g (0.32oz)



**Iranian Fuze, Mortar, PD, DM111**  
 Overall Length: 87.00mm (3.43in)  
 Exposed Length: 61.00mm (2.40in)  
 Diameter: 49.00mm (1.93in)  
 Filler: Tetryl Booster: 15.00g (0.53oz)

## PD MORTAR FUZES



**Former Yugoslavian Fuze, Mortar, PTT, M67**

Overall Length: 65.00mm (2.56in)

Exposed Length: 56.00mm (2.20in)

Max Dia: 58.00mm (2.28in)

Filler: Black powder NEW: 6.00g (0.21oz)



**Former Yugoslavian Fuze, Mortar, PTT, M66**

Overall Length: 103.00mm (4.06in)

Exposed Length: 76.00mm (2.99in)

Diameter: 104.00mm (4.09in)

## BASE DETONATION FUZES



**Italian Fuze, Bomb, Nose, Impact, MU05**

Overall Length: 240.00mm (9.45in)

Exposed Length: 110.00mm (4.33in)

Body Diameter: 65.00mm (2.56in)

Max Diameter: 96.00mm (3.78in)



**Russian Fuze, Bomb, Nose & Tail, Long Delay  
Anti-Disturbance, AVPZ**

Overall Length: 227.00mm (8.94in)

Exposed Length: 83.00mm (3.27in)

Diameter- Upper Body: 80.00mm (3.15in)

Diameter- Lower Body: 43.00mm (1.69in)

Filler: Booster NEW Tetryl: 50.00g (1.76oz)

Notes: The fuze is used with HE bombs.



**Russian Fuze, Bomb, Nose & Tail, Impact,  
AV1du**

Overall Length: 214.00mm (8.43in)

Exposed length w/o vanes: 46.00mm (1.81in)

Max Dia: 46.00mm (1.81in)

Filler: Tetryl Booster weight: 51.00g (1.80oz)



**Russian Fuze, Bomb, Tail, Impact, AV527**

Overall Length: 240.00mm (9.45in)

Diameter: 66.00mm (2.60in)

Overall Weight: 1.90kg (4.18lbs)

RDX Booster: 60.75g (2.14oz) Notes: Used with

ZAB 500 SH, Bomb, Incendiary, 500 KG

## BASE DETONATION FUZES



**Russian Fuze, Bomb, Nose, Impact, AMA**  
 Overall Length: 64.00mm (2.52in)  
 Exposed Length: 36.00mm (1.42in)  
 Max Dia: 31.00mm (1.22in)  
 Net Explosive Weight: 7.00g (0.25oz)



**Russian Fuze, Bomb, Nose & Tail, Impact, AVUETM**  
 Overall Length: 209.00mm (8.23in)  
 Exposed Length: 68.00mm (2.68in)  
 Max Dia: 60.00mm (2.36in)

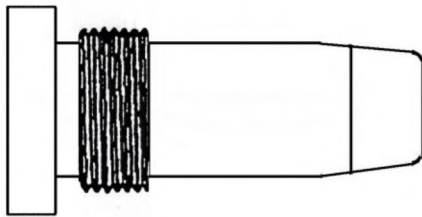

**CIS Fuze, BD, KTD**  
 Overall Len: 109mm, Max Dia: 67mm, Used with  
 152mm projos



**Russian Fuze, Bomb, Nose or Tail, Impact, AH1A**  
 Overall Length: 226.32mm (8.91in)  
 Exposed Length: 84.37mm (3.32in)  
 Max Diameter: 44.00mm (1.73in)  
 Overall Weight: 862.00g (30.41oz)  
 Net Explosive Weight: 49.50g (1.75oz)

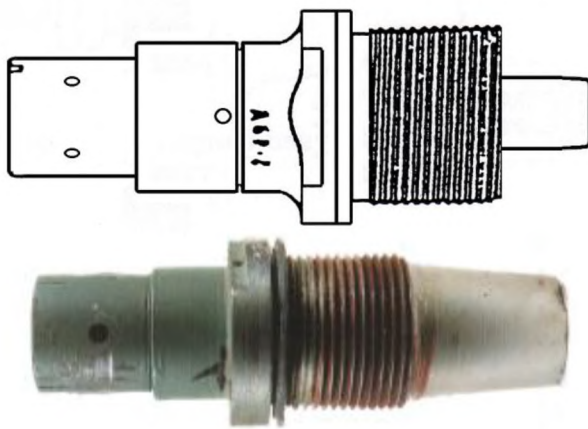

**CIS Fuze, BPD, DBR-2**  
 Overall Len: 98mm Exposed Len: 56mm, Max  
 Dia: 40mm Used with 100 & 130mm projos



**Russian Fuze, Projectile, BD, DBT**  
 Overall Length: 113.00mm (4.45in)  
 Exposed Length: 16.00mm (0.63in)  
 Max Dia: 65.00mm (2.56in) Filler: Tetryl

## BASE DETONATION FUZES



**Russian Fuze, Projectile, BD, KTD**  
 Overall Length: 109.00mm (4.29in)  
 Exposed Length: 12.00mm (0.47in)  
 Max Dia: 66.00mm (2.60in) Filler: Tetryl

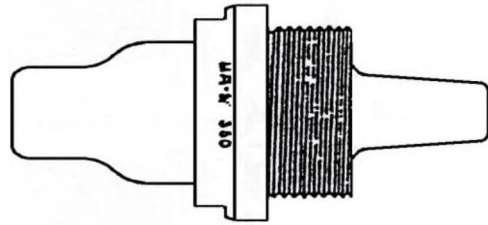

**CIS Fuze, BD, MD-5**  
 Overall Len: 66mm, Exposed Len: 35mm, Max  
 Dia: 29mm, Used with 76mm projos



**Russian Fuze, Projectile, BD, MD10**  
 Overall Length: 70.00mm (2.76in)  
 Exposed Length: 34.00mm (1.34in)  
 Max Dia: 33.00mm (1.30in)  
 Filler: Tetryl NEW: 2.00g (0.07oz)  
 Notes: Used with 57, 76, 85, and 122-mm  
 projectiles.



**Russian Fuze, Projectile, BD, MD7**  
 Overall Length: 63.00mm (2.48in)  
 Exposed Length: 26.00mm (1.02in)  
 Max Dia: 29.00mm (1.14in)  
 Filler: Tetryl NEW: 1.00g (0.04oz)

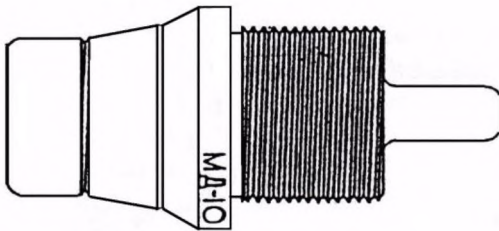

**CIS Fuze, PD, MD-10**  
 Overall Len: 70mm Exposed Len: 33mm, Max  
 Dia: 32mm Used with 57, 76, 85 & 122mm projos

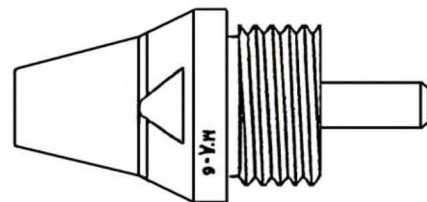

**CIS Fuze, BD, MD-6**  
 Overall Len: 65mm, Exposed Len: 34mm, Max  
 Dia: 32mm



**Russian Fuze, Projectile, BD, MD8**  
 Overall Length: 47.00mm (1.85in)  
 Exposed Length: 17.00mm (0.67in)  
 Max Dia: 34.00mm (1.34in)  
 Filler: Tracer composition NEW: 39.00g (1.38oz)  
 Notes: Used with 76, 85, 100, and 122-mm projectiles.

## TIME & MECH – TIME FUZES

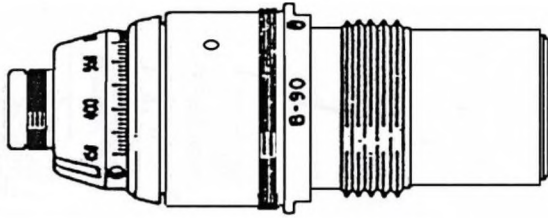

**CIS Fuze, MT, V90**

Overall Len: 108mm

Exposed Len: 61mm,

Max Dia: 41mm, Used with 122 & 130mm projos

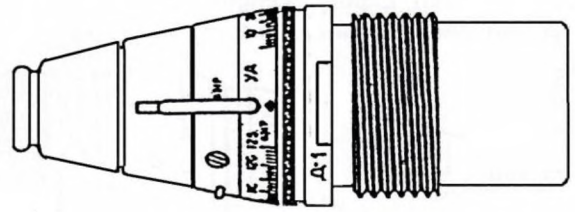

**CIS Fuze, TSQ, D-1**

Overall Len: 105mm

Exposed Len: 60mm,

Max Dia: 40mm, Used with 122 & 152mm projos

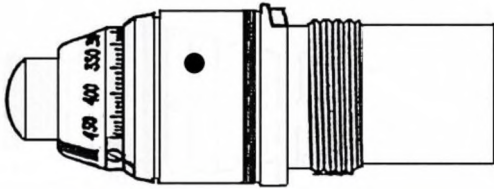

**Russian Fuze, Projectile, MT, T90**

Overall Length: 108.00mm (4.25in)

Exposed Length: 61.00mm (2.40in)

Max Dia: 41.00mm (1.61in)

Filler: Black powder NEW: 29.00g (1.02oz)

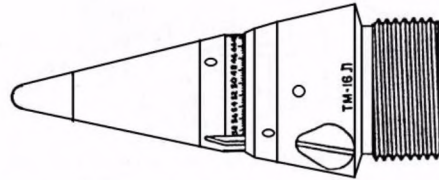

**Russian Fuze, Projectile, MT, TM16L**

Overall Length: 160.00mm (6.30in)

Exposed Length: 130.00mm (5.12in)

Max Dia: 64.00mm (2.52in)

Notes: Used with 130-mm projectiles.



**Russian Fuze, Projectile, MT, VM30L**

Overall Length: 136.00mm (5.35in)

Exposed Length: 107.00mm (4.21in)

Max Dia: 64.00mm (2.52in)

Filler: Tetryl NEW: 59.00g (2.08oz)



**Russian Fuze, Projectile, MT, VM30**

Overall Length: 135.00mm (5.32in)

Exposed Length: 109.00mm (4.29in)

Max Dia: 64.00mm (2.52in)

Filler: Tetryl NEW: 59.00g (2.08oz)

Notes: Used with 85 and 100-mm projectiles.



**Russian Fuze, Projectile, MTSQ, V90**

Overall Length: 108.00mm (4.25in) Exposed Length: 61.00mm (2.40in) Max Dia: 40.00mm (1.57in)

Filler: Tetryl NEW: 149.00g (5.26oz)

## PROJECTILE FUZES



**Russian Fuze, Projectile, PD, AG30**  
 Overall Length: 62.00mm (2.44in)  
 Diameter: 20.00mm (0.79in)  
 Overall Weight: 51.00g (1.80oz)  
 Notes: Used in 30mm HEI projectiles



**Russian Fuze, Projectile, PD, KTM1**  
 Overall Length: 95.00mm (3.74in)  
 Exposed Length: 42.00mm (1.65in)  
 Max Dia: 40.00mm (1.57in)  
 Filler: Tetryl NEW: 9.00g (0.32oz)  
 Notes: Used with 57mm, 76mm and 85-mm HE projectiles.



**Russian Fuze, Projectile, PD, GO2**  
 Overall Length: 131.00mm (5.16in)  
 Exposed Length: 77.00mm (3.03in)  
 Diameter: 40.00mm (1.57in)  
 Overall Weight: 197.00g (6.95oz)  
 NEW: 9.00g (0.32oz)



**Russian Fuze, Projectile, PD, KTM1U**  
 Overall Length: 98.00mm (3.86in)  
 Exposed Length: 43.00mm (1.69in)  
 Diameter: 40.00mm (1.57in)  
 Filler: Tetryl NEW: 9.00g (0.32oz)



**Russian Fuze, Projectile, PD, KTM2**  
 Overall Length: 97.00mm (3.82in)  
 Exposed Length: 40.00mm (1.57in)  
 Diameter: 40.00mm (1.57in)  
 Filler: Tetryl Booster weight: 8.00g (0.28oz)



**Iranian Fuze, Projectile, PD, MASURAH 557  
 CCD**  
 Overall Length: 151.00mm (5.94in)  
 Exposed Length: 94.00mm (3.70in)  
 Diameter: 61.00mm (2.40in)



**Iraqi Fuze, Projectile, PD, RGM2**  
 Overall Length: 100.00mm (3.94in)  
 Exposed Length: 54.00mm (2.13in)  
 Max Dia: 40.00mm (1.57in)  
 Filler: Tetryl NEW: 15.00g (0.53oz)



**Former Yugoslavian Fuze, Projectile, PD, UTU  
 M557 (UTUM557)**  
 Overall Length: 150.00mm (5.91in)  
 Diameter: 94.00mm (3.70in)  
 Overall Weight: 876.00kg (1,927.20lbs)

## PROJECTILE FUZES



### Russian Fuze, Projectile, PDS, MG57

Overall Length: 83.00mm (3.27in)  
 Exposed Length: 48.00mm (1.89in)  
 Diameter: 41.00mm (1.61in)  
 Overall Weight: 334.00g (11.78oz)  
 Filler: Tetryl Booster: 13.00g (0.46oz)



### Russian Fuze, Projectile, PDS, A670M

Overall Length: 68.00mm (2.68in)  
 Exposed Length: 39.00mm (1.54in)  
 Diameter: 20.00mm (0.79in)  
 Overall Weight: 49.00g (1.73oz)  
 Notes: Used in 30mm HE-T and HEI projectiles.



### Russian Fuze, Projectile, PDS, A37U

Overall Length: 82.00mm (3.23in)  
 Diameter: 30.00mm (1.18in)  
 Overall Weight: 171.00g (6.03oz)



### Russian Fuze, Projectile, PDS, VMGM

Overall Length: 51.00mm (2.01in)  
 Diameter: 30.00mm (1.18in)  
 Overall Weight: 48.00g (1.69oz)  
 Filler: Tetryl NEW: 1.00g (0.04oz)



### Russian Fuze, Projectile, PIB, GK2

Overall Length: 97.00mm (3.82in)  
 Exposed Length: 76.00mm (2.99in)  
 Diameter: 40.00mm (1.57in)



### Russian Fuze, Projectile, PIB, GK2M

Overall Length: 122.00mm (4.80in)  
 Exposed Length: 97.00mm (3.82in)  
 Diameter: 41.00mm (1.61in)



### Russian Fuze, Projectile, PIB, GPV2

Overall Length: 98.00mm (3.86in)  
 Exposed Length: 56.00mm (2.20in)  
 Max Dia: 40.00mm (1.57in)  
 Notes: Used with 76, 85, 100, 122 and 152-mm HEAT projectiles.



### Former Yugoslavian Fuze, Projectile, PD, UTU M557 (UTUM557)

Overall Length: 150.00mm (5.91in)  
 Diameter: 94.00mm (3.70in)  
 Overall Weight: 876.00kg (1,927.20lbs)

## PROJECTILE FUZES



**Russian Fuze, Projectile, PD, V429**  
Overall Length: 104.00mm (4.09in)  
Exposed Length: 58.00mm (2.28in)  
Max Dia: 40.00mm (1.57in)  
Filler: Tetryl NEW: 15.00g (0.53oz)  
Notes: Used with 100, 122, and 130-mm projectiles.



**Former Yugoslavian Fuze, Projectile, PIBD, M69**  
Overall Length: 98.00mm (3.86in)  
Exposed Length: 56.00mm (2.20in)  
Diameter: 40.00mm (1.57in)  
NEW: 154.00kg (338.80lbs)



**Russian Fuze, Projectile, PTT, T5**  
Overall Length: 157.00mm (6.18in)  
Exposed Length: 128.00mm (5.04in)  
Max Dia: 64.00mm (2.52in)  
Filler: Tetryl NEW: 74.00g (2.61oz)



**Russian Fuze, Projectile, TSQ, D1U**  
Overall Length: 114.00mm (4.49in)  
Exposed Length: 70.00mm (2.76in)  
Diameter: 47.00mm (1.85in)  
Filler: RDX NEW: 12.00g (0.42oz)

## ROCKET FUZES



**Russian Fuze, Rocket, MT, TM120**  
Overall Length: 198.00mm (7.80in)  
Exposed Length: 141.00mm (5.55in)  
Max Dia: 64.00mm (2.52in)



**Russian Fuze, Rocket, PD, DKZB**  
Overall Length: 196.00mm (7.72in)  
Exposed Length: 140.00mm (5.51in)  
Diameter: 63.00mm (2.48in)  
Overall Weight: 935.00g (32.98oz)  
Filler: Tetryl Booster weight: 88.00g (3.10oz)

## ROCKET FUZES



**Russian Fuze, Rocket, PD, MRVU**

Overall Length: 36.00mm (1.42in)  
 Exposed Length: 141.00mm (5.55in)  
 Diameter: 39.00mm (1.54in)  
 Max Diameter: 64.00mm (2.52in)  
 Overall Weight: 299.00g (10.55oz)  
 Notes: Used with 122-mm rockets.



**Russian Fuze, Rocket, PD, V25**

Overall Length w/Cover: 113.00mm (4.45in)  
 Exposed Length: 68.00mm (2.68in)  
 Max Dia: 40.00mm (1.57in)  
 Filler: Tetryl NEW: 25.00g (0.88oz)



**Russian Fuze, Rocket, PD, V5K**

Overall Length: 125.00mm (4.92in)  
 Exposed Length: 110.00mm (4.33in)  
 Exposed Length w/o cap: 74.00mm (2.91in)  
 Diameter: 40.00mm (1.57in)  
 Notes: Spitback fuze that is used with both HE-FRAG, HEAT-FRAG and HEAT 57mm Rockets



**Russian Fuze, Rocket, PDS, V5M1**

Overall Length: 157.00mm (6.18in)  
 Exposed Length w/o cap: 52.00mm (2.05in)  
 Diameter: 40.00mm (1.57in)  
 Overall Weight: 260.00g (9.17oz)  
 Notes: Used with HE and HE-FRAG 57mm Rockets



**Russian Fuze, Rocket, PD, 9K1608**

Overall Length: 75.00mm (2.95in)  
 Diameter: 43.00mm (1.69in)  
 NEW: 120.00g (4.23oz) Notes: Base element used in 80mm and 57mm HEAT rockets



**Russian Fuze, Rocket, PIBD, VP18**

Overall Length: 74.00mm (2.91in)  
 Diameter: 37.00mm (1.46in)  
 Notes: Base element used in PG-18

# SECTION J

## BOMB & SUB-MUNITIONS



## BOMBS (Russia)

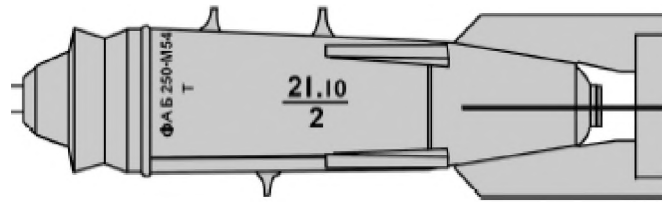

### Russian Bomb, 250kg, HE, FAB250M54

Overall Length: 1,500.00mm (59.06in)  
 Diameter: 325.00mm (12.80in) Overall Weight: 250.00kg  
 (550.00lbs) Filler: TNT NEW: 97.00kg (213.40lbs) Fuze: Nose & Tail

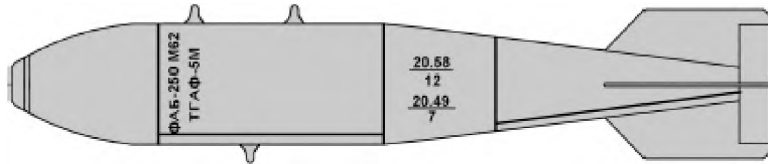

### Russian Bomb, 250kg, HE, FAB 250 M62

Length w/o Fuze: 2,000.00mm (78.74in)  
 Diameter: 300.00mm (11.81in) Overall Weight: 227.00kg (499.40lbs) NEW: 107.00kg (235.40lbs)  
 Fuze: Nose

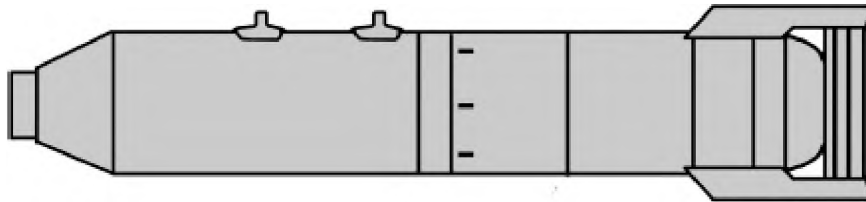

### Russian Bomb, 250kg, HE-FRAG, OFAB 250ShL (Retarded)

Overall Length: 1,991.00mm (78.39in)  
 Diameter: 325.00mm (12.80in) Overall Weight: 266.00kg (585.20lbs)  
 NEW: 93.70kg (206.14lbs) Fuze: Nose & Tail

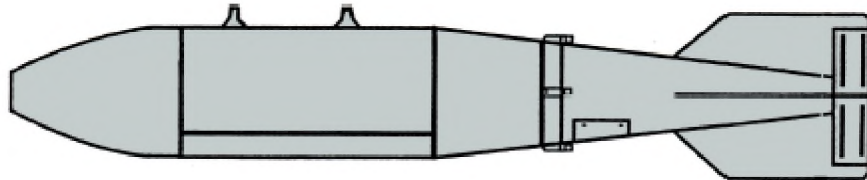

### Russian Bomb, 500kg, HE, FAB 500 M62

Overall Length: 2,425.00mm (95.47in)  
 Diameter: 400.00mm (15.75in) Overall Weight: 498.00kg (1,095.60lbs)  
 Filler: RDX/TNT NEW: 213.00kg (468.60lbs) Fuze: Nose & Tail

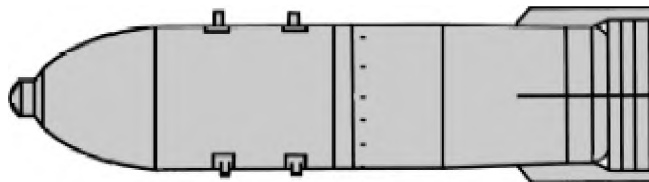

### Russian Bomb, 500kg, HE, FAB 500 ShL (Retarded)

Overall Length: 2,220.00mm (87.40in)  
 Diameter: 450.00mm (17.72in) Overall Weight: 515.00kg (1,133.00lbs)  
 NEW: 221.00kg (486.20lbs) Fuze: Nose & Tail  
 Notes: Parachute retarded

## BOMBS (Russia)

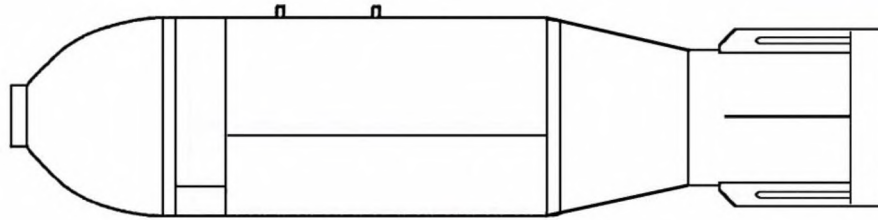

**Russian Bomb, FAE, 500-KG, OBAD-500PM**  
Len: 2280mm Dia: 500mm

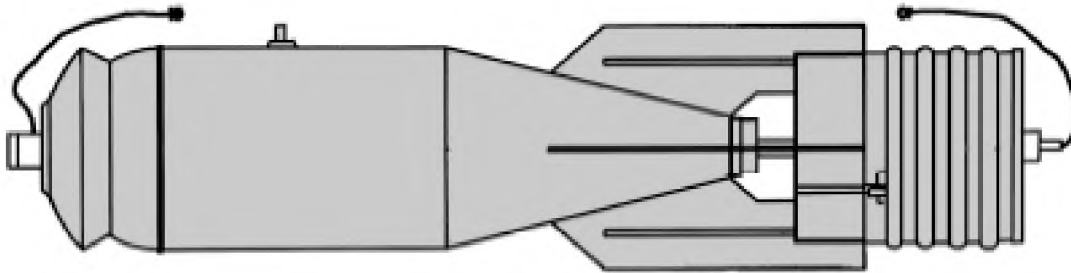

**Russian Bomb, 100kg, HE-FRAG, OFAB100-120 (Retarded)**  
Length w/ Parachute Pack: 1,300.00mm (51.18in)  
Diameter: 273.00mm (10.75in) Overall Weight w/Parachute Pack: 133.00kg (292.60lbs)  
Filler: TNT NEW: 42.00kg (92.40lbs) Fuze: Nose

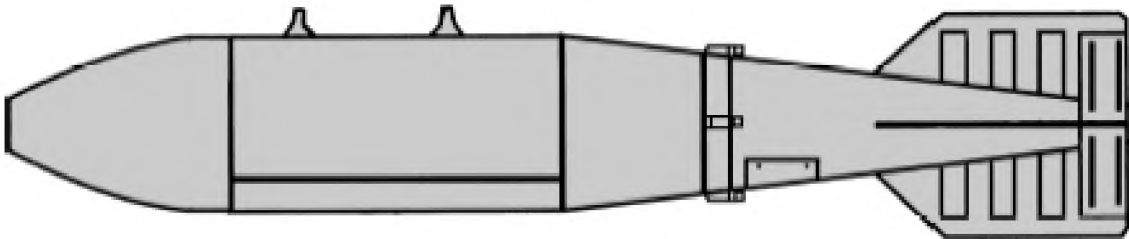

**Russian Bomb, 250kg, HE-FRAG, OFAB250T**  
Overall Length: 2,050.00mm (80.71in)  
Diameter: 300.00mm (11.81in) Overall Weight: 256.00kg (563.20lbs)  
NEW: 95.70kg (210.54lbs) Fuze: Nose & Tail

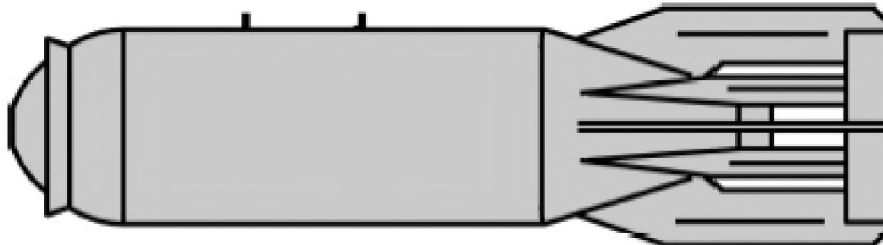

**Russian Bomb, 250kg, HE-FRAG, OFAB250-270**  
Overall Length: 1,456.00mm (57.32in)  
Diameter: 325.00mm (12.80in) Overall Weight: 266.00kg (585.20lbs)  
Filler: TNT NEW: 97.00kg (213.40lbs) Fuze: Nose & Tail

## BOMBS (Russia)

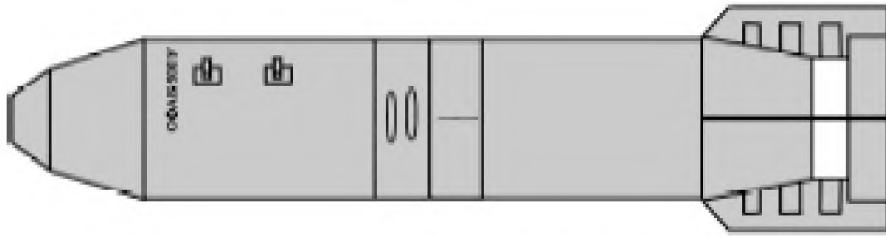

**Russian Bomb, 500kg, HE-FRAG, OFAB500U (Retarded)**

Overall Length: 2,300.00mm (90.55in)

Diameter: 400.00mm (15.75in) Overall Weight: 515.00kg (1,133.00lbs)

NEW: 159.00kg (349.80lbs) Fuze: Nose & Tail – Airburst, surface, and subsurface penetration capability.

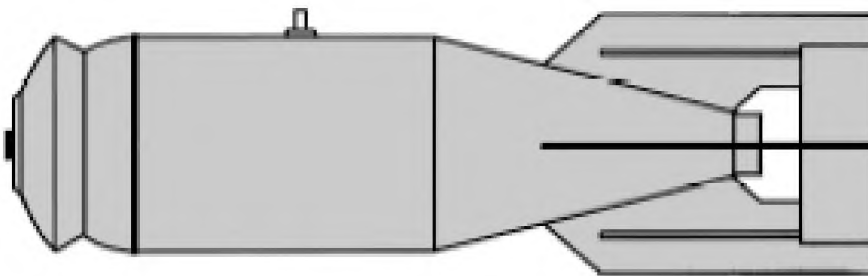

**Russian Bomb, 100kg, HE-FRAG, OFAB100-120**

Diameter: 273.00mm (10.75in) Overall Weight: 120.00kg (264.00lbs)

Filler: TNT NEW: 42.00kg (92.40lbs)

Fuze: Nose & Tail

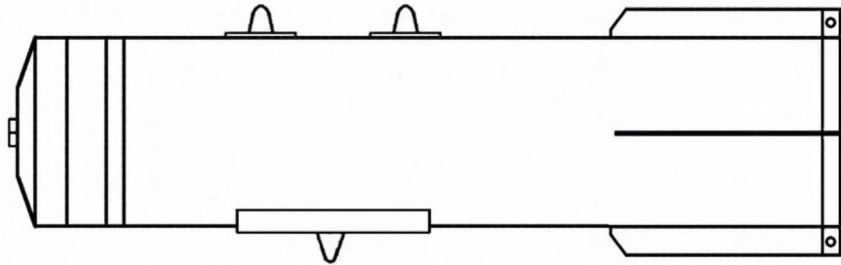

**Russian Bomb, Illumination, SAB-250-200**

Len: 1500mm Dia: 325mm

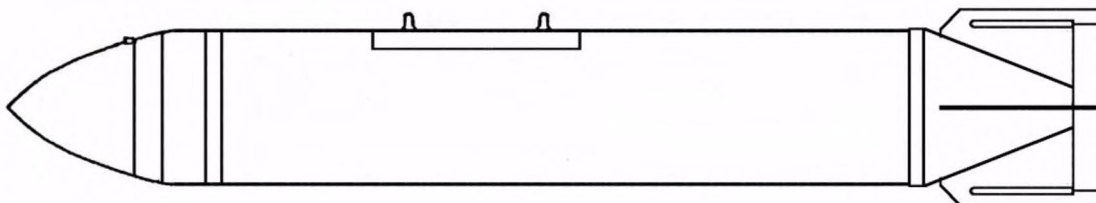

**Russian Bomb, Illumination, SAB-250T**

Len: 2400mm Dia: 325mm

## BOMBS (Russia)

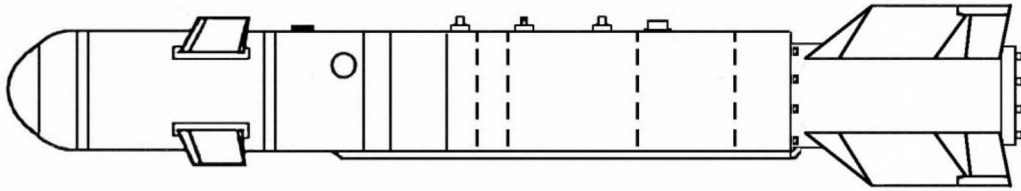

Russian Bomb, Guided, KAB-500Kr  
Len: 3035mm Dia: 350mm

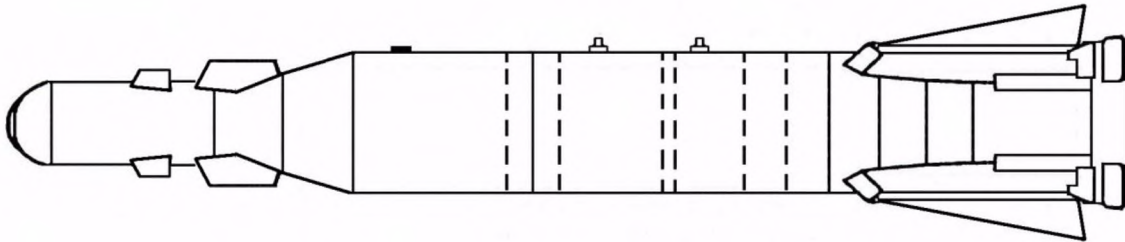

Russian Bomb, Guided, KAB-1500Kr  
Len: 4600mm Dia: 580mm

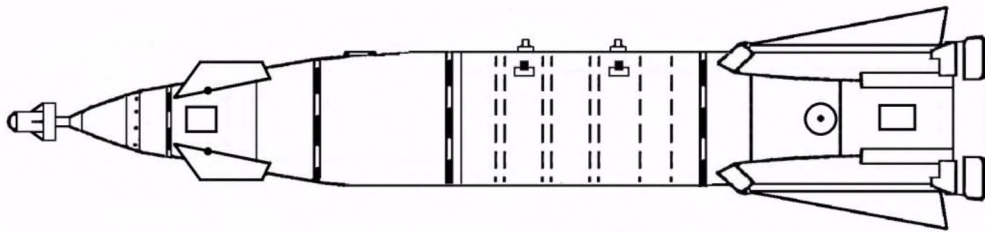

Russian Bomb, Guided, KAB-1500L-F  
Len: 4600mm Dia: 580mm

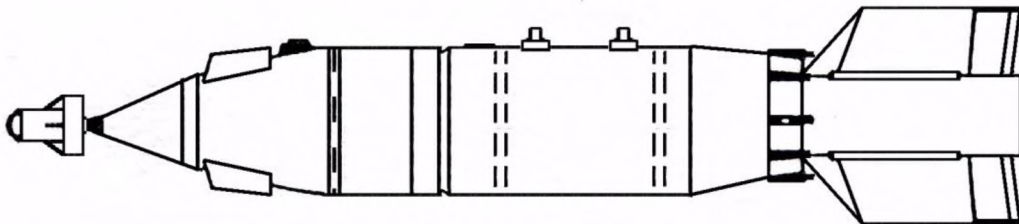

Russian Bomb, Guided, KAB-1500L-Pr  
Len: 4600mm Dia: 580mm

## BOMBS (Russia)

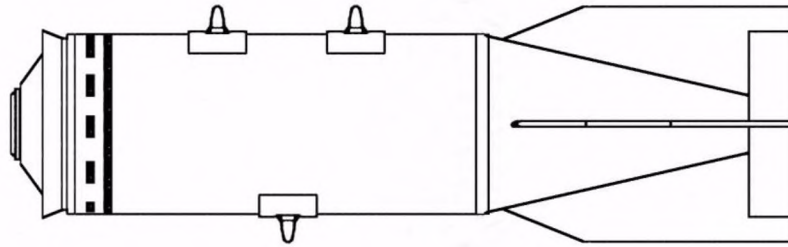

**Russian Bomb, Cluster, RBK 250 ZAB 2.5m**  
Len: 1492mm Dia: 325mm

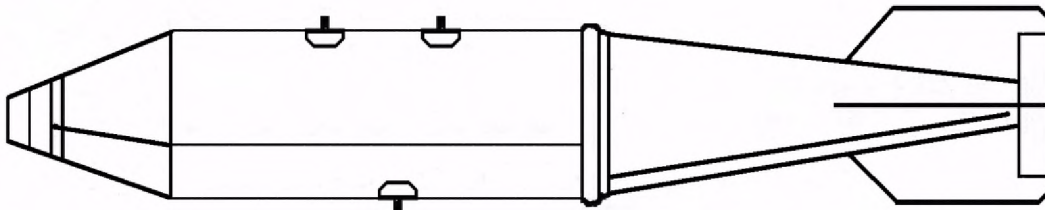

**Russian Bomb, Cluster, RBK 250-275**  
Len: 2120mm Dia: 325mm

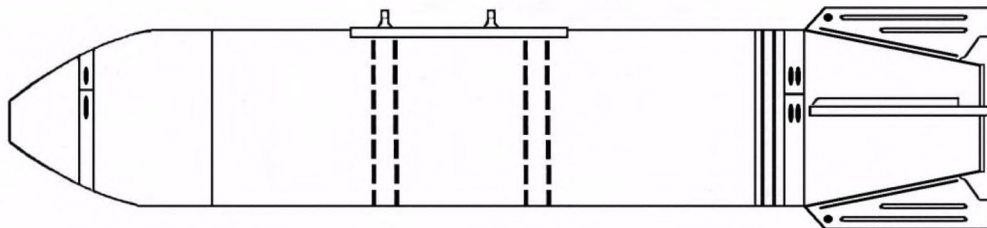

**Russian Bomb, Cluster, 500 Kg, RBK 500U OFAB 50UD**  
Len: 2500mm Dia: 450mm

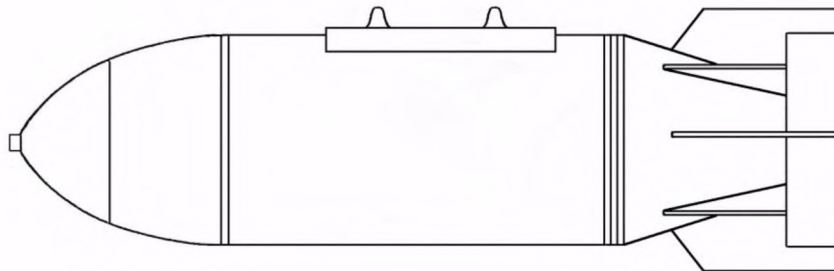

**Russian Bomb, Cluster, 500 Kg, RBK 500 PTAB-1M**  
Len: 1954mm Dia: 450mm

## BOMBS (Iraqi)



### **Iraqi Bomb, 250kg, HE, FARIS**

Overall Length: 1,920.00mm (75.59in)

Diameter: 300.00mm (11.81in)

Filler: Main Charge: TNT, RDX, Aluminum, weight unknown

Notes: Bomb is believed to have a nose well and possibly a tail fuze well.



### **Iraqi Bomb, 250kg, HE, KAAKAA250**

Overall Length: 1,514.00mm (59.61in)

Diameter: 325.00mm (12.80in) Overall Weight: 250.00kg (550.00lbs)

Filler: Main Charge: TNT Fuze: Impact, Nose & Tail

Notes: APERS



### **Iraqi Bomb, 1500kg, HE, NASR1500**

Overall Length: 3,320.00mm (130.71in)

Diameter: 630.00mm (24.80in) Overall Weight: 1,500.00kg (3,300.00lbs)

Filler: Main Charge: TNT, 658kg NEW: 658.00kg (1,447.60lbs) Fuze: Nose & Tail

Notes: Bombs of this type have an offset tail fuze well with a filler plug adjacent to the tail fuze well.



### **Iraqi Bomb, 880kg, HE, NASR28**

Overall Length: 3,730.00mm (146.85in)

Diameter: 457.00mm (17.99in) Overall Weight: 880.00kg (1,936.00lbs)

Filler: Main Charge: TNT/Aluminum, weight unknown

Fuze: Nose & Tail

## BOMBS (Iraqi)



### **Iraqi Bomb, 3000kg, HE, NASR3000**

Overall Length: 3,320.00mm (130.71in)

Diameter: 820.00mm (32.28in) Overall Weight: 3,000.00kg (6,600.00lbs)

Filler: Main Charge: TNT, 1,350kg NEW: 1,350.00kg (2,970.00lbs)

Fuze: Nose & Tail Notes: The bomb has one nose fuze and possibly two tail fuze wells.

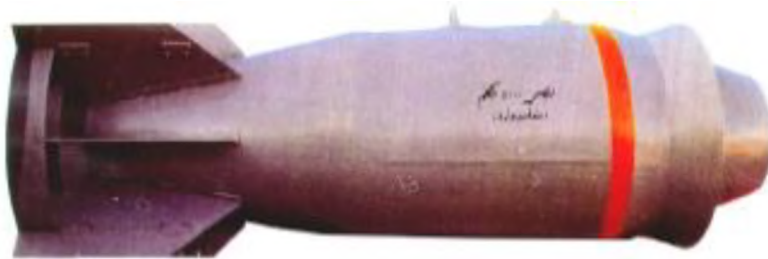

### **Iraqi Bomb, 5000kg, HE, NASR5000**

Overall Length: 3,320.00mm (130.71in)

Diameter: 1,060.00mm (41.73in) Overall Weight: 5,000.00kg (11,000.00lbs)

Filler: HE Fuze: Nose & Tail



### **Iraqi Bomb, 500kg, HE, NASR7**

Overall Length: 2,419.00mm (95.24in)

Diameter: 400.00mm (15.75in) Overall Weight: 500.00kg (1,100.00lbs)

Filler: Main Charge: TNT Unknown qty Fuze: Nose & Tail



### **Iraqi Bomb, 500kg, Penetration, NASR500P1**

Overall Length: 2,200.00mm (86.61in)

Diameter: 350.00mm (13.78in) Overall Weight: 500.00kg (1,100.00lbs)

Filler: HE Fuze: Tail

## BOMBS CLUSTER (Russia)

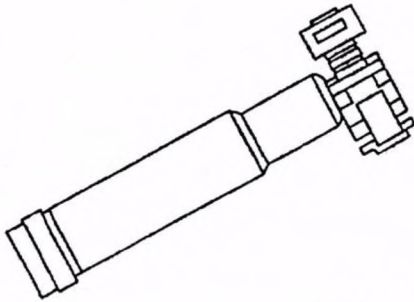

Russian Submunition, PTAB 1M  
Len: 260mm Dia: 42mm

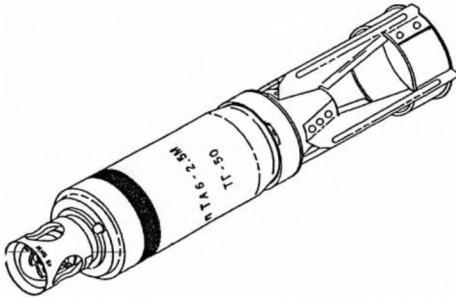

Russian Submunition, P-TAB 2.5m  
Len: 395mm Dia: 69mm, Fuze: AV-524M

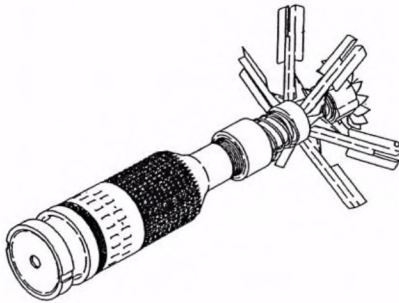

Russian Submunition, PTAB 2.5 KO  
Len: 300mm Dia: 60mm



## BOMBS SUB-MUNITION



**Russian Submunition, AO-1 SCH**  
Len: 141mm Dia: 48mm

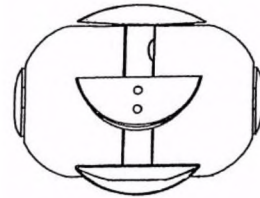

**Russian Submunition, AO 2.5 RTM**  
Len: 143mm Dia: 90mm



**Former Yugoslavian Submunition, Dual Purpose, HE, KB1**  
Overall Weight: 235.00g (8.29oz)  
Filler: RDX NEW: 35.00g (1.23oz)  
Notes: Used with rockets.



**U.S. Sub muniton, Dual Purpose, M42**  
Overall Height: 81.00mm (3.19in)  
Diameter: 38.00mm (1.50in)  
Overall Weight: 198.00g (6.98oz)  
Weapon Using: MLRS Rocket, M483 155mm Projo  
Filler: A-5 Main Charge: 33.00g (1.16oz)  
Notes: The M42 also carries the designation M46 and M77. Sub munitions are identical except for weapons system used in.



**U.S. Sub muniton, HEAT, MK118**  
Overall Length: 343.00mm (13.50in)  
Diameter: 53.00mm (2.09in)  
Overall Weight: 590.00g (20.81oz)  
Weapon Using: MK 7 Dispenser  
Filler: Comp B or Octol Main Charge: 181.00g (6.38oz)



**U.S. Sub muniton, HEAT, FRAG, BLU97AB**  
Length: 168.00mm (6.61in)  
Diameter: 64.00mm (2.52in)  
Overall Weight: 1.50kg (3.30lbs)  
Filler: Cyclotol and PBXN-107  
Main Charge: 327.00g (11.53oz) Notes: Used in SUU-65, CBU 87 and CBU-103 Dispensers and AGM-109 Tomahawk

# SECTION K

## MISSILES



# ANTI-TANK GUIDED MISSILES

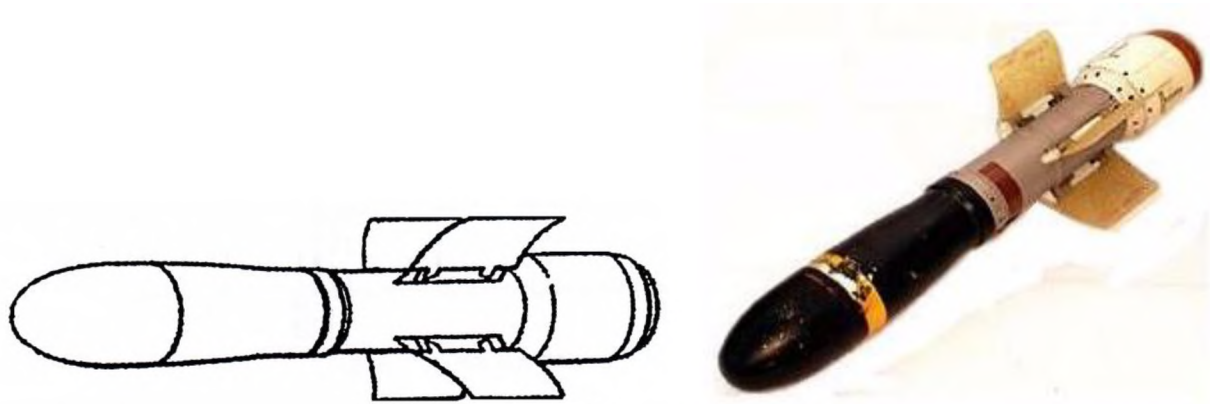

**Milan ( France )**  
Len: 755mm Dia: 103mm

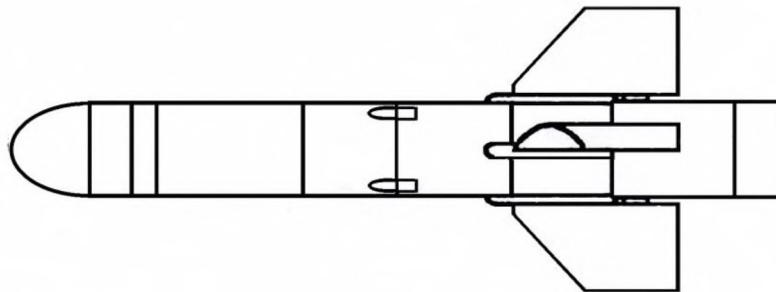

**Red Arrow 8A ( China )**  
Len: 860mm Dia: 120m

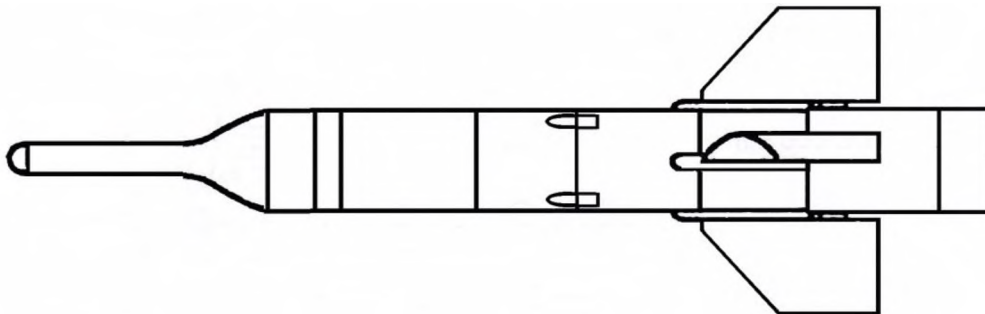

**Red Arrow 8C ( China )**  
Len: 1100mm Dia: 120m

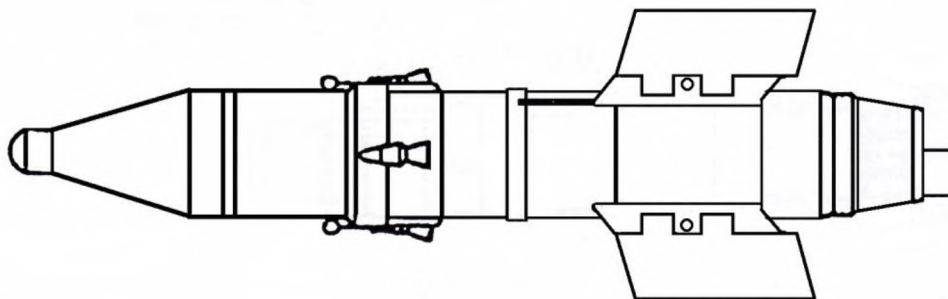

**AT-3 Sagger ( CIS )**  
Len: 860mm Dia: 125m

# ANTI-TANK GUIDED MISSILES

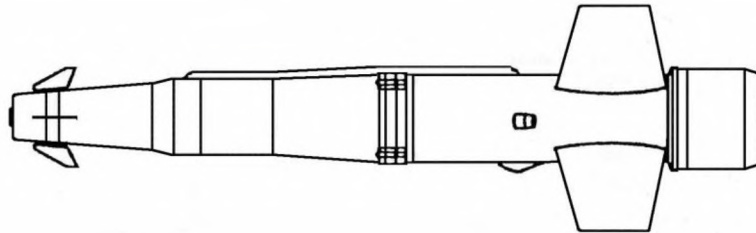
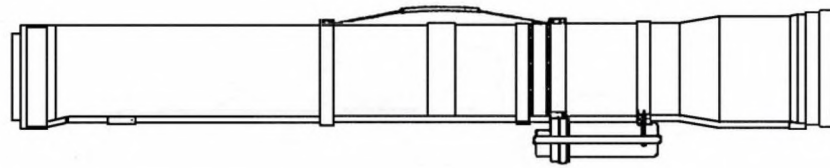

**AT-4A Spigot (CIS)**  
Length: 863mm Dia: 120mm

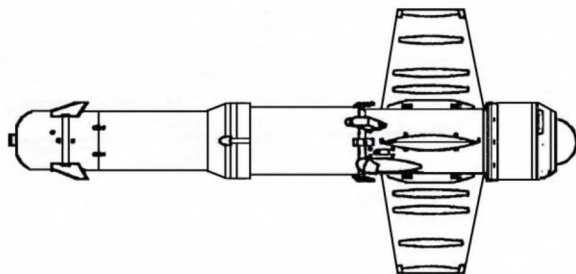
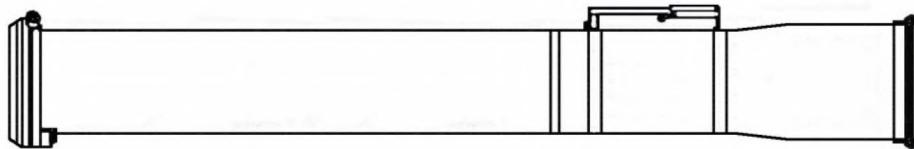

**AT5 A Spandrel (CIS)**  
Length: 955mm Dia: 135mm

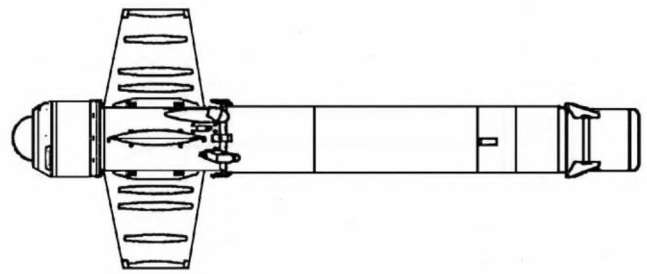

**AT5 B Spandrel (CIS)**  
Length: 1150mm Dia: 135mm

## ANTI-TANK GUIDED MISSILES

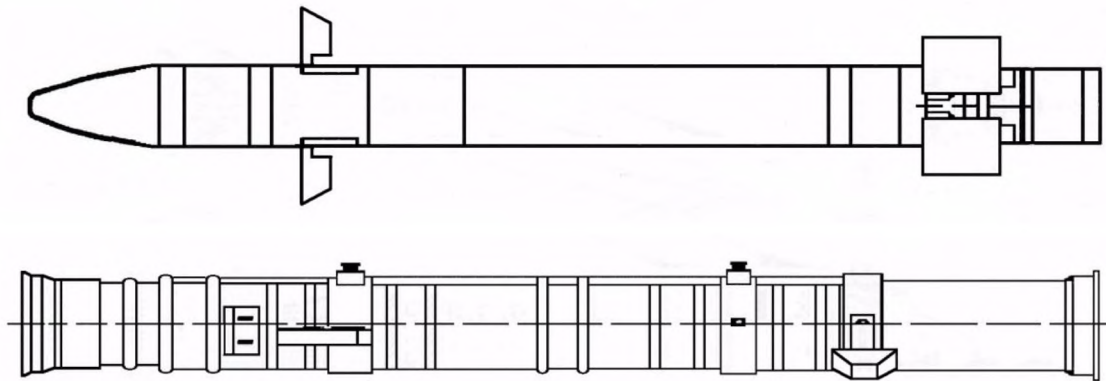

**AT-6 ( Russian )**  
Length: 1600mm Dia: 128mm

## SHOULDER-FIRED SURFACE-TO-AIR MISSILE

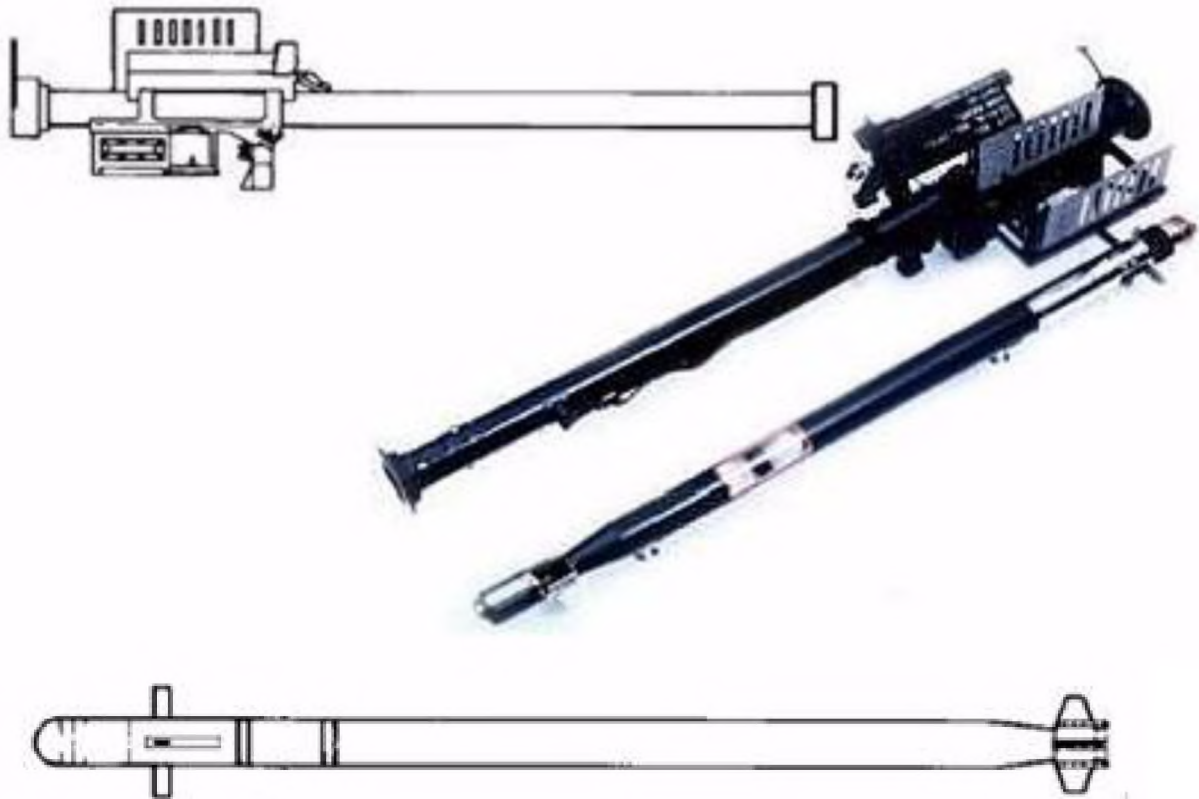

**Stinger ( US )**  
Length: 1.37m Dia: 70mm

## SHOULDER-FIRED SURFACE-TO-AIR MISSILE

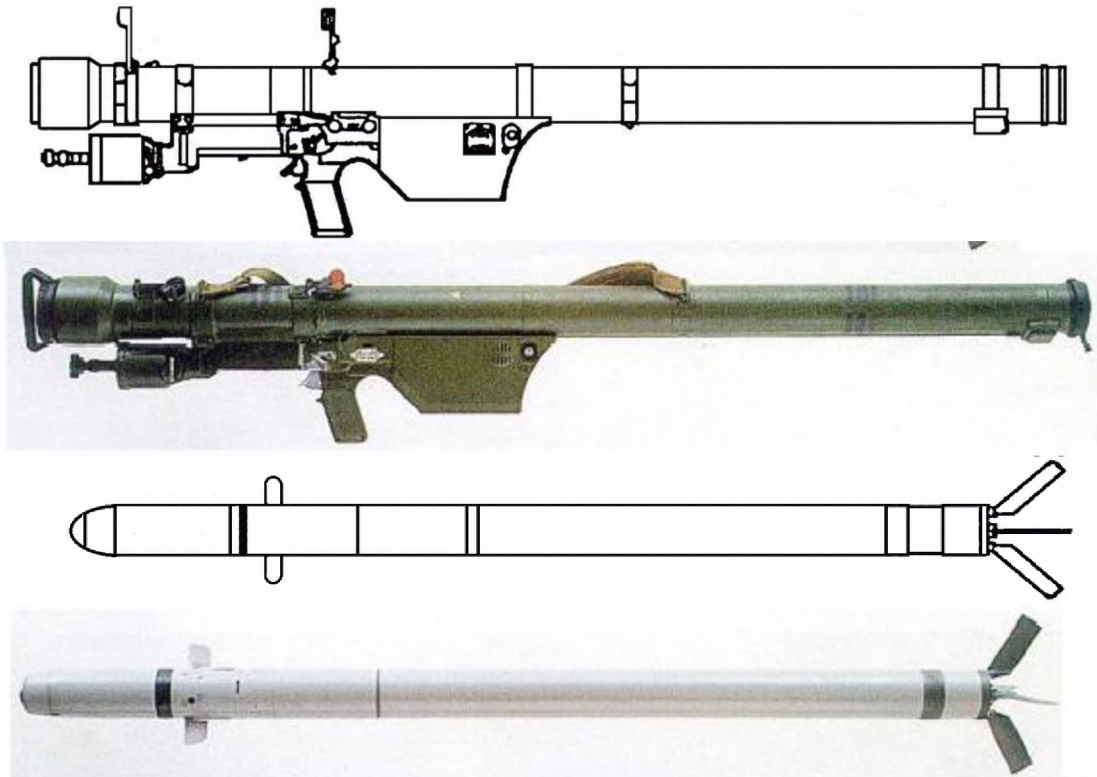

**Russian Missile, Ground-to-Air, 9M32, SA-7**

Overall Length: 1,440.00mm (56.69in)

Diameter: 72.00mm (2.83in) Overall Weight: 15.00kg (33.00lbs)

RDX: 0.37kg (0.81lbs) Notes: UNFIRED MISSILE CONTAINS APPROX 3lbs OF PROPELLANT

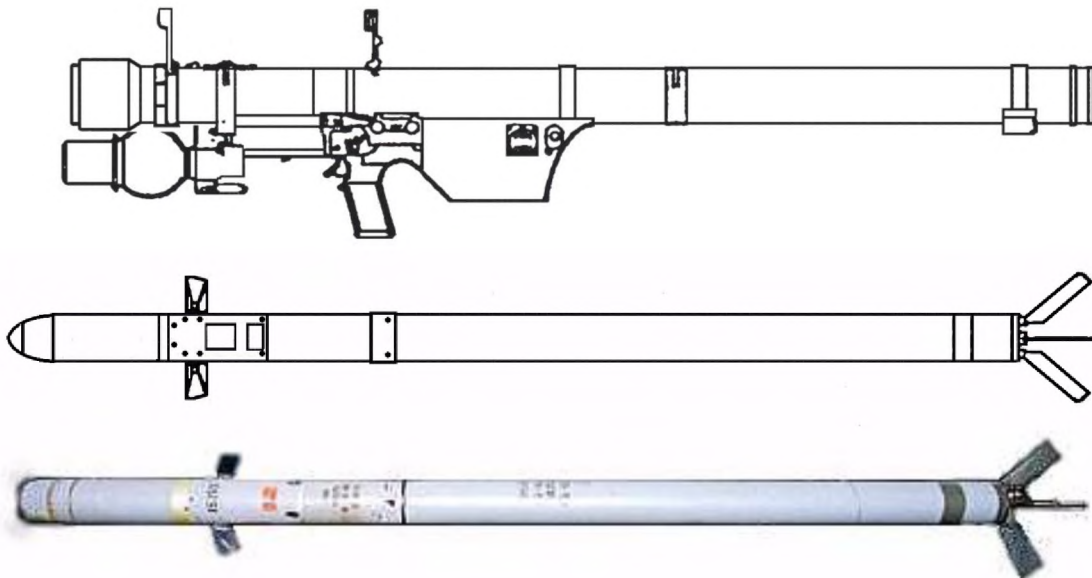

**Russian Missile, Ground-to-Air, 9M36, SA-14**

Length: 1,470.00mm (57.87in)

Diameter: 72.00mm (2.83in) Overall Weight: 16.00kg (35.20lbs)

NEW: 0.37kg (0.81lbs)m

## SHOULDER-FIRED SURFACE-TO-AIR MISSILE

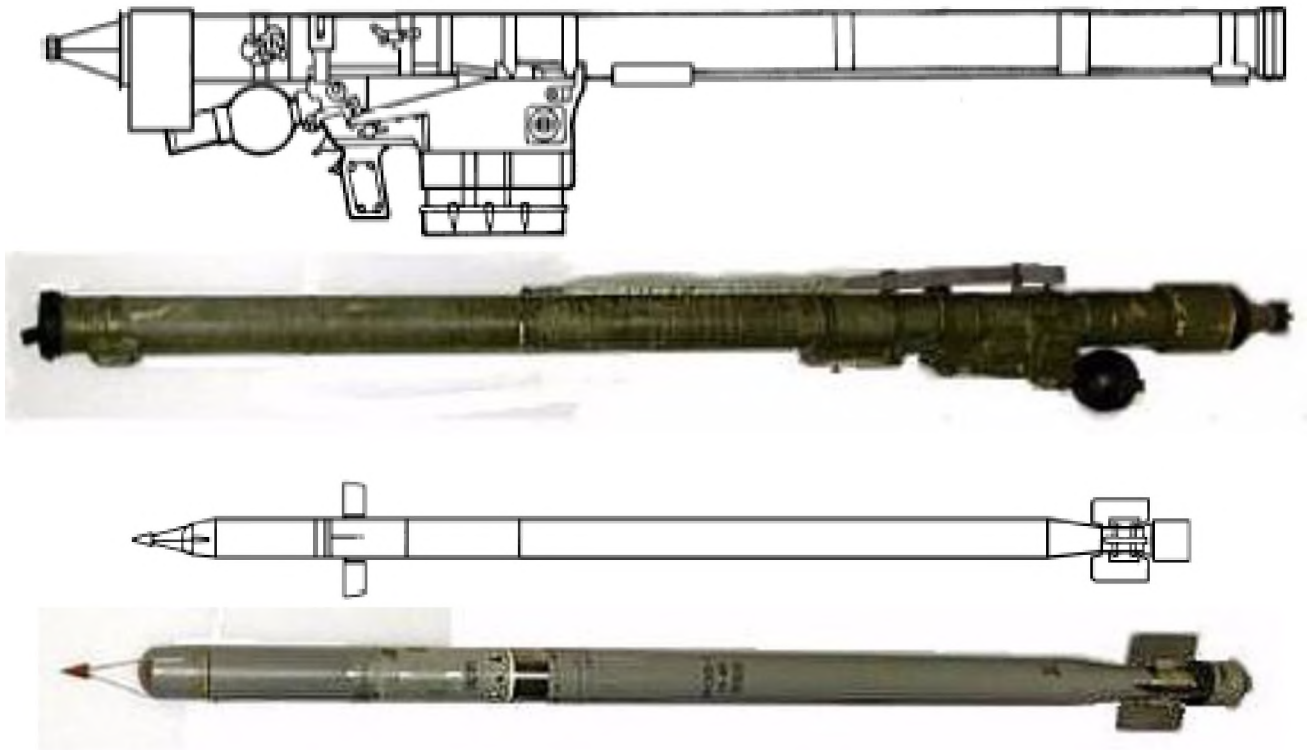

**Russian Missile, Ground-to-Air, 9M313, SA-16**  
Overall Length: 1,593.00mm (62.72in)  
Diameter: 72.00mm (2.83in)  
Overall Weight: 17.90kg (39.38lbs) NEW: 0.40kg (0.88lbs)

## SURFACE-TO-AIR MISSILE

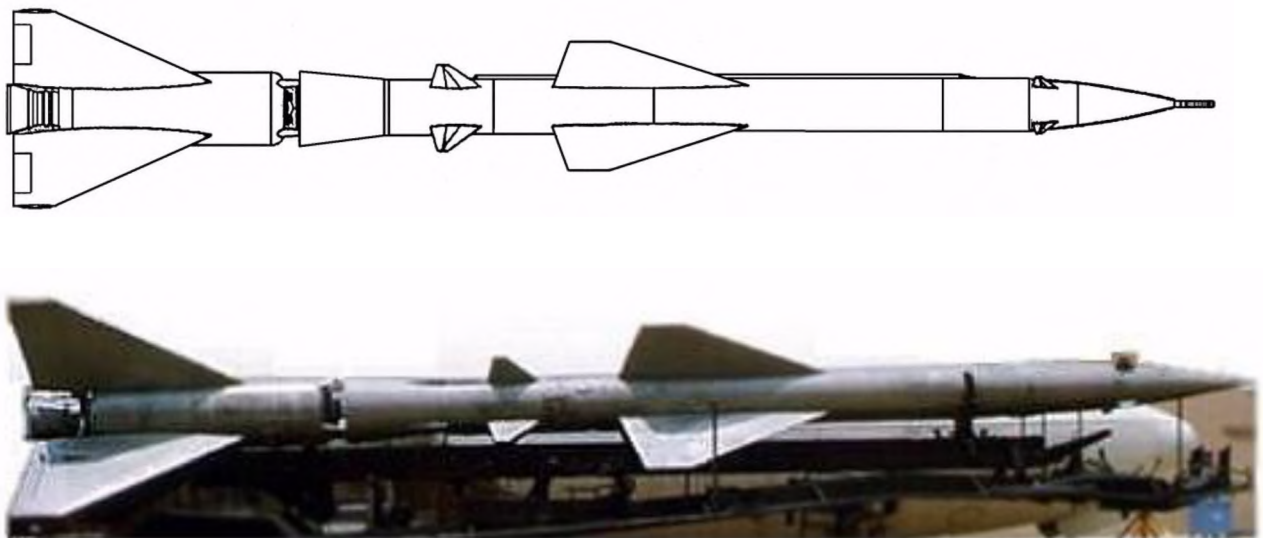

**SA-2 ( Russian )**  
Length: 10.78m Dia: 500mm

## SURFACE-TO-AIR MISSILE

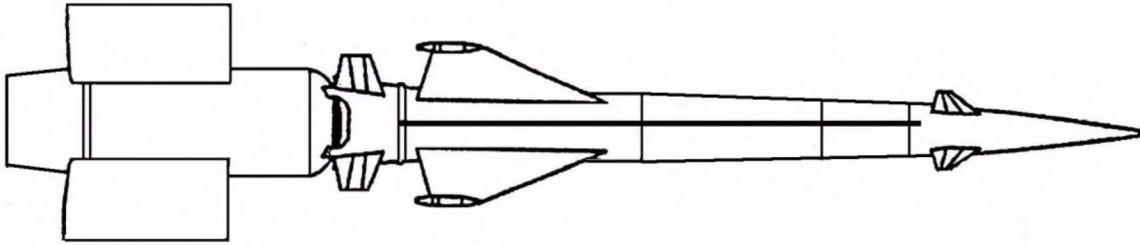

**SA-3 ( Russian )**  
Length: 6.1m Dia: 375mm

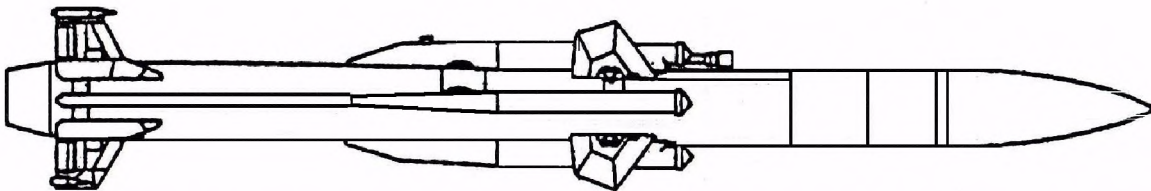

**SA-6 ( Russian )**  
Length: 5.8m Dia: 330mm

## SURFACE-TO-AIR MISSILE

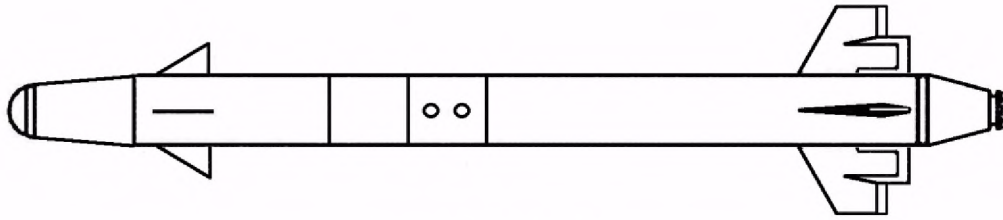

**SA-9 ( Russian )**  
Length: 2230mm Dia: 130mm

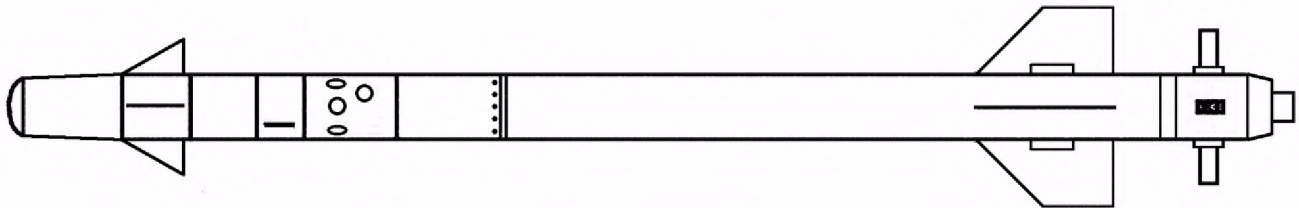

**SA-13 ( Russian )**  
Length: 2340mm Dia: 120mm



## GROUND - TO - GROUND MISSILE

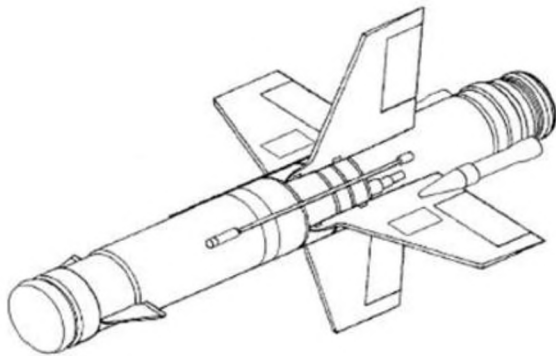

**Russian Missile, Ground-to-Ground, HEAT, AT2**  
Overall Length: 1,160.00mm (45.67in)  
Diameter: 148.00mm (5.83in)  
Overall Weight: 25.00kg (55.00lbs) Fuze: Piezoelectric

## GROUND - TO - GROUND MISSILE

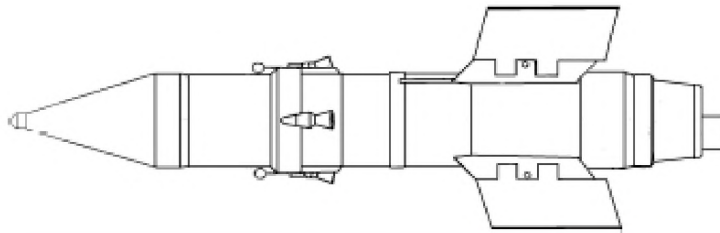

### Russian Missile, Ground-to-Ground, HEAT, AT3

Overall Length: 864.00mm (34.02in)

Diameter: 120.00mm (4.72in) Filler: RDX Fuze: Piezoelectric

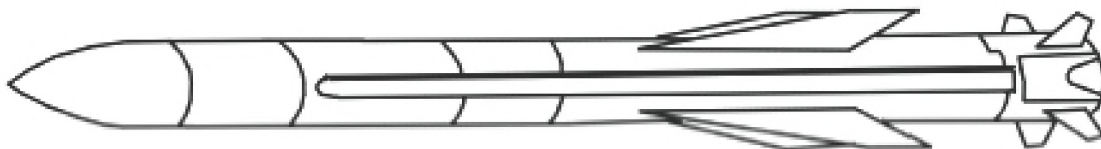

### French Missile, Ground-to-Ground, HE, MM38 (EXOCET)

Overall Length: 5,200.00mm (204.72in)

Diameter: 348.00mm (13.70in)

Filler: Main Charge: Hexolite , 42.5kg Fuze: Impact

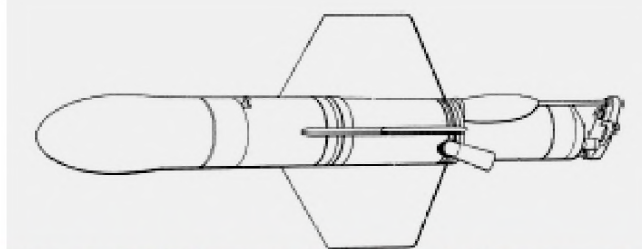

### French Missile, Ground-to-Ground, HE, SS12

Overall Length: 1,860.00mm (73.23in)

Diameter: 210.00mm (8.27in)

Overall Weight: 77.00kg (169.40lbs) Warhead Weight: 29.00kg (63.80lbs) Fuze: Impact